

YOKE[®]

Safety is our first priority[™]

DA[™]
Offshore Lifting

DNV 2.7-1 TYPE APPROVAL

Offshore Container Lifting Operation



Catalog No. 8-2023 Offshore



DATM

Offshore Lifting

Offshore Container Lifting Operation.

The Features of YOKE DA™ Offshore Container Lifting Series

YOKE DA™ Series are manufactured to meet the requirements of DNV 2.7-1 for offshore container lifting to fulfill the need for the critical requirements of charpy impact, strength and ductility.

Lower Temperature Demand

YOKE DA™ Series are designed to withstand impacts in extreme environments down to maximum -40° C.

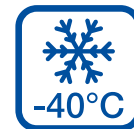

Higher Safety Factors

YOKE DA™ Shackles have a design factor of 6 for Grade 6 Shackles and a design factor of 8 for Grade 8 shackles, and YOKE DA™ Master Link & Assembly have a design factor of 5 to enable them to operate in the harshest environments.

DNV 2.7-1 Specified Test Certificate

Test certificate with material and manufacturing process specified in DNV 2.7-1 for complete traceability.

To perform in the harshest weather and roughest sea conditions, YOKE DA™ Series are specially designed, manufactured and tested for the operating in the offshore container industry.

Quality Management System and Product Type Approval:



www.yoke.net/thirdpartycertificate

Statement of LIMITED WARRANTY

Purchaser and YOKE expressly agree that YOKE's warranty with respect to sale of its products is LIMITED solely to YOKE's choice of repair, replacement or refund of the purchase price of any product.

Purchaser and YOKE expressly agree that the remedies provided in this section are the purchaser's exclusive remedies in connection with the purchase or use of the product. Purchaser and YOKE expressly agree that in no event shall YOKE be liable for any incidental or consequential damages in connection with the purchase or use of the product.

All other warranties, including express warranties and the implied warranties of merchantability and fitness for a particular purpose are hereby disclaimed. Purchaser hereby waives all other warranties, rights and remedies arising by law or otherwise including, but not limited to, express warranties, the implied warranty of merchantability, any implied warranties arising from course of performance, course of dealing or usage of trade, and implied warranty of fitness for a particular purpose. Additionally, yoke hereby disclaims any of its obligations or liabilities arising from statute, warranty, contract, tort or negligence. Any modification made to yoke products will void the limited warranty where applicable, and will also void any third party accreditations that may apply such as abs, dnv, etc.

Complete Agreement: This Warranty between purchaser and YOKE is complete. All prior or contemporaneous discussions, representations and/or understanding are merged into this Warranty.

All prior or contemporaneous agreements between the parties are superseded by this Warranty. Choice of Law: Any dispute about the interpretation of this Warranty shall be governed by the laws of Taiwan, The Republic of China.

Resolution of Disputes: Purchaser and YOKE expressly agree that any dispute arising out of the purchase, use or operation of the purchased product shall, upon written notice to the other party, be resolved through binding arbitration. The arbitration shall be governed by the then existing rules of the Arbitration Association of The Republic of China. The location of any arbitration shall be Taichung, Taiwan, The Republic of China. The substantive laws of The Republic of China shall govern the arbitration to the extent they are not in conflict with the then existing rules of the Arbitration Association of The Republic of China. In no event shall YOKE be liable for incidental or consequential damages as part of the arbitration award. The award, decision, or filing rendered by the arbitration shall be final, and judgment may be entered upon it in accordance with the applicable law in any court having appropriate jurisdiction.

Quality Control, Testing, and Detecting during manufacturing

YOKE runs a constant and strict production facility with quality control in every manufacturing stage from raw materials to the completed product. YOKE is an ISO 9001 certified company and has Type Approval by the major international authorities from Deutsche Gesetzliche Unfallversicherung (DGUV) , ABS, API, and DNV which ensure the quality research and development (R&D) department and unsurpassed product engineering.

■ Magnaflux Crack Detection:

All forged components are individually magnaflux detected after heat treatment.

■ Proof Load Testing:

YOKE Yellow Points are proof load qualified to 2.5 times the Working Load Limit within 1% permanent deformation.

■ Dynamic Fatigue Testing:

Batch samples of YOKE Yellow Points are Dynamic Fatigue Tested to 20,000 cycles at 1.5 times the Working Load Limit.

■ Ultimate Breaking Load Testing:

Batch samples are tested in a static tensile testing machine until failure. Minimum ultimate force equals to the Working Load Limit times safety factor.

■ Spectrographic Analysis:

To assure of the proper metallurgy content of all raw materials.

TYPE APPROVAL CERTIFICATE

This is to certify:

That the lifting set components for offshore containers and portable offshore units

with type designation(s)
Master Link - Type DA-001
Master Link - Type DA-001F
Master Link Assembly - Type DA-007
Master Link Assembly - Type DA-007F

Issued to
Yoke Industrial Corp. Ltd.
Taichung, Taiwan

is found to comply with
DNV GL standard DNVGL-ST-E271 – 2.7-1 Offshore containers, August 2017
DNV GL standard DNVGL-ST-E273 – 2.7-3 Portable offshore units, December 2016
EN 1677-4 Components for slings – Safety – Part 4: Links, Grade 8
ISO 10855-2:2018 Offshore containers and associated liftings sets – Part 2: Design, manufacture and testing of lifting sets
IMO/MSC Circular 860

Application :

Grade 8 links for lifting sets for offshore containers or portable offshore units

Issued at **Aberdeen** on **2020-11-09**

This Certificate is valid until **2025-11-08** .
 DNV GL local unit: **Kaohsiung**

Approval Engineer: **Alex Doig**

for **DNV GL**
 for DNV GL UK Ltd.
 This document has been digitally signed and will therefore not have handwritten signatures
 Legg Elisabeth
 Principal Engineer

Elisabeth Legg
Principal Engineer

This Certificate is subject to terms and conditions overleaf. Any significant change in design or construction may render this Certificate invalid. The validity date relates to the Type Approval Certificate and not to the approval of equipment/systems installed.

LEGAL DISCLAIMER: Unless otherwise stated in the applicable contract with the holder of this document, or following from mandatory law, the liability of DNV GL AS, its parent companies and subsidiaries as well as their officers, directors and employees ("DNV GL") arising from or in connection with the services rendered for the purpose of the issuance of this document or reliance thereon, whether in contract or in tort (including negligence), shall be limited to direct losses and under any circumstance be limited to 300,000 USD.



Form code: TA 281

Revision: 2020-03

www.dnvgl.com

Page 1 of 5

© DNV GL 2014. DNV GL and the Horizon Graphic are trademarks of DNV GL AS.

DNV·GL

Certificate No:
TAS0000241

TYPE APPROVAL CERTIFICATE

This is to certify:

That the Lifting set for Offshore containers and Portable Offshore Units

with type designation(s)

Bolt Pin Anchor Shackles - Type DA-808 - Design Temperature -40°C

Bolt Pin Anchor Shackles - Type DA-838 - Design Temperature -40°C

Issued to

Yoke Industrial Corp.

Taichung, Taiwan

is found to comply with

DNV GL standard DNVGL-ST-E271 – 2.7-1 Offshore containers, August 2017

DNV GL standard DNVGL-ST-E273 – 2.7-3 Portable offshore units, December 2016

EN 13889 Forged steel shackles for general lifting purposes - Dee shackles and Bow shackles - Grade 6 - Safety

ISO 10855-2:2018 Offshore containers and associated liftings sets – Part 2: Design, manufacture and testing of lifting sets

IMO/MSC Circular 860

Application :

Shackles for Lifting Sets for Offshore Containers and Portable Offshore Units

Issued at **Høvik** on **2019-07-24**

This Certificate is valid until **2024-06-29**.

DNV GL local station: **Kaohsiung**

Approval Engineer: **Nina Thorvaldsen Moberg**



for **DNV GL**
Digitally Signed By: Hals,
Inger-Helene
Signing Date: 13.08.2019
Location: Høvik, Norway

Inger-Helene Hals
Head of Section

Stu

This Certificate is subject to terms and conditions overleaf. Any significant change in design or construction may render this Certificate invalid. The validity date relates to the Type Approval Certificate and not to the approval of equipment/systems installed.



Form code: TA 251

Revision: 2016-12

www.dnvgl.com

Page 1 of 4

© DNV GL 2014. DNV GL and the Horizon Graphic are trademarks of DNV GL AS.



TYPE APPROVAL CERTIFICATE

Certificate No:
TAS000015G
 Revision No:
1

This is to certify:

That the **Lifting set component for offshore containers and portable offshore units**

with type designation(s)
Couplings - Type: Omega Link DA-018

Issued to
Yoke Industrial Corp.
Taichung, Taiwan

is found to comply with
DNV GL standard DNVGL-ST-E271 – 2.7-1 Offshore containers, January 2021
DNV GL standard DNVGL-ST-E273 – 2.7-3 Portable offshore units, April 2016 (Amended January 2020)
ISO 10855-2:2018 Offshore containers and associated liftings sets – Part 2: Design, manufacture and testing of lifting sets
IMO/MSC Circular 860
EN 1677-1 Components for slings – Safety – Part 1: Forged steel components, Grade 8

Application :

Grade 8, Couplings for offshore container and portable offshore units lifting sets

Issued at **Aberdeen** on **2021-12-03**

This Certificate is valid until **2026-12-02**.

DNV local unit: **Kaohsiung**

Approval Engineer: **Elisabeth Legg**

for DNV



Digitally signed by Kuppili, Satya
 Location: DNV Aberdeen, UK
 Contact info: DNV UK Limited
 Date: 2021.12.03 14:38:11Z001007

Satya Shyamala Kuppili
Team Lead - Containers

This Certificate is subject to terms and conditions overleaf. Any significant change in design or construction may render this Certificate invalid. The validity date relates to the Type Approval Certificate and not to the approval of equipment/systems installed.

LEGAL DISCLAIMER: Unless otherwise stated in the applicable contract with the holder of this document, or following from mandatory law, the liability of DNV AS, its parent companies and their subsidiaries as well as their officers, directors and employees ("DNV") arising from or in connection with the services rendered for the purpose of the issuance of this document or reliance thereon, whether in contract or in tort (including negligence), shall be limited to direct losses and under any circumstance be limited to 300,000 USD.



Form code: IA 281

Revision: 2021-10

www.dnv.com

Page 1 of 4



TYPE APPROVAL CERTIFICATE

Certificate No:
TAS00000T4
Revision No:
1

This is to certify:

That the Chain, shackles, swivels, sockets

with type designation(s)
Lifting points DA-271 for offshore cranes

Issued to
Yoke Industrial Corp.
Taichung City, Taiwan

is found to comply with
DNV standard DNV-ST-0378 – Offshore and platform lifting appliances

Application :

Product(s) approved by this certificate is/are accepted for installation on all vessels classed by DNV

Issued at **Høvik** on **2023-08-21**

This Certificate is valid until **2028-08-20**.

DNV local unit: **Kaohsiung**

Approval Engineer: **Ola Emil Ruud**

for **DNV**



Digitally Signed by: **Matteucci, Aldo**
Location: **DNV Høvik, Norway**
Signing Date: **22.08.2023**
on behalf of

Per Esvall
Head of Section

This Certificate is subject to terms and conditions overleaf. Any significant change in design or construction may render this Certificate invalid. The validity date relates to the Type Approval Certificate and not to the approval of equipment/systems installed.

LEGAL DISCLAIMER: Unless otherwise stated in the applicable contract with the holder of this document, or following from mandatory law, the liability of DNV AS, its parent companies and their subsidiaries as well as their officers, directors and employees ("DNV") arising from or in connection with the services rendered for the purpose of the issuance of this document or reliance thereon, whether in contract or in tort (including negligence), shall be limited to direct losses and under any circumstance be limited to 300,000 USD.



Form code: **TA 251**

Revision: **2022-12**

www.dnv.com

Page 1 of 4



TYPE APPROVAL CERTIFICATE

Certificate No:
TAS000011K
Revision No:
2

This is to certify:

That the **Hook**

with type designation(s)
Hooks DA-025 & DA-027N

Issued to
Yoke Industrial Corp.
Taichung City, Taiwan

is found to comply with
DNV standard DNV-ST-0378 – Offshore and platform lifting appliances

Application :

Product(s) approved by this certificate is/are accepted for installation on all vessels classed by DNV

Issued at **Høvik** on **2023-08-21**

This Certificate is valid until **2028-08-20**.

DNV local unit: **Kaohsiung**

Approval Engineer: **Ola Emil Ruud**

for **DNV**



Digitally Signed By: **Matteucci Aldo**
Location: **DNV Høvik, Norway**
Signing Date: **22.08.2023**
on behalf of

Per Esvall
Head of Section

This Certificate is subject to terms and conditions overleaf. Any significant change in design or construction may render this Certificate invalid. The validity date relates to the Type Approval Certificate and not to the approval of equipment/systems installed.

LEGAL DISCLAIMER: Unless otherwise stated in the applicable contract with the holder of this document, or following from mandatory law, the liability of DNV AS, its parent companies and their subsidiaries as well as their officers, directors and employees ("DNV") arising from or in connection with the services rendered for the purpose of the issuance of this document or reliance thereon, whether in contract or in tort (including negligence), shall be limited to direct losses and under any circumstance be limited to 300,000 USD.



Form code: **TA 251**

Revision: **2022-12**

www.dnv.com

Page 1 of 3

Safety is our first priority™
- Quality, Reliability, Innovation -

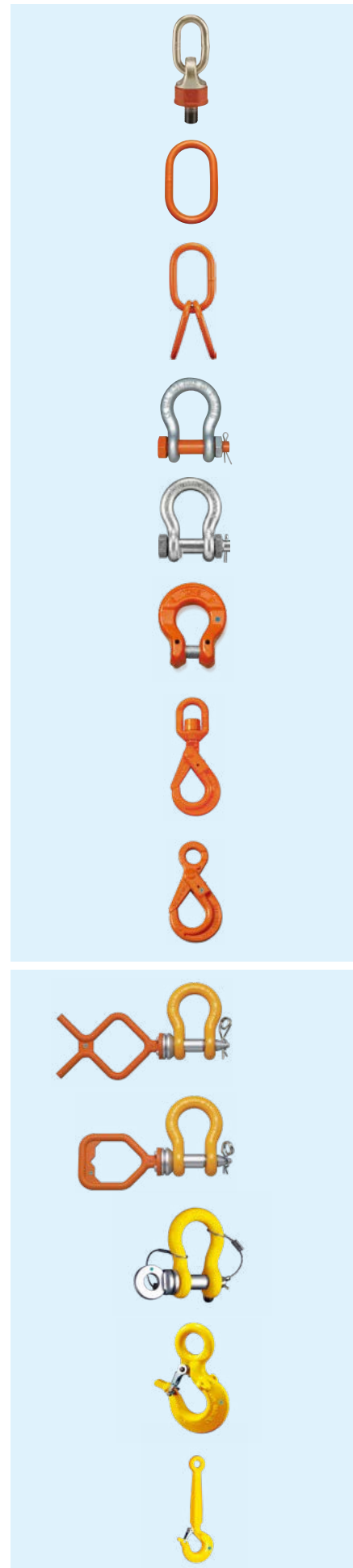

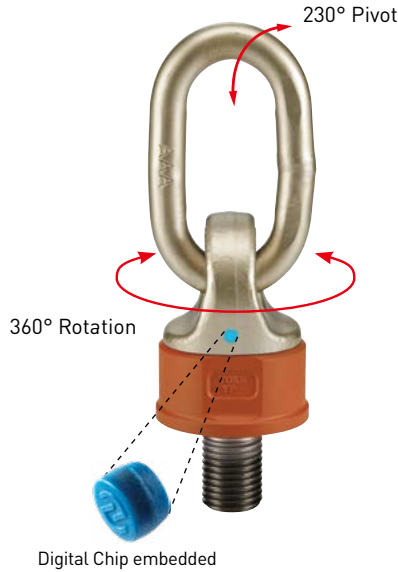
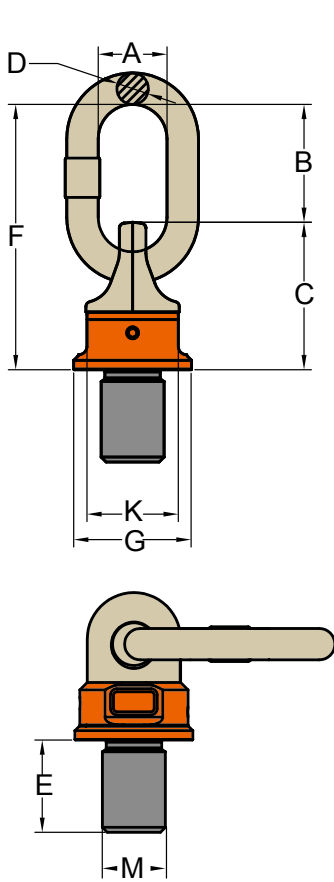

- Pivots to 230°, rotates through 360° due to its unique ball bearing design.
- Manufactured from forged alloy steel, quenched and tempered.
- Tested in accordance with DNV GL–ST-0378.
- Certified by DNV GL–ST-0378.
- Load rated parts are 100% magnaflux crack detected.
- Individual forged parts and batch code links to Test Certificate sheet.
- Bolts are Metric thread.
- Proof tested to 2.5 times the WLL.
- Fatigue rated to 20,000 cycles at 1.5 times the WLL.
- All YOKE Lifting points meet or exceed all the requirements of ASME B30.26.
- Easy to attach or dismantle due to the forged hexagon shaped body of the DA Swivel Point.
- Capable of rotating under load. Do not turn continuously in 90 degree direction at full load.

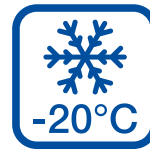

DA Swivel Point
Metric Thread (DA-271)

DNV GL-ST-0378
(Offshore and Platform Lifting Appliance)



Item No.	Working Load Limit	Thread version			Dimensions (mm)								Torque in Nm	N.W. kg
		M	E	Pitch	G	C	K	H	F	D	B	A		
	tonnes	mm	mm	DIN13	mm									
DA-271-003	0.4	M 8	12	1.25	35	40	30	16	72	8	32	29	10	0.2
DA-271-004	0.6	M 10	15	1.50	35	40	30	16	72	8	32	29	10	0.2
DA-271-006	0.7	M 12	18	1.75	40	45	36	18	95	10	50	35	10	0.3
DA-271-013	1.5	M 16	24	2.00	46	54	41	22	104	13	50	36	30	0.5
DA-271-020	2.5	M 20	30	2.50	62	68	55	29	122	13	54	36	70	1.0
DA-271-035	4.0	M 24	36	3.00	78	88	70	36	154	19	66	41	150	2.2
DA-271-060	6.0	M 30	45	3.50	90	120	80	48	206	22	86	50	350	4.5
DA-271-080	10.0	M 36	54	4.00	90	120	80	48	206	22	86	50	410	4.6
DA-271-120	13.0	M 42	63	4.50	98	122	84	50	235	25	110	67	550	5.5
DA-271-130	14.0	M 48	72	5.00	98	122	84	50	235	25	110	67	550	6.1
DA-271-140	20.0	M 52	78	5.00	120	150	94	60	270	32	120	72	750	10.5
DA-271-160	20.0	M 56	84	5.50	120	150	94	60	270	32	120	72	800	10.7
DA-271-161	20.0	M 64	96	6.00	120	150	94	60	270	32	120	72	800	11.6

*Design factor 4:1 proof tested and certified.



Kind of attachment																
	Number of legs	Load direction	1	2	1	2	2	2	2	3-4	3-4	3-4	3-4	3-4	3-4	
Item No.	Thread	WLL(t)														
DA-271-003	M 8	0.6	1.2	0.4	0.8	0.56	0.4	0.4	0.84	0.60	0.4					
DA-271-004	M10	0.9	1.8	0.6	1.2	0.84	0.6	0.6	1.26	0.90	0.6					
DA-271-006	M12	1.2	2.4	0.7	1.4	0.98	0.7	0.7	1.47	1.05	0.7					
DA-271-013	M16	2.6	5.2	1.5	3.0	2.10	1.5	1.5	3.15	2.25	1.5					
DA-271-020	M20	4.0	8.0	2.5	5.0	3.50	2.5	2.5	5.25	3.75	2.5					
DA-271-035	M24	7.0	14.0	4.0	8.0	5.60	4.0	4.0	8.40	6.00	4.0					
DA-271-060	M30	10.0	20.0	6.0	12.0	8.40	6.0	6.0	12.60	9.00	6.0					
DA-271-080	M36	15.0	30.0	10.0	20.0	14.00	10.0	10.0	21.00	15.00	10.0					
DA-271-120	M42	17.0	34.0	13.0	26.0	18.20	13.0	13.0	27.30	19.50	13.0					
DA-271-130	M48	18.0	36.0	14.0	28.0	19.60	14.0	14.0	29.40	21.00	14.0					
DA-271-140	M52	25.0	50.0	20.0	40.0	28.00	20.0	20.0	42.00	30.00	20.0					
DA-271-160	M56	28.0	56.0	20.0	40.0	28.00	20.0	20.0	42.00	30.00	20.0					
DA-271-161	M64	28.0	56.0	20.0	40.0	28.00	20.0	20.0	42.00	30.00	20.0					

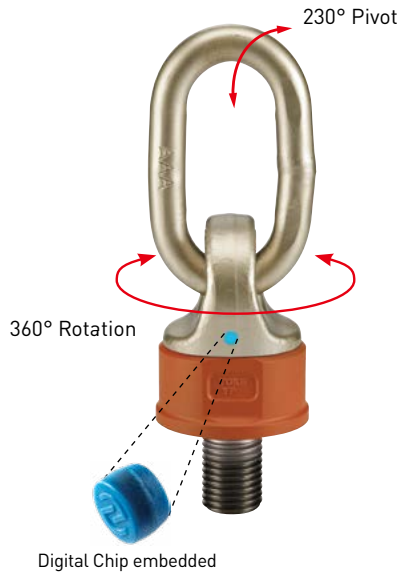
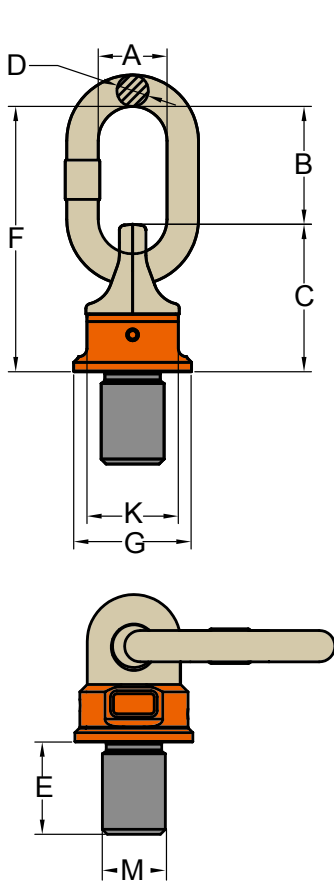

- Pivots to 230°, rotates through 360° due to its unique ball bearing design.
- Manufactured from forged alloy steel, quenched and tempered.
- Tested in accordance with DNV GL-ST-0378.
- Load rated parts are 100% magnaflux crack detected.
- Individual forged parts and batch code links to Test Certificate sheet.
- Bolts are UNC thread.
- Proof tested to 2.5 times the WLL.
- Fatigue rated to 20,000 cycles at 1.5 times the WLL.
- All YOKE Lifting points meet or exceed all the requirements of ASME B30.26.
- Easy to attach or dismantle due to the forged hexagon shaped body of the DA Swivel Point.
- Capable of rotating under load. Do not turn continuously in 90 degree direction at full load.



DA Swivel Point

UNC Thread (DA-272)

Item No.	Working Load Limit	Thread version			Dimensions (inch)								Torque in Nm	N.W. lbs
		M	E	TPI	G	C	K	H	F	D	B	A		
		inch	inch		inch	inch	inch	inch	inch	inch	inch	inch		
DA-272-006	0.7	1/2	0.75	13UNC	1.57	1.77	1.42	0.71	3.74	0.39	1.97	1.38	15	0.7
DA-272-013	1.5	5/8	0.94	11UNC	1.81	2.13	1.61	0.87	4.09	0.51	1.97	1.42	45	1.2
DA-272-018	2.0	3/4	1.13	10UNC	1.81	2.68	1.61	0.87	4.09	0.51	1.97	1.42	45	1.2
DA-272-020	2.5	7/8	1.31	9UNC	2.44	2.68	2.17	1.14	4.80	0.51	2.13	1.42	100	2.2
DA-272-035	4.0	1	1.50	8UNC	3.07	3.46	2.76	1.42	6.06	0.75	2.60	1.61	190	4.8
DA-272-060	6.0	1 1/4	1.88	7UNC	3.54	4.72	3.15	1.89	8.11	0.87	3.39	1.97	270	9.9
DA-272-080	10.0	1 1/2	2.25	6UNC	3.54	4.72	3.15	1.89	8.11	0.87	3.39	1.97	270	10.0
DA-272-120	13.0	1 3/4	2.63	5UNC	3.86	4.80	3.31	1.97	9.25	0.98	4.33	2.64	350	12.1
DA-272-130	14.0	2	3.00	4.5UNC	3.86	4.80	3.31	1.97	9.25	0.98	4.33	2.64	350	13.5
DA-272-140	20.0	2 1/4	3.38	4.5UNC	4.72	5.91	3.70	2.36	10.63	1.26	4.72	2.85	350	23.1
DA-272-160	20.0	2 1/2	3.75	4UNC	4.72	5.91	3.70	2.36	10.63	1.26	4.72	2.85	350	23.5

*Design factor 4:1 proof tested and certified.

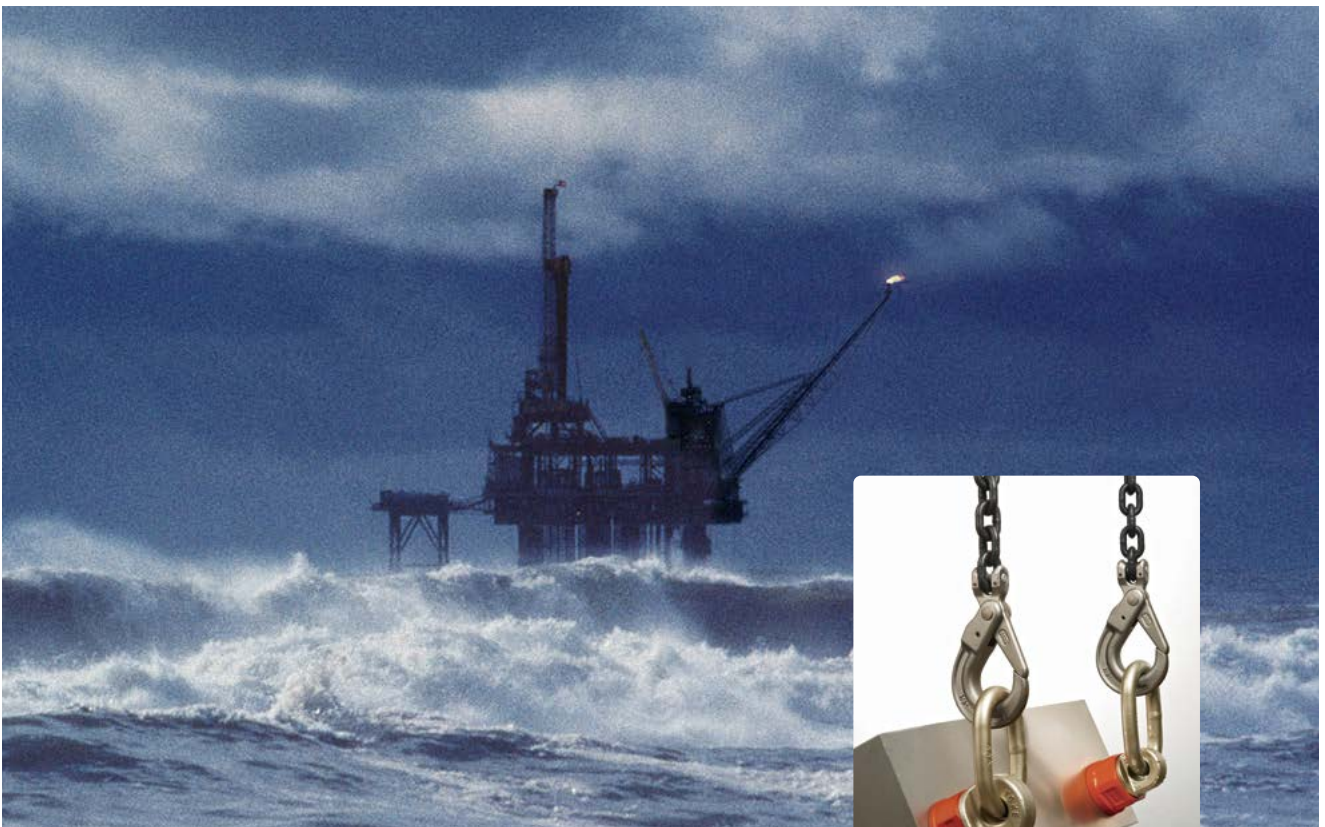

Kind of attachment																
	Number of legs	Thread	1	2	1	2	2	2	2	3-4	3-4	3-4	3-4	3-4	3-4	
Load direction			0°	0°	90°	90°	0-45°	45°- 60°	unsymm.	0 - 45°	45°- 60°	unsymm.	0 - 45°	45°- 60°	unsymm.	
Item No.	Thread	WLL(t)														
DA-272-006	1/2	1.2	2.4	0.7	1.4	0.98	0.7	0.7	1.47	1.05	0.7					
DA-272-013	5/8	2.6	5.2	1.5	3.0	2.10	1.5	1.5	3.15	2.25	1.5					
DA-272-018	3/4	3.6	7.2	2.0	4.0	2.80	2.0	2.0	4.20	3.00	2.0					
DA-272-020	7/8	4.0	8.0	2.5	5.0	3.50	2.5	2.5	5.25	3.75	2.5					
DA-272-035	1	7.0	14.0	4.0	8.0	5.60	4.0	4.0	8.40	6.00	4.0					
DA-272-060	1 1/4	10.0	20.0	6.0	12.0	8.40	6.0	6.0	12.60	9.00	6.0					
DA-272-080	1 1/2	15.0	30.0	10.0	20.0	14.00	10.0	10.0	21.00	15.00	10.0					
DA-272-120	1 3/4	17.0	34.0	13.0	26.0	18.20	13.0	13.0	27.30	19.50	13.0					
DA-272-130	2	18.0	36.0	14.0	28.0	19.60	14.0	14.0	29.40	21.00	14.0					
DA-272-140	2 1/4	25.0	50.0	20.0	40.0	28.00	20.0	20.0	42.00	30.00	20.0					
DA-272-160	2 1/2	28.0	56.0	20.0	40.0	28.00	20.0	20.0	42.00	30.00	20.0					

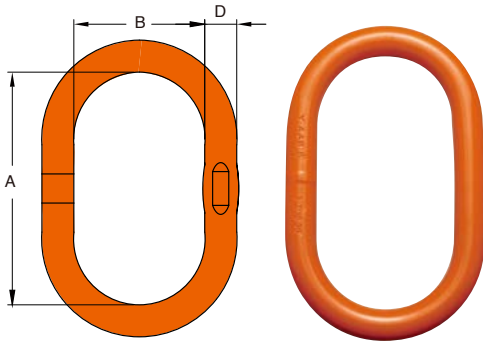

- Welded alloy steel, quenched and tempered.
- Tested and manufactured in accordance with DNV GL ST-2.7-1, EN 1677-4, ASME B30.26.
- Certified by DNV GL ST-2.7-1.
- Fatigue rated to 20,000 cycles at 1.5 times the Working Load Limit (WLL).
- Charpy tested in accordance with DNV GL ST-2.7-1.
- Proof Load tested to 2.5 times the Working Load Limit (WLL).
- Design factor 5:1.
- Charpy test of 42 joules (31ft. lbs.) at -40°C (-40°F) for normal section.
- Charpy test of 27 joules (20ft. lbs.) at -40°C (-40°F) for welded section.

DA Master Link

**DNV GL ST-2.7-1
(Offshore Containers)**



"can be used to single hook according to DIN 15401 NO."

Item No.	Code NO.	WLL	Proof	"can be used to single hook according to DIN 15401 NO."	Dimensions (inch)			N.W.
		β 0-45° tonnes	Load kN		D	A	B	lbs
DA-001-13	FD-13	2.8	69	2.5	0.51	4.72	2.36	0.8
DA-001-16	FD-16	4.0	98	6.0	0.63	6.30	3.54	1.6
DA-001-19	FD-19	6.7	164	6.0	0.75	6.30	3.54	2.4
DA-001-22	FD-22	8.9	218	8.0	0.87	7.09	3.94	3.6
DA-001-223	FD-223	6.3	154	16.0	0.87	10.63	5.51	5.0
DA-001-25	FD-25	11.5	282	10.0	0.98	8.27	4.53	5.3
DA-001-251	FD-251	11.5	282	16.0	0.98	10.83	5.71	6.7
DA-001-28	FD-28	13.0	319	16.0	1.10	10.83	5.71	8.5
DA-001-32	FD-32	17.1	419	16.0	1.26	10.83	5.71	11.3
DA-001-36	FD-36	24.0	588	20.0	1.42	11.22	6.10	15.1
DA-001-40	FD-40	28.1	688	20.0	1.57	11.81	6.30	19.7
DA-001-45	FD-45	38.3	938	25.0	1.77	13.39	7.09	28.2
DA-001-50	FD-50	45.0	1103	32.0	1.97	13.78	7.68	36.6

*Welded Master Link *Design Factor 5:1 *Proof tested at 2.5 times the WLL

"can be used to single hook according to DIN 15401 NO."

Item No.	Code NO.	WLL	Proof	"can be used to single hook according to DIN 15401 NO."	Dimensions (mm)			N.W.
		β 0-45° tonnes	Load kN		D	A	B	kg
DA-001-13	FD-13	2.8	69	2.5	13	120	60	0.4
DA-001-16	FD-16	4.0	98	6.0	16	160	90	0.7
DA-001-19	FD-19	6.7	164	6.0	19	160	90	1.1
DA-001-22	FD-22	8.9	218	8.0	22	180	100	1.6
DA-001-223	FD-223	6.3	154	16.0	22	270	140	2.3
DA-001-25	FD-25	11.5	282	10.0	25	210	115	2.4
DA-001-251	FD-251	11.5	282	16.0	25	275	145	3.1
DA-001-28	FD-28	13.0	319	16.0	28	275	145	3.9
DA-001-32	FD-32	17.1	419	16.0	32	275	145	5.1
DA-001-36	FD-36	24.0	588	20.0	36	285	155	6.9
DA-001-40	FD-40	28.1	688	20.0	40	300	160	8.9
DA-001-45	FD-45	38.3	938	25.0	45	340	180	12.8
DA-001-50	FD-50	45.0	1103	32.0	50	350	195	16.6

Sub-links SPEC for DA-007. Items in grey area are not for sale individually.

DA-001-131	FD-131	2.8	69	1.6	13	90	50	0.3
DA-001-161	FD-161	4.0	98	4.0	16	140	70	0.6
DA-001-191	FD-191	6.7	164	4.0	19	140	70	0.9
DA-001-221	FD-221	8.9	218	6.0	22	140	70	1.3
DA-001-222	FD-222	8.9	218	6.0	22	162	90	1.5
DA-001-281	FD-281	13.0	319	8.0	28	190	100	2.8
DA-001-282	FD-282	14.5	355	10.0	28	200	110	3.0
DA-001-361	FD-361	24.0	588	16.0	36	275	145	6.6
DA-001-401	FD-401	28.1	688	12.0	40	260	130	7.8



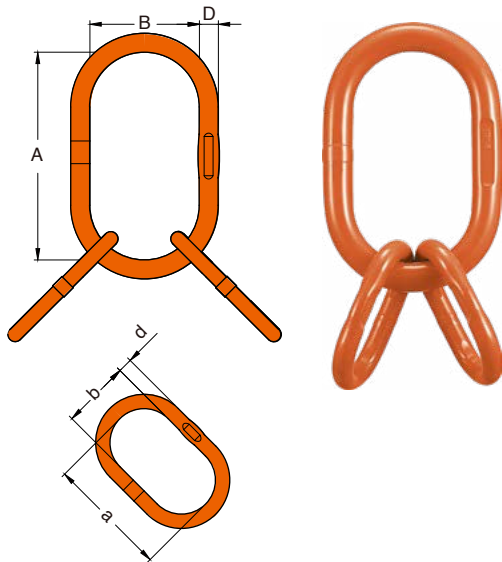

- Welded alloy steel, quenched and tempered.
- Tested and manufactured in accordance with DNV GL ST-2.7-1, EN 1677-4, ASME B30.26.
- Certified by DNV GL ST-2.7-1.
- Fatigue rated to 20,000 cycles at 1.5 times the Working Load Limit (WLL).
- Charpy tested in accordance with DNV GL ST-2.7-1.
- Proof Load tested to 2.5 times the Working Load Limit (WLL).
- Design factor 5:1.
- Charpy test of 42 joules (31ft. lbs.) at -40°C (-40°F) for normal section.
- Charpy test of 27 joules (20ft. lbs.) at -40°C (-40°F) for welded section.

DA Master Link Assembly

**DNV GL ST-2.7-1
(Offshore Containers)**

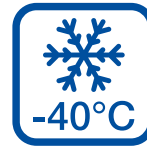

Item No.	Assembled with.	WLL β 0-45° tonnes	Proof Load kN	"can be used to single hook according to DIN 15401 NO."	Dimensions (inch)						N.W. lbs
					D	A	B	d	a	b	
DA-007-16	FD-161 +2 FD-131	4.1	100	4	0.63	5.51	2.76	0.51	3.54	1.97	2.7
DA-007-22	FD-222 +2 FD-191	8.9	218	6	0.87	6.38	3.54	0.75	5.51	2.76	7.4
DA-007-221	FD-223 +2 FD-161	6.3	154	16	0.87	10.63	5.51	0.63	5.51	2.76	7.9
DA-007-25	FD-251 +2 FD-19	8.9	218	16	0.98	10.83	5.71	0.75	6.30	3.54	11.5
DA-007-28	FD-28 +2 FD-22	12.9	316	16	1.10	10.83	5.71	0.87	7.09	3.94	15.7
DA-007-281	FD-282 +2 FD-221	14.5	355	10	1.10	7.87	4.33	0.87	5.51	2.76	12.2
DA-007-32	FD-32 +2 FD-25	17.0	417	16	1.26	10.83	5.71	0.98	8.27	4.53	22.0
DA-007-36	FD-361 +2 FD-281	23.6	578	16	1.42	10.83	5.71	1.10	7.48	3.94	26.9
DA-007-40	FD-40 +2 FD-32	28.1	688	20	1.57	11.81	6.30	1.26	10.83	5.71	42.4
DA-007-45	FD-45 +2 FD-36	38.3	938	25	1.77	13.39	7.09	1.42	11.22	6.10	58.4
DA-007-50	FD-50 +2 FD-401	45.0	1103	32	1.97	13.78	7.68	1.57	10.24	5.12	71.1

*Welded Master Link

*Design Factor 5:1

*Proof tested at 2.5 times the WLL

Item No.	Assembled with.	WLL β 0-45° tonnes	Proof Load kN	"can be used to single hook according to DIN 15401 NO."	Dimensions (mm)						N.W. kg
					D	A	B	d	a	b	
DA-007-16	FD-161 +2 FD131	4.1	100	4	16	140	70	13	90	50	1.2
DA-007-22	FD-222 +2 FD191	8.9	218	6	22	162	90	19	140	70	3.3
DA-007-221	FD-223 +2 FD161	6.3	154	16	22	270	140	16	140	70	3.6
DA-007-25	FD-251 +2 FD-19	8.9	218	16	25	275	145	19	160	90	5.2
DA-007-28	FD-28 +2 FD-22	12.9	316	16	28	275	145	22	180	100	7.1
DA-007-281	FD-282 +2 FD-221	14.5	355	10	28	200	110	22	140	70	5.5
DA-007-32	FD-32 +2 FD-25	17.0	417	16	32	275	145	25	210	115	10.0
DA-007-36	FD-361 +2 FD-281	23.6	578	16	36	275	145	28	190	100	12.2
DA-007-40	FD-40 +2 FD-32	28.1	688	20	40	300	160	32	275	145	19.2
DA-007-45	FD-45 +2 FD-36	38.3	938	25	45	340	180	36	285	155	26.5
DA-007-50	FD-50 +2 FD-401	45.0	1103	32	50	350	195	40	260	130	32.3

*Welded Master Link

*Design Factor 5:1

*Proof tested at 2.5 times the WLL

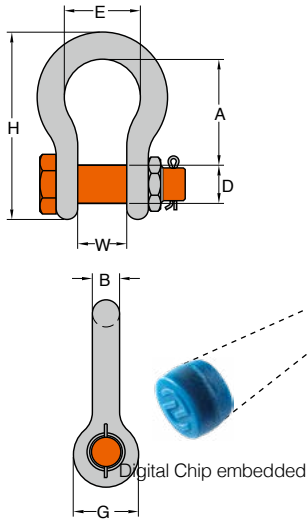

- Forged alloy steel, quenched and tempered.
- Tested and manufactured in accordance with DNV GL ST-2.7-1, DNV GL-ST-0378, EN 13889, ASME B30.26, U.S. Fed. Spec. RR-C-271F Type IVA, Grade A, Class 3.
- Certified by DNV GL ST-2.7-1.
- Fatigue rated to 20,000 cycles at 1.5 times the Working Load Limit (WLL).
- Charpy tested in accordance with DNV GL ST-2.7-1.
- Hot dip galvanized.
- Charpy test of 42 joules (31ft. lbs.) at -40°C (-40°F) for normal section.

DA 838 Shackle

Grade 6

**DNV GL ST-2.7-1
(Offshore Containers)**

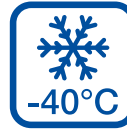

Item No.	Nominal Size	Working Load Limit	Dimensions (inch)							N.W.
	inch		tonnes*	A	B	D	E	G	H	
DA-838-13	1/2	2.00	1.93	0.52	0.63	1.30	1.18	3.34	0.79	0.9
DA-838-16	5/8	3.25	2.40	0.63	0.75	1.70	1.50	4.17	1.06	1.5
DA-838-19	3/4	4.75	2.83	0.75	0.87	1.97	1.81	5.04	1.30	2.2
DA-838-22	7/8	6.50	3.39	0.87	0.98	2.28	2.09	5.91	1.50	3.7
DA-838-26	1	8.50	3.78	1.02	1.10	2.68	2.40	6.57	1.73	5.3
DA-838-28	1- 1/8	9.50	4.37	1.10	1.26	2.91	2.68	7.52	1.81	7.5
DA-838-32	1- 1/4	12.00	4.84	1.26	1.42	3.30	2.99	8.07	2.12	10.6
DA-838-36	1- 3/8	13.50	5.28	1.42	1.50	3.62	3.31	9.13	2.32	14.3
DA-838-38	1- 1/2	17.00	5.57	1.50	1.69	3.90	3.62	10.00	2.36	19.4
DA-838-45	1- 3/4	25.00	7.00	1.85	2.00	5.00	4.17	12.32	2.87	38.5
DA-838-50	2	35.00	7.76	2.09	2.24	5.75	4.80	13.66	3.27	53.2
DA-838-64	2- 1/2	** 55.00	10.51	2.62	2.76	7.24	5.91	17.95	4.13	95.7
DA-838-76	3	** 85.00	12.99	3.11	3.25	7.87	6.61	21.57	5.00	178.2
DA-838-89	3- 1/2	**120.00	14.65	3.62	3.76	9.02	7.99	24.65	5.24	264.0
DA-838-100	4	**150.00	14.49	4.09	4.25	10.00	9.02	25.71	5.51	336.6

*2t to 35t are type approved of DNV 2.7-1. Minimum Ultimate Load is 6 times the Working Load Limit.

**55t to 150t meet all requirements of DNV 2.7-1. Minimum Ultimate Load is 6 times the Working Load Limit.

Item No.	Nominal Size	Working Load Limit	Dimensions (mm)							N.W.
	mm		tonnes*	A	B	D	E	G	H	
DA-838-13	13	2.00	49	13.0	16	33	30	85	20	0.4
DA-838-16	16	3.25	61	16.0	19	43	38	106	27	0.7
DA-838-19	19	4.75	72	19.0	22	50	46	126	33	1.0
DA-838-22	22	6.50	86	22.0	25	58	53	148	38	1.7
DA-838-26	26	8.50	96	26.0	28	68	61	166	44	2.4
DA-838-28	28	9.50	111	28.0	32	74	68	190	46	3.4
DA-838-32	32	12.00	123	32.0	36	84	76	210	54	4.8
DA-838-36	36	13.50	134	36.0	38	92	84	232	59	6.5
DA-838-38	38	17.00	146	38.0	43	99	92	254	60	8.8
DA-838-45	45	25.00	178	47.0	51	127	106	313	73	17.5
DA-838-50	50	35.00	197	53.0	57	146	122	347	83	24.2
DA-838-64	64	** 55.00	267	66.5	70	184	150	456	105	43.5
DA-838-76	76	** 85.00	330	79.0	82.5	200	168	548	127	81.0
DA-838-89	89	**120.00	372	92.0	95.5	229	203	626	133	120.0
DA-838-100	100	**150.00	368	104.0	108	254	229	653	140	153.0

*2t to 35t are type approved of DNV 2.7-1. Minimum Ultimate Load is 6 times the Working Load Limit.

**55t to 150t meet all requirements of DNV 2.7-1. Minimum Ultimate Load is 6 times the Working Load Limit.



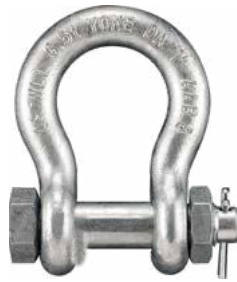
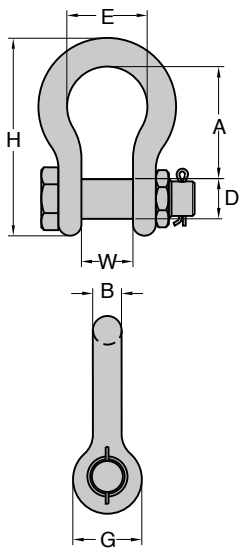

- Forged alloy steel, quenched and tempered.
- Tested and manufactured in accordance with DNV GL ST-2.7-1, DNV GL-ST-0378, EN 13889, ASME B30.26, U.S. Fed. Spec. RR-C-271F Type IVA, Grade A, Class 3.
- Certified by DNV GL ST-2.7-1.
- Fatigue rated to 20,000 cycles at 1.5 times the Working Load Limit (WLL).
- Charpy tested in accordance with DNV GL ST-2.7-1.
- Hot dip galvanized.
- Charpy test of 42 joules (31ft. lbs.) at -40°C (-40°F) for normal section.

DA 808 Shackle

Grade 8

DNV GL ST-2.7-1
(Offshore Containers)

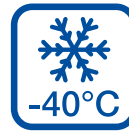

Item No.	Nominal Size	Working Load Limit tonnes*	Dimensions (inch)							N.W. lbs
	inch		A	B	D	E	G	H	W	
DA-808-13	1/2	2.00	1.93	0.52	0.63	1.30	1.18	3.34	0.79	0.9
DA-808-16	5/8	3.25	2.40	0.63	0.75	1.70	1.50	4.17	1.06	1.5
DA-808-19	3/4	4.75	2.83	0.75	0.87	1.97	1.81	5.04	1.30	2.2
DA-808-22	7/8	6.50	3.39	0.87	0.98	2.28	2.09	5.91	1.50	3.7
DA-808-26	1	8.50	3.78	1.02	1.10	2.68	2.40	6.57	1.73	5.3
DA-808-28	1- 1/8	9.50	4.37	1.10	1.26	2.91	2.68	7.52	1.81	7.5
DA-808-32	1- 1/4	12.00	4.84	1.26	1.42	3.30	2.99	8.07	2.12	10.6
DA-808-36	1- 3/8	13.50	5.28	1.42	1.50	3.62	3.31	9.13	2.32	14.3
DA-808-38	1- 1/2	17.00	5.57	1.50	1.69	3.90	3.62	10.00	2.36	19.4
DA-808-45	1- 3/4	25.00	7.00	1.85	2.00	5.00	4.17	12.32	2.87	38.5
DA-808-50	2	35.00	7.76	2.09	2.24	5.75	4.80	13.66	3.27	53.2
DA-808-64	2- 1/2	** 85.00	10.51	2.62	2.76	7.24	5.91	17.95	4.13	95.7
DA-808-76	3	**120.00	12.99	3.11	3.25	7.87	6.61	21.57	5.00	178.2
DA-808-89	3- 1/2	**150.00	14.65	3.62	3.76	9.02	7.99	24.65	5.24	264.0
DA-808-100	4	**175.00	14.49	4.09	4.25	10.00	9.02	25.71	5.51	336.6

*2t to 35t are type approved of DNV 2.7-1. Minimum Ultimate Load is 8 times the Working Load Limit.

**85t to 175t meet all requirements of DNV 2.7-1. Minimum Ultimate Load is 5.4 times the Working Load Limit.

Item No.	Nominal Size	Working Load Limit tonnes*	Dimensions (mm)							N.W. kg
	mm		A	B	D	E	G	H	W	
DA-808-13	13	2.00	49	13.0	16.0	33	30	85	20	0.4
DA-808-16	16	3.25	61	16.0	19.0	43	38	106	27	0.7
DA-808-19	19	4.75	72	19.0	22.0	50	46	126	33	1.0
DA-808-22	22	6.50	86	22.0	25.0	58	53	148	38	1.7
DA-808-26	26	8.50	96	26.0	28.0	68	61	166	44	2.4
DA-808-28	28	9.50	111	28.0	32.0	74	68	190	46	3.4
DA-808-32	32	12.00	123	32.0	36.0	84	76	210	54	4.8
DA-808-36	36	13.50	134	36.0	38.0	92	84	232	59	6.5
DA-808-38	38	17.00	146	38.0	43.0	99	92	254	60	8.8
DA-808-45	45	25.00	178	47.0	51.0	127	106	313	73	17.5
DA-808-50	50	35.00	197	53.0	57.0	146	122	347	83	24.2
DA-808-64	64	** 85.00	267	66.5	70.0	184	150	456	105	43.5
DA-808-76	76	**120.00	330	79.0	82.5	200	168	548	127	81.0
DA-808-89	89	**150.00	372	92.0	95.5	229	203	626	133	120.0
DA-808-100	100	**175.00	368	104.0	108.0	254	229	653	140	153.0

*2t to 35t are type approved of DNV 2.7-1. Minimum Ultimate Load is 8 times the Working Load Limit.

**85t to 175t meet all requirements of DNV 2.7-1. Minimum Ultimate Load is 5.4 times the Working Load Limit.

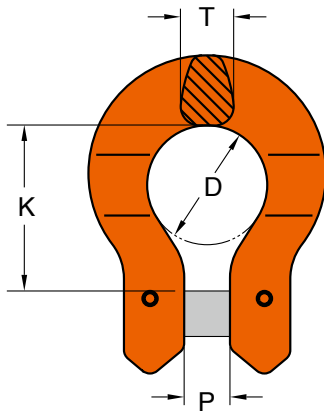

- Forged alloy steel, quenched and tempered.
- Tested and manufactured in accordance with EN 1677-1 ,DNVGL-ST-E271 and DNV GL-ST-E273.
- Certified by DNV GL-ST-E271 and DNV GL-ST-E273.
- Fatigue rated to 20,000 cycles at 1.5 times the Working Load Limit (WLL).
- Charpy tested in accordance with DNV GL-ST-E271.
- Design factor 4:1.
- Charpy test of 42 joules (31ft. lbs.) at -20°C (-4°F)

DA Omega Link

**DNV GL ST-2.7-1
(Offshore Containers)**

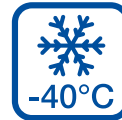

Item No.	Working Load Limit	For Grade 80 Chain	Dimensions (inch)				N.W.
	tonnes*		inch	D	K	P	
DA-018-06	1.12	7/32	0.83	1.15	0.26	0.35	0.2
DA-018-07	2	9/32,5/16	1.04	1.41	0.37	0.43	0.4
DA-018-10	3.15	3/8	1.26	1.73	0.46	0.57	0.9
DA-018-13	5.3	1/2	1.65	2.18	0.61	0.67	1.8
DA-018-16	8	5/8	1.97	2.73	0.71	0.87	3.5
DA-018-20	12.5	3/4	2.28	3.27	0.85	1.08	4.6

Item No.	Working Load Limit	For Grade 80 Chain	Dimensions (mm)				N.W.
	tonnes*		mm	D	K	P	
DA-018-06	1.12	6	21	29	7	9	0.1
DA-018-07	2	7,8	27	36	9	11	0.2
DA-018-10	3.15	10	32	44	12	15	0.4
DA-018-13	5.3	13	42	55	16	17	0.8
DA-018-16	8	16	50	69	18	22	1.6
DA-018-20	12.5	18,20	58	83	22	28	2.1

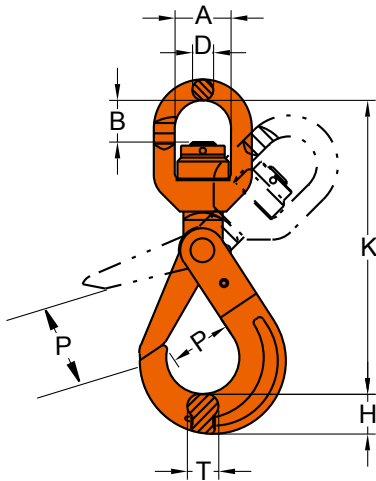

- Forged alloy steel, quenched and tempered.
- Tested and manufactured in accordance with EN 1677 and Norsok R002.
- Certified by DNV GL-ST-0378.
- Fatigue rated to 20,000 cycles at 1.5 times the Working Load Limit (WLL).
- Charpy tested in accordance with DNV GL-ST-0378.
- Designed with recessed trigger and ball bearing, providing the locking mechanism being protected against inadvertent opening due to entanglement with any obstruction during lifting.
- Design factor 4:1 and 5:1.
- Latch mechanism is self locking under loading.
- Charpy test of 42 joules (31ft. lbs.) at -20°C (-4°F).

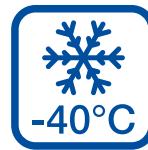

DA Swivel Self Locking Hook

DNV GL-ST-0378
(Offshore and Platform Lifting Appliance)



With Ball Bearing, which performs full swivel under load

Item No.	Working Load Limit		Dimensions (inch)							N.W. lbs
	tonnes		A	B	D	H	K	P	T	
	5:1	4:1								
DA-027N-13W	5.3	6.7	2.40	2.52	0.91	1.54	11.61	2.01	1.18	11
DA-027N-16W	8.0	10.0	2.91	3.66	0.98	1.93	14.53	2.36	1.42	18
DA-027N-20	12.8	16.0	2.91	3.23	0.98	2.56	15.24	2.76	2.09	29
DA-027N-22	15.2	19.0	3.82	3.74	1.30	2.48	17.99	3.15	1.93	44
DA-027N-26	21.2	26.5	4.84	4.53	1.65	2.72	21.06	3.90	2.20	72
DA-027N-32	25.2	31.5	4.84	4.53	1.65	3.19	22.95	4.72	2.48	90

Item No.	Working Load Limit		Dimensions (mm)							N.W. kg
	tonnes		A	B	D	H	K	P	T	
	5:1	4:1								
DA-027N-13W	5.3	6.7	61	64	23	39	295	51	30	5.0
DA-027N-16W	8.0	10.0	74	93	25	49	369	60	36	8.1
DA-027N-20	12.8	16.0	74	82	25	65	387	70	53	13.0
DA-027N-22	15.2	19.0	97	95	33	63	457	80	49	20.0
DA-027N-26	21.2	26.5	123	115	42	69	535	99	56	32.7
DA-027N-32	25.2	31.5	123	115	42	81	583	120	63	41.0

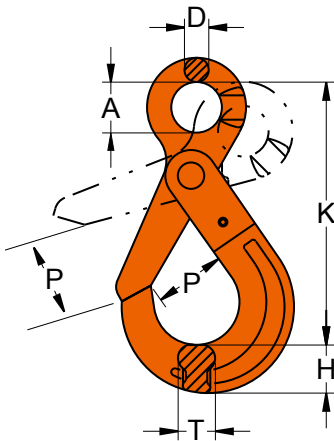

- Forged alloy steel, quenched and tempered.
- Tested and manufactured in accordance with EN 1677 and Norsok R002.
- Certified by DNV GL-ST-0378.
- Fatigue rated to 20,000 cycles at 1.5 times the Working Load Limit (WLL).
- Charpy tested in accordance with DNV GL-ST-0378.
- Designed with recessed trigger, providing the locking mechanism being protected against inadvertent opening due to entanglement with any obstruction during lifting.
- Design factor 4:1 and 5:1.
- Latch mechanism is self locking under loading.
- Charpy test of 42 joules (31ft. lbs.) at -20°C (-4°F).

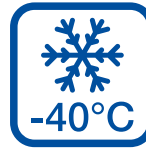

DA Eye Self Locking Hook

DNV GL-ST-0378
(Offshore and Platform Lifting Appliance)



Item No.	Working Load Limit		Dimensions (inch)					N.W. lbs	
	tonnes		A	D	H	K	P		T
	5:1	4:1							
DA-025-13	5.3	6.7	1.57	0.63	1.54	8.15	2.05	1.18	6.6
DA-025-16	8.0	10.0	1.97	0.83	1.93	9.92	2.36	1.42	12.8
DA-025-20	12.8	16.0	2.40	0.91	2.56	11.54	2.76	1.89	22.0
DA-025-22	15.2	19.0	2.76	0.94	2.48	12.56	3.15	1.93	27.5
DA-025-26	21.2	26.5	3.15	0.98	2.72	13.50	3.90	2.20	32.3
DA-025-32	25.2	31.5	3.54	1.10	3.19	15.79	4.72	2.48	57.3

Item No.	Working Load Limit		Dimensions (mm)					N.W. kg	
	tonnes		A	D	H	K	P		T
	5:1	4:1							
DA-025-13	5.3	6.7	40	16	39	207	52	30	3.0
DA-025-16	8.0	10.0	50	21	49	252	60	36	5.8
DA-025-20	12.8	16.0	61	23	65	293	70	48	10.0
DA-025-22	15.2	19.0	70	24	63	319	80	49	12.5
DA-025-26	21.2	26.5	80	25	69	343	99	56	14.7
DA-025-32	25.2	31.5	90	28	81	401	120	63	26.0

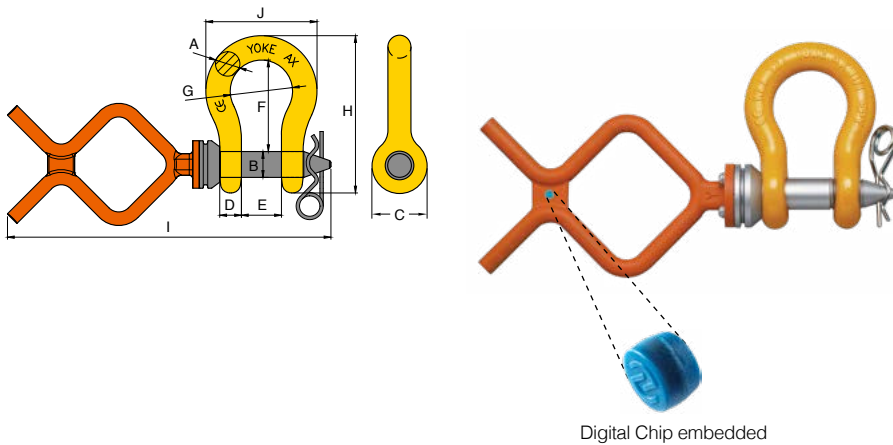

- Forged alloy steel, quenched and tempered.
- Designed specifically for ROV application.
- Handles are Carbon Steel.
- Individually stamped with the Working Load Limit.
- Shackle Bows are painted yellow to ensure ease of sight in water.
- Convertible handles on ROV shackle bolts.

ROV Anchor Shackle with Fishtail-handle and Safety Pin (ROV: Remotely Operated Vehicle)

Item No.	Nominal Size	Working Load Limit	Dimensions (inch)										N.W. lbs
			A	B	C	D	E	F	G	H	I	J	
8-941-22	7/8	6.5	0.9	1.0	2.1	0.8	1.5	3.4	2.3	5.8	16.5	4.0	9.3
8-941-26	1	8.5	1.0	1.1	2.4	0.9	1.7	3.8	2.7	6.5	16.9	4.7	10.6
8-941-28	1-1/8	9.5	1.1	1.3	2.7	1.1	1.8	4.4	2.9	7.5	17.9	5.1	12.5
8-941-32	1-1/4	12.0	1.3	1.4	3.0	1.2	2.1	4.8	3.3	8.3	18.4	5.8	15.8
8-941-36	1-3/8	13.5	1.4	1.5	3.3	1.3	2.3	5.3	3.6	9.1	18.8	6.5	18.9
8-941-38	1-1/2	17.0	1.5	1.8	3.6	1.4	2.4	5.7	3.9	10.0	19.3	6.9	23.5
8-941-45	1-3/4	25.0	1.9	2.0	4.2	1.7	2.9	7.0	5.0	12.3	21.1	8.7	38.7
8-941-50	2	35.0	2.1	2.2	4.8	2.0	3.3	7.8	5.7	13.7	22.0	9.8	58.1

* Minimum Ultimate Load is 5 times the Working Load Limit.
Maximum Proof Load is 2 times the Working Load Limit.

Item No.	Nominal Size	Working Load Limit	Dimensions (mm)										N.W. kg
			A	B	C	D	E	F	G	H	I	J	
8-941-22	22	6.5	22	26	53	21.5	38.0	86	58	148.0	420	102.0	4.2
8-941-26	26	8.5	26	28	61	23.0	44.0	96	68	166.0	429	120.0	4.8
8-941-28	28	9.5	28	32	68	27.0	46.0	111	74	190.0	454	130.0	5.7
8-941-32	32	12.0	32	36	76	29.5	54.0	121	84	210.0	467	148.0	7.2
8-941-36	36	13.5	36	38	84	32.0	59.0	134	92	232.0	477	164.0	8.6
8-941-38	38	17.0	38	45	92	35.0	60.5	146	99	254.0	489	175.0	10.7
8-941-45	45	25.0	47	50	106	44.0	73.0	178	127	313.0	536	221.0	17.6
8-941-50	50	35.0	53	57	122	50.8	83.5	197	146	347.5	560	247.7	26.4

* Minimum Ultimate Load is 5 times the Working Load Limit.
Maximum Proof Load is 2 times the Working Load Limit.

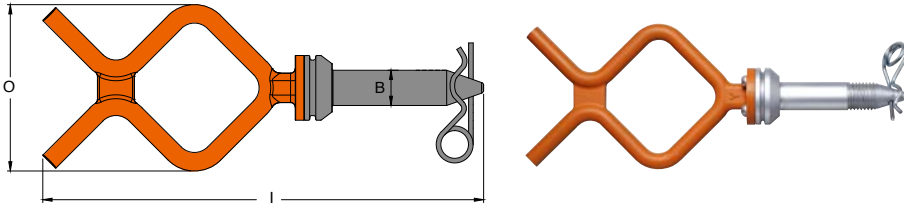

- Carbon Steel, quenched and tempered.
- Designed specifically for ROV application.
- Convertible handles on ROV shackle bolts.

ROV Anchor Shackle Fishtail-handle

Item No.	Working Load Limit tonnes	Dimensions (inch)			N.W. lbs
		B	L	O	
8-941FT-22	6.5	1.02	16.54	7.09	5.9
8-941FT-26	8.5	1.10	16.89	7.09	6.4
8-941FT-28	9.5	1.26	17.87	7.09	7.0
8-941FT-32	12.0	1.42	18.39	7.09	7.7
8-941FT-36	13.5	1.50	18.78	7.09	8.4
8-941FT-38	17.0	1.77	19.25	7.09	9.7
8-941FT-45	25.0	1.97	21.10	7.09	12.3
8-941FT-50	35.0	2.24	22.05	7.09	15.2

Item No.	Working Load Limit tonnes	Dimensions (mm)			N.W. kg
		B	L	O	
8-941FT-22	6.5	26	420	180	2.7
8-941FT-26	8.5	28	429	180	2.9
8-941FT-28	9.5	32	454	180	3.2
8-941FT-32	12.0	36	467	180	3.5
8-941FT-36	13.5	38	477	180	3.8
8-941FT-38	17.0	45	489	180	4.4
8-941FT-45	25.0	50	536	180	5.6
8-941FT-50	35.0	57	560	180	6.9

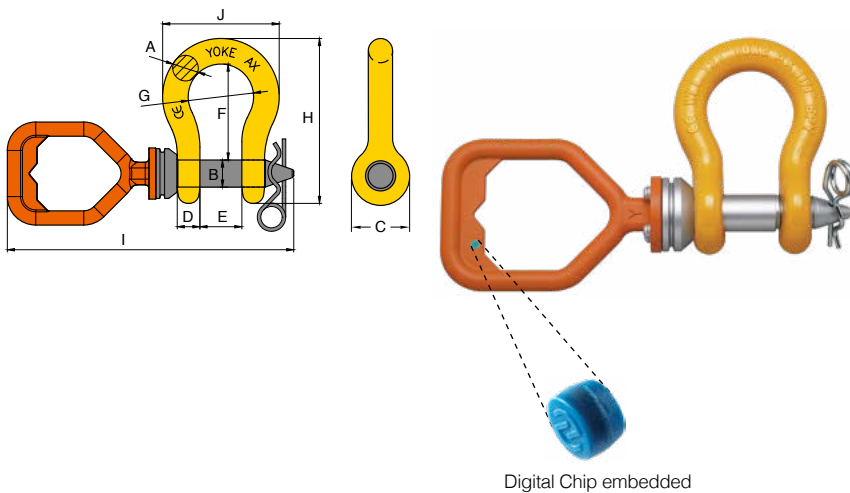

- Forged alloy steel, quenched and tempered.
- Designed specifically for ROV application.
- Handles are Carbon Steel.
- Individually stamped with the Working Load Limit.
- Shackle Bows are painted yellow to ensure ease of sight in water.
- Convertible handles on ROV shackle bolts.

Digital Chip embedded

ROV Anchor Shackle with D-handle and Safety Pin (ROV: Remotely Operated Vehicle)

Item No.	Nominal Size	Working Load Limit	Dimensions (inch)										N.W.
	inch		tonnes	A	B	C	D	E	G	H	I	J	lbs
8-951-22	7/8	6.5	0.9	1.0	2.1	0.9	1.5	2.3	5.8	13.6	4.0	9.9	
8-951-26	1	8.5	1.0	1.1	2.4	0.9	1.7	2.7	6.5	14.0	4.7	11.2	
8-951-28	1-1/8	9.5	1.1	1.3	2.7	1.1	1.8	2.9	7.5	15.0	5.1	13.2	
8-951-32	1-1/4	12.0	1.3	1.4	3.0	1.2	2.1	3.3	8.3	15.5	5.8	16.5	
8-951-36	1-3/8	13.5	1.4	1.5	3.3	1.3	2.3	3.6	9.1	15.9	6.5	19.6	
8-951-38	1-1/2	17.0	1.5	1.8	3.6	1.4	2.4	3.8	10.0	16.3	6.9	24.2	
8-951-45	1-3/4	25.0	1.8	2.0	4.2	1.7	2.9	5.0	12.3	18.2	8.7	39.4	
8-951-50	2	35.0	2.0	2.2	4.8	2.0	3.3	5.7	13.7	19.1	9.8	58.7	

* Minimum Ultimate Load is 5 times the Working Load Limit.
Maximum Proof Load is 2 times the Working Load Limit.

Item No.	Nominal Size	Working Load Limit	Dimensions (mm)										N.W.
	mm		tonnes	A	B	C	D	E	G	H	I	J	kg
8-951-22	22	6.5	22	26	53	21.5	38.0	58	148.0	346	102.0	4.5	
8-951-26	26	8.5	26	28	61	23.0	44.0	68	166.0	355	120.0	5.1	
8-951-28	28	9.5	28	32	68	27.0	46.0	74	190.0	380	130.0	6.0	
8-951-32	32	12.0	32	36	76	29.5	54.0	84	210.0	393	148.0	7.5	
8-951-36	36	13.5	36	38	84	32.0	59.0	92	232.0	403	164.0	8.9	
8-951-38	38	17.0	38	45	92	35.0	60.5	97	254.0	415	175.0	11.0	
8-951-45	45	25.0	45	50	106	44.0	73.0	127	313.0	462	221.0	17.9	
8-951-50	50	35.0	50	57	122	50.8	83.5	146	347.5	486	247.7	26.7	

* Minimum Ultimate Load is 5 times the Working Load Limit.
Maximum Proof Load is 2 times the Working Load Limit.

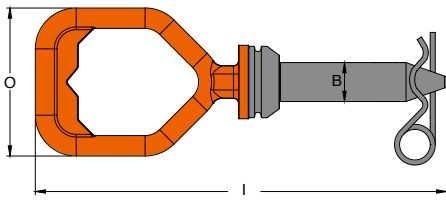

- Carbon Steel, quenched and tempered.
- Designed specifically for ROV application.
- Convertible handles on ROV shackle bolts.

ROV Anchor Shackle D-handle

Item No.	Working Load Limit tonnes	Dimensions (inch)			N.W. lbs
		B	I	O	
8-951DH-22	6.5	1.02	16.54	5.71	5.1
8-951DH-26	8.5	1.10	16.89	5.71	5.5
8-951DH-28	9.5	1.26	17.87	5.71	6.4
8-951DH-32	12.0	1.42	18.39	5.71	6.8
8-951DH-36	13.5	1.50	18.78	5.71	7.5
8-951DH-38	17.0	1.77	19.25	5.71	9.0
8-951DH-45	25.0	1.97	21.10	5.71	11.7
8-951DH-50	35.0	2.24	22.05	5.71	14.3

Item No.	Working Load Limit tonnes	Dimensions (mm)			N.W. kg
		B	I	O	
8-951DH-22	6.5	26	420	145	2.3
8-951DH-26	8.5	28	429	145	2.5
8-951DH-28	9.5	32	454	145	2.9
8-951DH-32	12.0	36	467	145	3.1
8-951DH-36	13.5	38	477	145	3.4
8-951DH-38	17.0	45	489	145	4.1
8-951DH-45	25.0	50	536	145	5.3
8-951DH-50	35.0	57	560	145	6.5

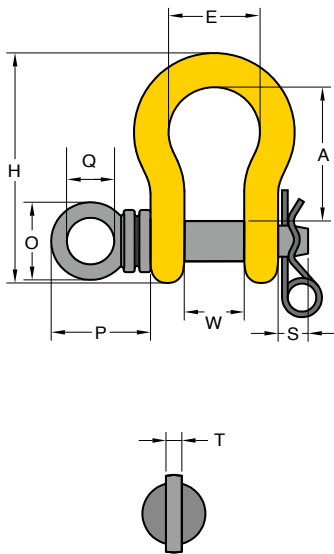

ROV: Remotely Operated Vehicle

- Forged alloy steel, quenched and tempered.
- Designed specifically for ROV application.
- Individually stamped with the Working Load Limit.
- Shackle Bows are painted yellow to ensure ease of sight in water.

ROV Anchor Shackle with Safety Pin (ROV: Remotely Operated Vehicle)

Item No.	Nominal Size		Working Load Limit tonnes*	Dimensions (inch)									N.W. lbs
	inch	mm		A	E	H	O	P	Q	S	T	W	
8-911-22	7/8	22	6.5	3.39	2.28	5.91	1.96	2.36	1.18	0.87	0.39	1.50	4.0
8-911-26	1	26	8.5	3.78	2.68	6.57	1.96	2.48	1.18	0.91	0.39	1.73	5.5
8-911-28	1 1/8	28	9.5	4.37	2.91	7.52	2.75	3.35	1.38	0.94	0.47	1.81	7.9
8-911-32	1 1/4	32	12.0	4.76	3.30	8.07	2.75	3.35	1.38	1.14	0.47	2.12	10.6
8-911-36	1 3/8	36	13.5	5.28	3.62	9.13	2.95	3.66	1.57	1.22	0.59	2.32	15.0
8-911-38	1 1/2	38	17.0	5.75	3.90	10.00	2.95	3.74	1.57	1.22	0.59	2.36	18.3
8-911-45	1 3/4	45	25.0	7.00	5.00	12.32	3.54	4.48	1.97	1.38	0.71	2.87	36.5
8-911-50	2	50	35.0	7.76	5.75	13.66	4.17	5.19	2.36	1.57	0.78	3.27	51.5

★ Minimum Ultimate Load is 5 times the Working Load Limit.
Maximum Proof Load is 2 times the Working Load Limit.

Item No.	Nominal Size		Working Load Limit tonnes*	Dimensions (mm)									N.W. kg
	inch	mm		A	E	H	O	P	Q	S	T	W	
8-911-22	7/8	22	6.5	86	58	148	50	60	30	22	10	38	1.8
8-911-26	1	26	8.5	96	69	166	50	63	30	23	10	44	2.5
8-911-28	1 1/8	28	9.5	111	74	190	70	85	35	24	12	46	3.6
8-911-32	1 1/4	32	12.0	121	84	210	70	85	35	29	12	54	4.8
8-911-36	1 3/8	36	13.5	134	92	232	75	93	40	31	15	59	6.8
8-911-38	1 1/2	38	17.0	146	99	254	75	95	40	31	15	60	8.3
8-911-45	1 3/4	45	25.0	178	127	313	90	114	50	35	18	73	16.6
8-911-50	2	50	35.0	197	146	347	106	132	60	40	20	83	23.4

★ Minimum Ultimate Load is 5 times the Working Load Limit.
Maximum Proof Load is 2 times the Working Load Limit.

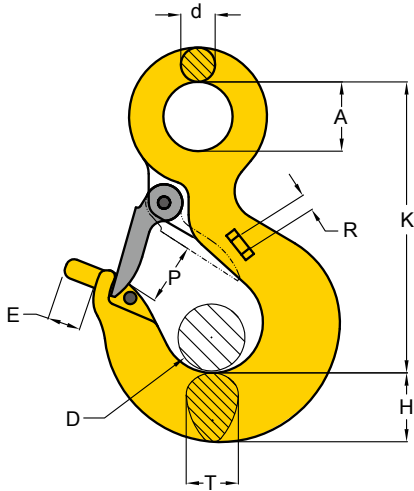

ROV: Remotely Operated Vehicle

- Forged alloy steel, quenched and tempered.
- Designed specifically for ROV application.
- Individually stamped with the Working Load Limit.
- Shackle Bows are painted yellow to ensure ease of sight in water.

ROV Eye Sling Hook (ROV: Remotely Operated Vehicle)

Item No.	Working Load Limit	Dimensions (inch)									N.W.
	tonnes*	A	D	d	E	H	K	P	R	T	lbs
8-921-03	3.0	1.26	0.98	0.59	0.78	1.14	4.80	0.98	0.31	0.95	2.2
8-921-05	5.0	1.57	1.22	0.71	0.78	1.46	5.87	1.22	0.31	1.22	4.6
8-921-07	7.0	2.00	1.54	0.95	0.78	1.89	7.56	1.54	0.31	1.42	8.8
8-921-11	11.0	2.48	2.24	1.10	1.18	2.20	9.13	2.24	0.31	1.85	15.4
8-921-15	15.0	2.84	2.44	1.30	1.18	2.52	10.24	2.44	0.31	2.05	20.7
8-921-22	22.0	3.58	3.19	1.57	1.96	2.91	12.50	3.19	0.39	2.68	40.9
8-921-30	30.0	3.58	3.27	1.77	1.96	3.62	13.66	3.27	0.39	2.99	68.6

★ Minimum Ultimate Load is 4 times the Working Load Limit.
Maximum Proof Load is 2 times the Working Load Limit.

Item No.	Working Load Limit	Dimensions (mm)									N.W.
	tonnes	A	D	d	E	H	K	P	R	T	kg
8-921-03	3.0	32	25	15	20	29	122	25	8	24	1.0
8-921-05	5.0	40	31	18	20	37	149	31	8	31	2.1
8-921-07	7.0	51	39	24	20	48	192	39	8	36	4.0
8-921-11	11.0	63	57	28	30	56	232	57	8	47	7.0
8-921-15	15.0	72	62	33	30	64	260	62	8	52	9.4
8-921-22	22.0	91	81	40	50	74	318	81	10	68	18.6
8-921-30	30.0	91	83	45	50	92	347	83	10	76	31.2

★ Minimum Ultimate Load is 4 times the Working Load Limit.
Maximum Proof Load is 2 times the Working Load Limit.

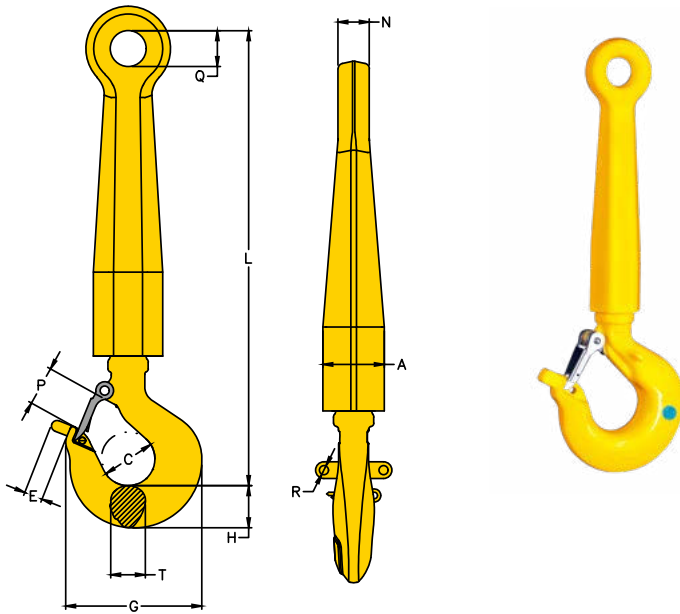

ROV: Remotely Operated Vehicle

- Forged alloy steel, quenched and tempered.
- Designed specifically for ROV application.
- Individually stamped with the Working Load Limit.
- Shackle Bows are painted yellow to ensure ease of sight in water.

ROV Shank Hook (ROV: Remotely Operated Vehicle)

Item No.	Working Load Limit tonnes*	Dimensions (inch)											N.W. lbs
		A	C	E	G	H	L	N	P	Q	R	T	
8-931-05	5.4	2.17	1.89	0.79	4.80	1.50	16.03	1.10	1.38	1.26	0.32	1.22	13.2
8-931-08	8.0	2.17	2.44	0.79	6.30	1.89	16.97	1.10	1.69	1.26	0.32	1.38	16.7
8-931-11	11.5	2.56	3.03	1.18	7.72	2.21	19.18	1.58	2.40	1.97	0.32	1.85	30.6
8-931-16	16.0	2.56	3.27	1.18	8.70	2.52	19.41	1.58	2.84	1.97	0.32	2.21	35.0
8-931-22	22.0	3.35	4.29	1.97	10.91	2.99	22.25	2.05	3.47	2.56	0.39	2.68	68.2
8-931-32	31.5	3.35	5.00	1.97	13.90	3.58	23.47	2.05	3.50	2.56	0.39	2.99	98.1

★ Minimum Ultimate Load is 4 times the Working Load Limit.
Maximum Proof Load is 2 times the Working Load Limit.

Item No.	Working Load Limit tonnes*	Dimensions (mm)											N.W. kg
		A	C	E	G	H	L	N	P	Q	R	T	
8-931-05	5.4	55	48	20	122	38	407	28	35	32	8	31	6.0
8-931-08	8.0	55	62	20	160	48	431	28	43	32	8	35	7.6
8-931-11	11.5	65	77	30	196	56	487	40	61	50	8	47	13.9
8-931-16	16.0	65	83	30	221	64	493	40	72	50	8	56	15.9
8-931-22	22.0	85	109	50	277	76	565	52	88	65	10	68	31.0
8-931-32	31.5	85	127	50	353	91	596	52	89	65	10	76	44.6

★ Minimum Ultimate Load is 4 times the Working Load Limit.
Maximum Proof Load is 2 times the Working Load Limit.



Safety is our first priority™

An ISO 9001 Registered Company



YOKE INDUSTRIAL CORP.

No. 39, 33rd Road,
Taichung Industrial Park,
Taichung 407,
TAIWAN
Tel: +886-4-2350-8088
Fax: +886-4-2350-1001
E-mail: info@mail.yoke.net
www.yoke.net

Quality Management System:

