

YOKE®

Safety is our first priority™

TECH FOR SAFETY



2023

General Catalog No. 8-2023

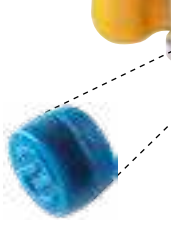
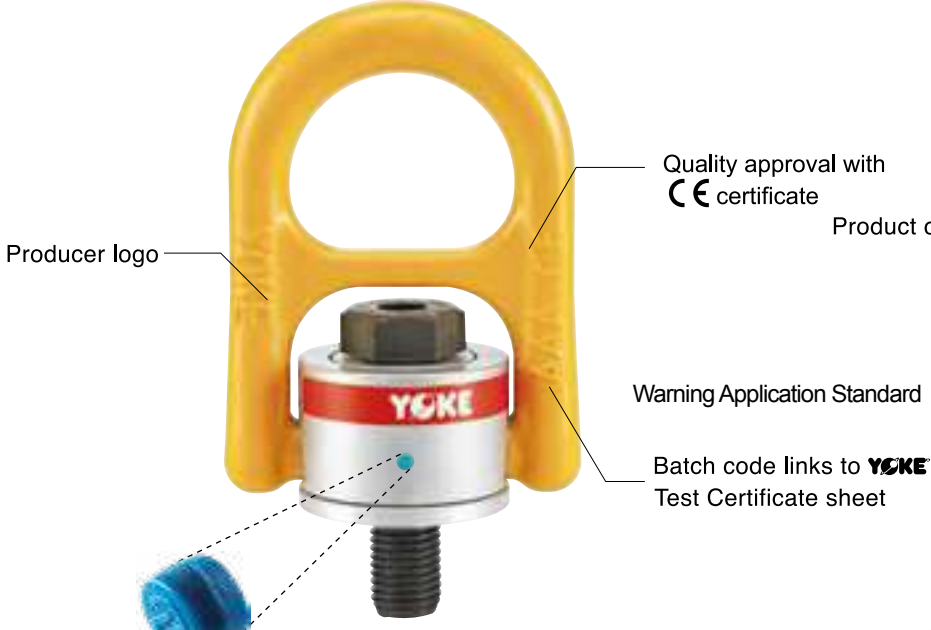
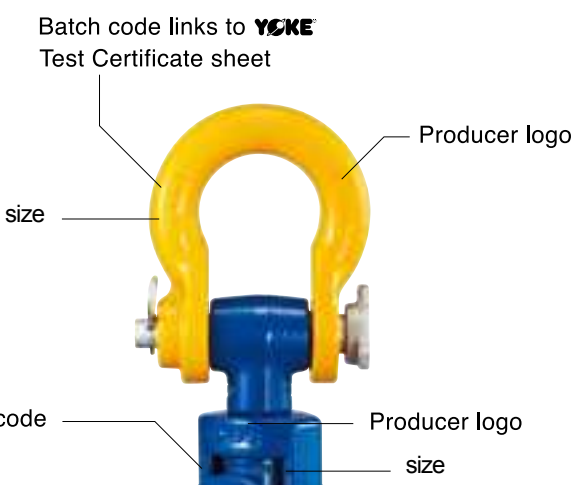
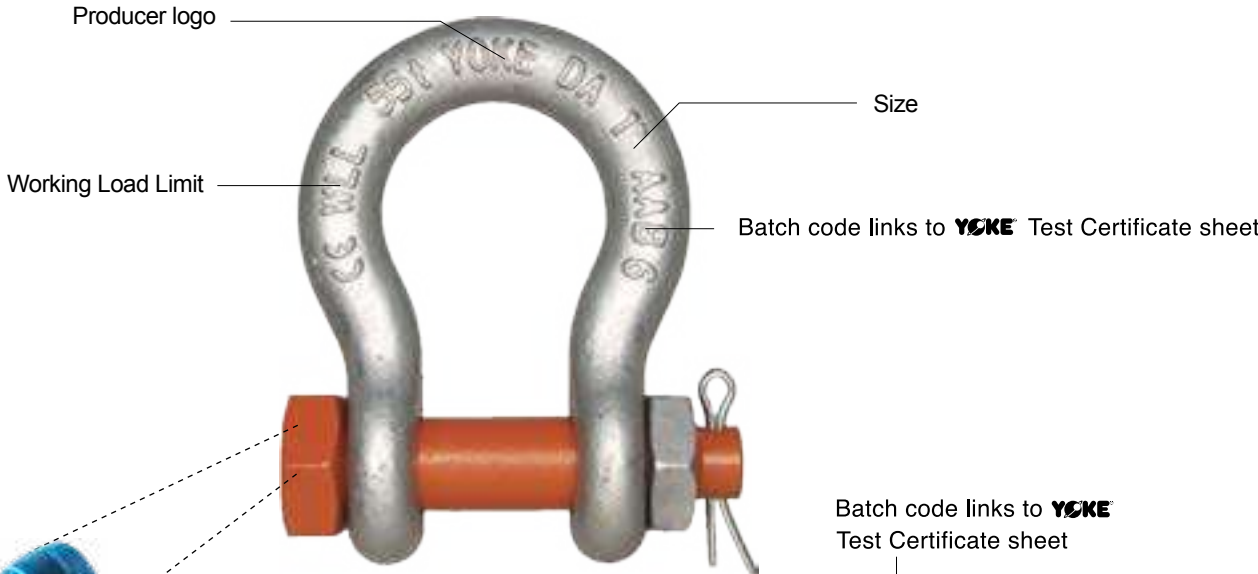

Digital Chip embedded with Certificate for serial Traceability

Quality Management System and Product Type Approval:



[www.yoke.net/
thirdpartycertificate](http://www.yoke.net/thirdpartycertificate)

Statement of LIMITED WARRANTY

Purchaser and YOKE expressly agree that YOKE’s warranty with respect to sale of its products is LIMITED solely to YOKE’s choice of repair, replacement or refund of the purchase price of any product.

Purchaser and YOKE expressly agree that the remedies provided in this section are the purchaser’s exclusive remedies in connection with the purchase or use of the product. Purchaser and YOKE expressly agree that in no event shall YOKE be liable for any incidental or consequential damages in connection with the purchase or use of the product.

All other warranties, including express warranties and the implied warranties of merchantability and fitness for a particular purpose are hereby disclaimed. Purchaser hereby waives all other warranties, rights and remedies arising by law or otherwise including, but not limited to, express warranties, the implied warranty of merchantability, any implied warranties arising from course of performance, course of dealing or usage of trade, and implied warranty of fitness for a particular purpose. Additionally, yoke hereby disclaims any of its obligations or liabilities arising from statute, warranty, contract, tort or negligence. Any modification made to yoke products will void the limited warranty where applicable, and will also void any third party accreditations that may apply such as abs, dnv, etc.

Complete Agreement: This Warranty between purchaser and YOKE is complete. All prior or contemporaneous discussions, representations and/or understanding are merged into this Warranty.

All prior or contemporaneous agreements between the parties are superseded by this Warranty. Choice of Law: Any dispute about the interpretation of this Warranty shall be governed by the laws of Taiwan, The Republic of China.

Resolution of Disputes: Purchaser and YOKE expressly agree that any dispute arising out of the purchase, use or operation of the purchased product shall, upon written notice to the other party, be resolved through binding arbitration. The arbitration shall be governed by the then existing rules of the Arbitration Association of The Republic of China. The location of any arbitration shall be Taichung, Taiwan, The Republic of China. The substantive laws of The Republic of China shall govern the arbitration to the extent they are not in conflict with the then existing rules of the Arbitration Association of The Republic of China. In no event shall YOKE be liable for incidental or consequential damages as part of the arbitration award. The award, decision, or filing rendered by the arbitration shall be final, and judgment may be entered upon it in accordance with the applicable law in any court having appropriate jurisdiction.

YOKE INDUSTRIAL CORP.

Quality Control, Testing, and Detecting during manufacturing

YOKE runs a constant and strict production facility with quality control in every manufacturing stage from raw materials to the completed product. YOKE is an ISO 9001 certified company and has Type Approval by the major international authorities from Deutsche Gesetzliche Unfallversicherung (DGUV) , ABS, API, and DNV which ensure the quality research and development (R&D) department and unsurpassed product engineering.

■ Magnaflux Crack Detection:

All forged components are individually magnaflux detected after heat treatment.

■ Proof Load Testing:

YOKE Yellow Points are proof load qualified to 2.5 times the Working Load Limit within 1% permanent deformation.

■ Dynamic Fatigue Testing:

Batch samples of YOKE Yellow Points are Dynamic Fatigue Tested to 20,000 cycles at 1.5 times the Working Load Limit.

■ Ultimate Breaking Load Testing:

Batch samples are tested in a static tensile testing machine until failure. Minimum ultimate force equals to the Working Load Limit times safety factor.

■ Spectrographic Analysis:

To assure of the proper metallurgy content of all raw materials.





Safety is our first priority TM

- Quality, Reliability, Innovation -

P.8
Yellow Point



P.77
Supra Digital Chips



P.87
Grade 100 Lifting
Chain Fittings



P.143
Grade 80 Lifting
Chain Fittings



P.160
DA Series



P.181
ROV
Hooks, Shackles



P.184
Snatch Blocks
Derrick Block



P.204
Socket



P.209
Shackle
Wire Rope Clip
Angular Contact Bearing Swivels

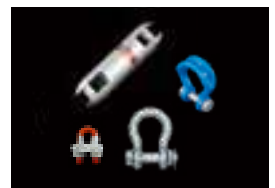



Powered by **RiConnect**

Digital Chip embedded
with Certificate
for serial Traceability



YOKE Go Digital, Powered by RiConnect

YOKE's Digital Yellow Point makes product traceability and Pre-use Check the most simple task ever.

You can obtain and share information through the third party App, RiConnect, by NFC enabled smart phone. Product information, Safe Use Instructions and manufacturer's Certificate (EC Declaration of Conformity/ UK Declaration of Conformity/Declaration of Conformity or Certificate of Conformance or Manufacturer Certificate) can be retrieved simply with a smart phone or tablet.

The unique design of the proprietary wafer-antenna Digital Chip construction, enables Smart phone NFC and RFID Pre-use Check inspection to be more intuitive and efficient.

Tech for Safety!









Safety is our first priority™

- Quality, Reliability, Innovation -



YOKE YP Size & WLL Chart (Metric Thread)



Thread	8-211		8-231		8-203		8-251		8-271		8-291K		8-S291	
	WLL (t)	Wieght (kg)	WLL (t)	Wieght (kg)	WLL (t)	Wieght (kg)	WLL (t)	Wieght (kg)	WLL (t)	Wieght (kg)	WLL (t)	Wieght (kg)	WLL (t)	Wieght (kg)
M 6											0.10	0.10		
M 8	0.30	0.30	0.50	0.20	0.50	0.40	0.30	0.30	0.40	0.20	0.30	0.10		
M10	0.63	0.40	0.70	0.30	0.55	0.50	0.50	0.40	0.60	0.20	0.40	0.10		
M12	1.00	0.50	1.00	0.30	1.30	1.70	0.70	0.40	0.70	0.30	0.75	0.20	0.50	0.20
M14	1.20	0.50	1.50	0.90			1.00	0.40						
M16	1.50	0.60	2.00	0.90	2.40	1.80	1.40	0.50	1.50	0.50	1.50	0.40	1.00	0.30
M18	2.00	1.30	2.50	1.90										
M20	2.50	1.60	3.00	1.10	2.70	1.80	1.70	0.50	2.50	1.00	2.30	0.60	2.00	0.60
					3.75	4.00	2.50	1.00						
M24	4.00	1.90	5.00	2.70	5.25	4.20	1.70	0.50	4.00	2.20	3.20	1.10	2.50	1.00
							4.00	1.50						
M27	4.00	2.90	5.60	4.70										
M30	5.00	3.10	7.80	5.10	8.75	6.60	4.00	1.50			4.50	2.10		
							6.70	2.50	6.00	4.50				
							8.00	3.70	6.70	4.50				
M36	7.00	3.10	10.00	5.60	10.00	6.90	10.00	3.90	10.00	4.60	7.00	3.70		
	8.00	5.90	12.50	10.20	12.50	15.00								
					13.75	15.00								
M42	10.00	6.30	15.60	10.60	15.60	16.00	12.50	4.00	13.00	5.50	9.00	5.80		
	15.00	10.90					13.00	7.40						
M45							12.50	4.10						
							17.00	7.50						
M48	20.00	12.10	20.00	12.00	16.90	16.00	12.50	4.40	14.00	6.10	12.00	8.60		
							17.00	7.70						
M52							17.00	7.90	20.00	10.50				
M56			22.00	14.30			18.00	8.10	20.00	10.70	16.00	11.00		
M64			22.50	16.60			20.00	9.30	20.00	11.60	18.00	11.80		
							28.00	16.40						
M72							28.00	17.70	40.00	30.60				
							35.00	24.80						
							40.00	30.10						
M80							35.00	25.30						
							40.00	31.90	40.00	31.60				
							35.00	27.80						
M90							40.00	34.20	40.00	33.90				
							40.00	35.20						
M100							40.00							

* Design Factor 4:1

YOKE YP Size & WLL Chart (UNC Thread)



Thread	8-212		8-232		8-204		8-252		8-272		8-292K	
	WLL (t)	Wiegth (lbs)	WLL (t)	Wiegth (lbs)	WLL (t)	Wiegth (lbs)	WLL (t)	Wiegth (lbs)	WLL (t)	Wiegth (lbs)	WLL (t)	Wiegth (lbs)
5/16					0.45	0.90					0.30	0.30
3/8					0.56	0.90	0.50	1.00			0.40	0.30
1/2	1.00	1.00	1.00	0.60	1.38	3.70	0.70	1.00	0.70	0.70	0.75	0.50
5/8	1.50	1.30	2.00	2.00	2.25	4.00	1.40	1.00	1.50	1.20	1.50	0.90
3/4					2.75	4.00						
	2.50	2.90	3.00	2.10	3.88	8.80	2.50	2.10	2.00	1.20	2.30	1.40
7/8	2.50	2.80	3.75	5.00	4.50	9.30			2.50	2.20	2.30	1.50
1	4.00	4.30	5.00	3.40	5.63	9.50	4.00	3.30	4.00	4.80	3.20	2.50
1 1/4	5.00	6.80					6.70	5.30				
			7.81	11.20	8.50	14.50	8.00	8.10	6.00	9.90	4.50	4.70
1 1/2	8.00	12.90	12.5	22.30	13.63	35.20	10.00	8.30	10.00	10.00	7.00	8.70
1 3/4	15.00	24.50					12.50	8.80	13.00	12.10	9.00	12.70
2	20.00	27.20					12.50	9.70	14.00	13.50		
			20.00	28.70	17.00	35.20	17.00	16.70			12.00	19.60
2 1/4			22.00	34.20			18.00	17.80	20.00	23.10		
2 1/2			22.50	39.70			20.00	19.60				
							28.00	36.10	20.00	23.50		
3												
3 1/2							35.00	55.70				
4												

* Design Factor 4:1

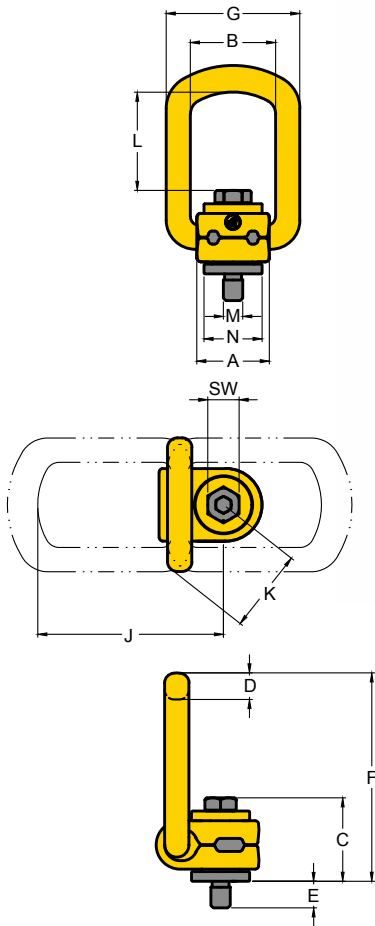

Digital Chip embedded with Certificate for serial Traceability

- Rotates through 360° and pivot 90°.
- Manufactured from alloy steel, quenched and tempered.
- Tested in accordance with EN1677-1.
- Certified by DGUV GS-OA 15-04.
- Load rated parts are 100% magnaflux crack detected.
- Individual forged parts and cap screw are traceable to Test Certification.
- Bolts are Metric thread.
- Proof tested to 2.5 times the WLL.
- Fatigue rated to 20,000 cycles at 1.5 times the WLL.
- All YOKE Lifting points meet or exceed all the requirements of ASME B30.26.
- Quick and simple assembly, just a tapped hole is required.

- » United States Patent: 10607128
- » UK Patent: 3627396
- » German Patent: 602018032891.2
- » Italy Patent: 3627396
- » Japan Patent: 3219858

- » China Patent: ZL 2012 1 0131962.1
- » Taiwan Patent: 1468602

Digital Lifting Point Metric Thread (8-211)

Item No.	Working Load Limit tonnes	Thread version			Dimensions											Torque	
		M	E	Pitch DIN13	A	B	C	D	F	G	SW	J	K	L	N	in Nm	N.W. kg
8-211-003	0.30	M 8	12	1.25	30	35	35	11	86	55	13	77	34	41	24	30	0.3
8-211-006	0.63	M 10	15	1.50	30	35	36	11	86	55	17	77	34	40	24	60	0.4
8-211-010	1.00	M 12	18	1.75	33	38	44	14	99	57	19	89	38	42	31	100	0.5
8-211-012	1.20	M 14	21	2.00	33	38	45	14	99	57	22	89	38	40	31	120	0.5
8-211-015	1.50	M 16	24	2.00	33	38	46	14	99	57	24	89	38	40	31	150	0.6
8-211-020	2.00	M 18	27	2.50	50	54	57	16	143	82	30	132	53	70	45	200	1.3
8-211-025	2.50	M 20	30	2.50	50	54	56	16	143	82	30	132	53	70	49	250	1.6
8-211-040	4.00	M 24	36	3.00	50	54	59	16	143	82	36	132	53	67	45	400	1.9
8-211-042	4.00	M 27	38	3.00	60	65	79	23	171	99	41	153	64	69	59	400	2.9
8-211-050	5.00	M 30	49	3.50	60	65	81	23	171	99	46	153	64	67	59	500	3.1
8-211-070	7.00	M 36	56	4.00	60	65	75	23	171	99	55	153	64	74	59	700	3.1
8-211-080	8.00	M 36	62	4.00	77	85	101	27	225	124	55	205	80	97	69	800	5.9
8-211-100	10.00	M 42	72	4.50	77	85	104	27	225	124	65	205	80	94	69	1000	6.3
8-211-150	15.00	M 42	63	4.50	95	104	112	36	258	158	65	230	99	110	98	1500	10.9
8-211-200	20.00	M 48	72	5.00	95	104	120	36	260	158	75	230	99	104	98	2000	12.1

* Design Factor 4:1



Kind of attachment											
Number of legs		1	2	1	2	2	2	2	3-4	3-4	3-4
Load direction		0°	0°	90°	90°	0-45°	45°- 60°	unsymm.	0 - 45°	45°- 60°	unsymm.
Item No.	Thread	WLL(t)									
8-211-003	M 8	0.30	0.60	0.30	0.60	0.42	0.30	0.30	0.63	0.45	0.30
8-211-006	M 10	0.63	1.26	0.63	1.26	0.88	0.63	0.63	1.32	0.95	0.63
8-211-010	M 12	1.00	2.00	1.00	2.00	1.40	1.00	1.00	2.10	1.50	1.00
8-211-012	M 14	1.20	2.40	1.20	2.40	1.68	1.20	1.20	2.52	1.80	1.20
8-211-015	M 16	1.50	3.00	1.50	3.00	2.10	1.50	1.50	3.15	2.25	1.50
8-211-020	M 18	2.00	4.00	2.00	4.00	2.80	2.00	2.00	4.20	3.00	2.00
8-211-025	M 20	2.50	5.00	2.50	5.00	3.50	2.50	2.50	5.25	3.75	2.50
8-211-040	M 24	4.00	8.00	4.00	8.00	5.60	4.00	4.00	8.40	6.00	4.00
8-211-042	M 27	4.00	8.00	4.00	8.00	5.60	4.00	4.00	8.40	6.00	4.00
8-211-050	M 30	5.00	10.00	5.00	10.00	7.00	5.00	5.00	10.50	7.50	5.00
8-211-070	M 36	7.00	14.00	7.00	14.00	9.80	7.00	7.00	14.70	10.50	7.00
8-211-080	M 36	8.00	16.00	8.00	16.00	11.20	8.00	8.00	16.80	12.00	8.00
8-211-100	M 42	10.00	20.00	10.00	20.00	14.00	10.00	10.00	21.00	15.00	10.00
8-211-150	M 42	15.00	30.00	15.00	30.00	21.00	15.00	15.00	31.50	22.50	15.00
8-211-200	M 48	20.00	40.00	20.00	40.00	28.00	20.00	20.00	42.00	30.00	20.00

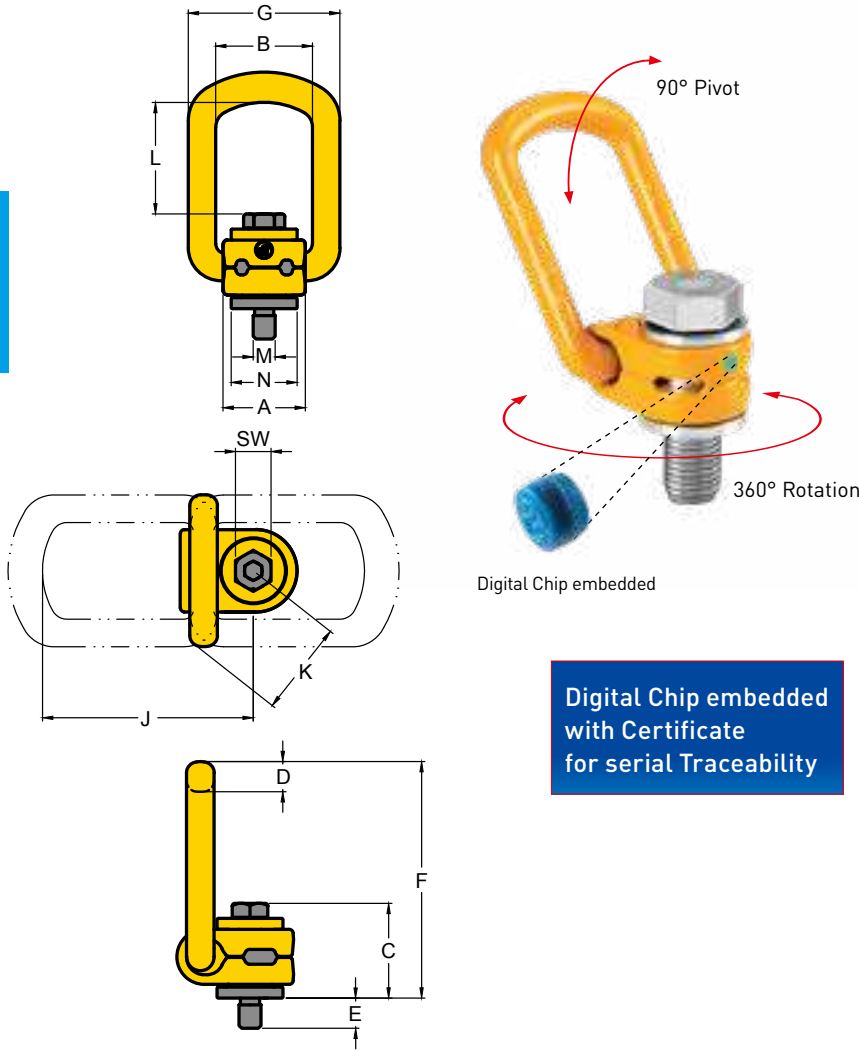

Digital Chip embedded with Certificate for serial Traceability

- Rotates through 360° and pivots 90°.
- Manufactured from alloy steel, quenched and tempered.
- Tested in accordance with EN1677-1.
- Load rated parts are 100% magnaflux crack detected.
- Individual forged parts and cap screw are traceable to Test Certification.
- Bolts are UNC thread.
- Proof tested to 2.5 times the WLL.
- Fatigue rated to 20,000 cycles at 1.5 times the WLL.
- All YOKE Lifting points meet or exceed all the requirements of ASME B30.26.
- Quick and simple assembly, just a tapped hole is required.

- » United States Patent: 10607128
- » UK Patent: 3627396
- » German Patent: 602018032891.2
- » Italy Patent: 3627396
- » Japan Patent: 3219858
- » China Patent: ZL 2012 1 0131962.1
- » Taiwan Patent: 1468602

Digital Lifting Point

UNC Thread (8-212)

Item No.	Working Load Limit	Thread version			Dimensions										Torque		N.W.	
		M	E	TPI	A	B	C	D	F	G	SW	J	K	L	N	in		
		tonnes	inch	inch							mm							Nm
8-212-010	1.0	1/2	0.94	13.0UNC	1.30	1.48	1.73	0.53	3.90	2.24	3/4	3.49	1.49	1.62	1.22	100	1.0	
8-212-015	1.5	5/8	1.46	11.0UNC	1.30	1.48	1.81	0.53	3.90	2.24	15/16	3.49	1.49	1.56	1.22	150	1.3	
8-212-020	2.5	3/4	1.46	10.0UNC	1.97	2.13	2.16	0.65	5.62	3.22	1 1/8	5.23	2.09	2.77	1.93	200	2.9	
8-212-025	2.5	7/8	1.46	9.0UNC	1.97	2.13	2.24	0.65	5.62	3.22	1 5/16	5.23	2.09	2.69	1.93	250	2.8	
8-212-040	4.0	1	1.61	8.0UNC	1.97	2.13	2.34	0.65	5.62	3.22	1 1/2	5.23	2.09	2.63	1.77	400	4.3	
8-212-050	5.0	1 1/4	2.11	7.0UNC	2.36	2.56	3.21	0.89	6.70	3.90	1 7/8	6.00	2.53	2.60	2.32	500	6.8	
8-212-080	8.0	1 1/2	2.44	6.0UNC	3.03	3.35	4.01	1.04	8.85	4.88	2 1/4	8.04	3.15	3.80	2.72	800	12.9	
8-212-150	15.0	1 3/4	2.60	5.0UNC	3.74	4.09	4.41	1.42	10.16	6.22	2 5/8	9.07	3.88	4.33	3.86	1500	24.5	
8-212-200	20.0	2	2.80	4.5UNC	3.74	4.09	4.72	1.42	10.24	6.22	3	9.07	3.88	4.09	3.86	2000	27.2	

* Design Factor 4:1



Kind of attachment											
Number of legs	Thread	1	2	1	2	2	2	2	3-4	3-4	3-4
Load direction	Thread	0°	0°	90°	90°	0-45°	45°- 60°	unsymm.	0 - 45°	45°- 60°	unsymm.
Item No.	Inch	WLL(t)									
8-212-010	1/2	1.0	2	1.0	2	1.4	1.0	1.0	2.10	1.50	1.0
8-212-015	5/8	1.5	3	1.5	3	2.1	1.5	1.5	3.15	2.25	1.5
8-212-020	3/4	2.5	5	2.5	5	3.5	2.5	2.5	5.25	3.75	2.5
8-212-025	7/8	2.5	5	2.5	5	3.5	2.5	2.5	5.25	3.75	2.5
8-212-040	1	4.0	8	4.0	8	5.6	4.0	4.0	8.40	6.00	4.0
8-212-050	1 1/4	5.0	10	5.0	10	7.0	5.0	5.0	10.5	7.50	5.0
8-212-080	1 1/2	8.0	16	8.0	16	11.2	8.0	8.0	16.8	12.0	8.0
8-212-150	1 3/4	15.0	30	15.0	30	21.0	15.0	15.0	31.5	22.5	15.0
8-212-200	2	20.0	40	20.0	40	28.0	20.0	20.0	42.0	30.0	20.0

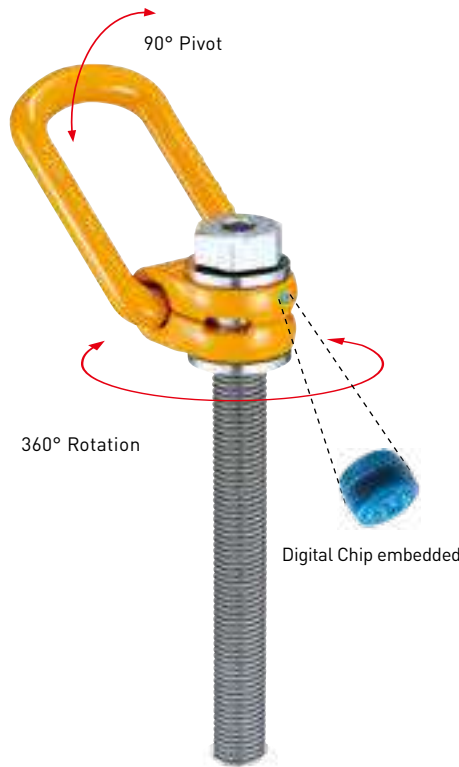
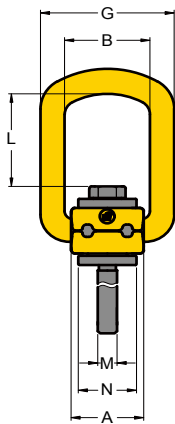
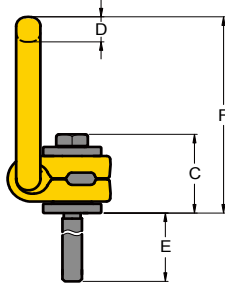
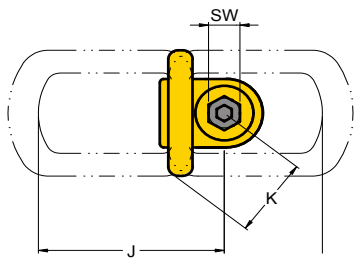

- Rotates through 360° and pivots 90°.
- Manufactured from alloy steel, quenched and tempered.
- Tested in accordance with EN1677-1.
- Load rated parts are 100% magnaflux crack detected.
- Individual forged parts and cap screw are traceable to Test Certification.
- Bolts are Metric thread.
- Proof tested to 2.5 times the WLL.
- Fatigue rated to 20,000 cycles at 1.5 times the WLL.
- All YOKE Lifting points meet or exceed all the requirements of ASME B30.26.
- Quick and simple assembly, just a tapped hole is required.

- » United States Patent: 10607128
- » UK Patent: 3627396
- » German Patent: 602018032891.2
- » Italy Patent: 3627396
- » Japan Patent: 3219858
- » China Patent: ZL 2012 1 0131962.1
- » Taiwan Patent: I468602

Digital Chip embedded with Certificate for serial Traceability

Digital Lifting Point, Long Bolt

Metric Thread (8-211L)

Item No.	Working Load Limit	Thread version			Dimensions											Torque in Nm	N.W. kg
		M	E	Pitch	A	B	C	D	F	G	SW	J	K	L	N		
	tonnes	mm	mm	DIN13	mm												
8-211-003/105L	0.30	M 8	76	1.25	30	35	35	11	86	55	13	77	34	41	24	30	0.4
8-211-006/125L	0.63	M 10	96	1.50	30	35	36	11	86	55	17	78	34	40	24	60	0.4
8-211-010/150L	1.00	M 12	114	1.75	33	38	44	14	99	57	19	89	38	42	31	100	0.5
8-211-015/185L	1.50	M 16	149	2.00	33	38	46	14	99	57	24	89	38	40	31	150	0.7
8-211-025/230L	2.50	M 20	187	2.50	50	54	56	16	142	82	30	132	53	70	49	250	1.7
8-211-040/265L	4.00	M 24	221	3.00	50	54	59	16	143	82	36	132	53	67	45	400	2.0
8-211-050/340L	5.00	M 30	279	3.50	60	65	81	23	170	99	46	153	64	67	59	500	4.3
8-211-080/300L	8.00	M 36	222	4.00	77	85	101	27	225	124	55	205	80	97	69	800	6.9
8-211-100/350L	10.00	M 42	272	4.50	77	85	104	27	225	124	65	204	79	94	69	1000	7.9
8-211-150/350L	15.00	M 42	264	4.50	95	104	112	36	258	158	65	229	98	110	98	1500	13.5
8-211-200/385L	20.00	M 48	295	5.00	95	104	120	36	260	158	75	230	99	104	98	2000	15.5

* Design Factor 4:1



Kind of attachment											
Number of legs	Load direction	1	2	1	2	2	2	2	3-4	3-4	3-4
Item No.	Thread	0°	0°	90°	90°	0-45°	45°- 60°	unsymm.	0 - 45°	45°- 60°	unsymm.
		WLL(t)									
8-211-003/105L	M 8	0.30	0.60	0.30	0.60	0.42	0.30	0.30	0.63	0.45	0.30
8-211-006/125L	M10	0.63	1.26	0.63	1.26	0.88	0.63	0.63	1.32	0.95	0.63
8-211-010/150L	M12	1.00	2.00	1.00	2.00	1.40	1.00	1.00	2.10	1.50	1.00
8-211-015/185L	M16	1.50	3.00	1.50	3.00	2.10	1.50	1.50	3.15	2.25	1.50
8-211-025/230L	M20	2.50	5.00	2.50	5.00	3.50	2.50	2.50	5.25	3.75	2.50
8-211-040/265L	M24	4.00	8.00	4.00	8.00	5.60	4.00	4.00	8.40	6.00	4.00
8-211-050/340L	M30	5.00	10.00	5.00	10.00	7.00	5.00	5.00	10.50	7.50	5.00
8-211-080/300L	M36	8.00	16.00	8.00	16.00	11.20	8.00	8.00	16.80	12.00	8.00
8-211-100/350L	M42	10.00	20.00	10.00	20.00	14.00	10.00	10.00	21.00	15.00	10.00
8-211-150/350L	M42	15.00	30.00	15.00	30.00	21.00	15.00	15.00	31.50	22.50	15.00
8-211-200/385L	M48	20.00	40.00	20.00	40.00	28.00	20.00	20.00	42.00	30.00	20.00

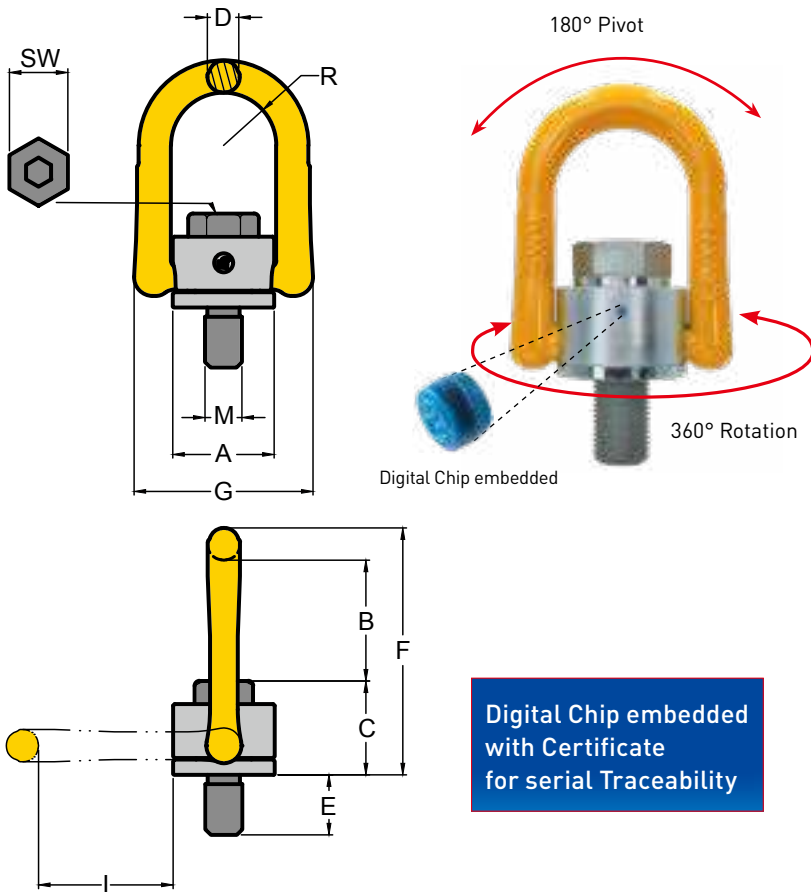

- Rotates through 360° and pivots 180°, and simultaneously allows lifting from any direction.
- Manufactured from forged alloy steel, quenched and tempered.
- Tested in accordance with EN1677-1.
- Load rated parts are 100% magnaflux crack detected.
- Individual forged parts and cap screw are traceable to Test Certification.
- Bolts are Metric thread.
- Proof tested to 2.5 times the WLL.
- Fatigue rated to 20,000 cycles at 1.5 times the WLL.
- All YOKE Lifting points meet or exceed all the requirements of ASME B30.26.
- Quick and simple assembly, just a tapped hole is required.

- » United States Patent: 10607128
- » UK Patent: 3627396
- » German Patent: 602018032891.2
- » Italy Patent: 3627396
- » Japan Patent: 3219858
- » China Patent: ZL 2012 1 0131962.1
- » Taiwan Patent: 1468602

Digital Anchor Point

Metric Thread (8-231)

Item No.	Working Load Limit	Thread version			Dimensions								Torque in	N.W.	
		M	E	Pitch	A	B	C	D	F	G	R	SW			I
		mm	mm	DIN13	mm	mm	mm	mm	mm	mm	mm	mm			mm
8-231-005	0.5	M 8	12	1.25	33	42	28	11	80	58	17	13	44	30	0.2
8-231-007	0.7	M 10	15	1.50	33	41	29	11	80	58	17	17	44	60	0.3
8-231-010	1.0	M 12	20	1.75	33	39	31	11	80	58	17	19	44	100	0.3
8-231-015	1.5	M 14	21	2.00	50	56	45	17	116	90	27	22	63	120	0.9
8-231-020	2.0	M 16	24	2.00	50	54	46	17	116	90	27	24	63	150	0.9
8-231-025	2.5	M 18	27	2.50	65	77	57	20	155	108	34	30	86	200	1.9
8-231-030	3.0	M 20	34	2.50	51	52	49	17	116	90	27	30	63	250	1.1
8-231-050	5.0	M 24	36	3.00	72	81	59	25	163	126	37	36	88	400	2.7
8-231-056	5.6	M 27	38	3.00	87	96	79	30	204	148	46	41	110	400	4.7
8-231-078	7.8	M 30	48	3.50	87	94	81	30	204	148	46	46	110	500	5.1
8-231-100	10.0	M 36	54	4.00	87	90	85	30	204	148	46	55	110	1000	5.6
8-231-125	12.5	M 36	56	4.00	110	112	98	36	248	188	57	55	128	1000	10.2
8-231-156	15.6	M 42	63	4.50	110	101	108	36	248	188	57	65	128	1500	10.6
8-231-200	20.0	M 48	72	5.00	110	97	112	36	248	188	57	75	128	2000	12.0
8-231-220	22.0	M 56	84	5.50	123	116	121	36	274	202	64	85	146	2100	14.3
8-231-225	22.5	M 64	100	6.00	123	111	126	36	274	202	64	95	146	2200	16.6

* Design Factor 4:1



Kind of attachment											
Number of legs		1	2	1	2	2	2	2	3-4	3-4	3-4
Load direction		0°	0°	90°	90°	0-45°	45°- 60°	unsymm.	0 - 45°	45°- 60°	unsymm.
Item No.	Thread	WLL(t)									
8-231-005	M 8	0.8	1.6	0.5	1.0	0.7	0.5	0.5	1.10	0.80	0.5
8-231-007	M 10	1.2	2.4	0.7	1.4	1.0	0.7	0.7	1.50	1.10	0.7
8-231-010	M 12	1.5	3.0	1.0	2.0	1.4	1.0	1.0	2.10	1.50	1.0
8-231-015	M 14	2.4	4.8	1.5	3.0	2.1	1.5	1.5	3.20	2.30	1.5
8-231-020	M 16	3.2	6.4	2.0	4.0	2.8	2.0	2.0	4.20	3.00	2.0
8-231-025	M 18	5.0	10.0	2.5	5.0	3.5	2.5	2.5	5.30	3.80	2.5
8-231-030	M 20	4.5	9.0	3.0	6.0	4.2	3.0	3.0	6.30	4.50	3.0
8-231-050	M 24	9.0	18.0	5.0	10.0	7.0	5.0	5.0	10.50	7.50	5.0
8-231-056	M 27	9.5	19.0	5.6	11.2	7.8	5.6	5.6	11.80	8.40	5.6
8-231-078	M 30	12.0	24.0	7.8	15.6	10.9	7.8	7.8	16.40	11.70	7.8
8-231-100	M36	13.0	26.0	10.0	20.0	14.0	10.0	10.0	21.00	15.00	10.0
8-231-125	M 36	14.0	28.0	12.5	25.0	17.5	12.5	12.5	26.30	18.80	12.5
8-231-156	M 42	16.0	32.0	15.6	31.2	21.8	15.6	15.6	32.80	23.40	15.6
8-231-200	M 48	20.0	40.0	20.0	40.0	28.0	20.0	20.0	42.00	30.00	20.0
8-231-220	M 56	22.0	44.0	22.0	44.0	30.8	22.0	22.0	46.20	33.00	22.0
8-231-225	M 64	22.5	45.0	22.5	45.0	31.5	22.5	22.5	47.25	33.75	22.5

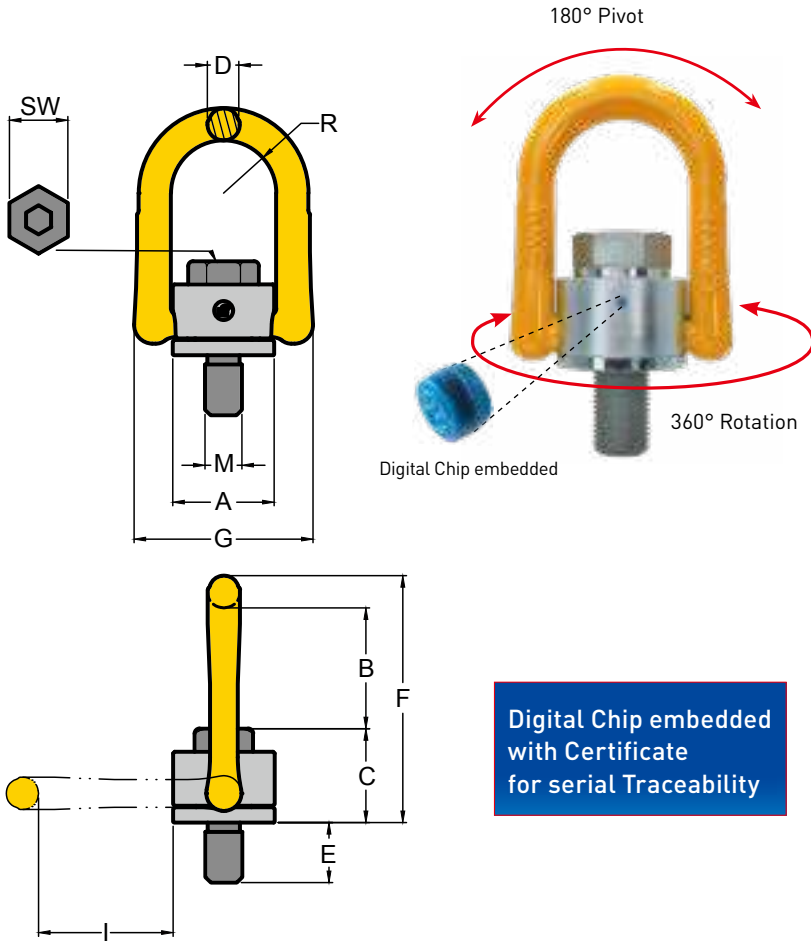

- Rotates through 360° and pivots 180°, and simultaneously allows lifting from any direction.
- Manufactured from forged alloy steel, quenched and tempered.
- Tested in accordance with EN1677-1.
- Load rated parts are 100% magnaflux crack detected.
- Individual forged parts and cap screw are traceable to Test Certification.
- Bolts are UNC thread.
- Proof tested to 2.5 times the WLL.
- Fatigue rated to 20,000 cycles at 1.5 times the WLL.
- All YOKE Lifting points meet or exceed all the requirements of ASME B30.26.
- Quick and simple assembly, just a tapped hole is required.

- » United States Patent: 10607128
- » UK Patent: 3627396
- » German Patent: 602018032891.2
- » Italy Patent: 3627396
- » Japan Patent: 3219858
- » China Patent: ZL 2012 1 0131962.1
- » Taiwan Patent: I468602

Digital Anchor Point

UNC Thread (8-232)

Item No.	Working Load Limit	Thread version			Dimensions								Torque		N.W.	
		M	E	TPI	A	B	C	D	F	G	R	SW	I			
		tonnes	inch	inch										Nm		lbs
8-232-010	0.80	1/2	0.81	13 UNC	1.30	1.55	1.20	0.41	3.16	2.29	0.67	3/4	1.72	100	0.6	
8-232-020	1.60	5/8	1.13	11 UNC	1.97	2.14	1.81	0.65	4.56	3.54	1.06	15/16	2.48	150	2.0	
8-232-030	2.40	3/4	1.54	10 UNC	2.01	2.06	1.89	0.65	4.56	3.54	1.06	1 1/8	2.46	250	2.1	
8-232-038	3.00	7/8	1.42	9 UNC	2.81	3.24	2.28	0.98	6.42	4.94	1.47	1 5/16	3.45	300	5.0	
8-232-050	4.00	1	1.61	8 UNC	2.81	3.18	2.34	0.98	6.42	4.94	1.47	1 1/2	3.45	400	3.4	
8-232-078	6.25	1 1/4	2.09	7 UNC	3.43	3.65	3.23	1.16	8.02	5.82	1.79	1 7/8	4.31	500	11.2	
8-232-125	10.00	1 1/2	2.40	6 UNC	4.33	4.38	4.05	1.42	9.80	7.40	2.24	2 1/4	5.04	800	22.3	
8-232-200	16.00	2	3.00	4.5 UNC	4.33	3.84	4.53	1.42	9.80	7.40	2.24	3	4.88	2000	28.7	
8-232-220	17.60	2 1/4	3.37	4.5 UNC	4.84	4.45	4.91	1.42	10.78	7.95	2.52	3 3/8	5.75	2100	34.2	
8-232-225	18.00	2 1/2	3.75	4 UNC	4.84	4.30	5.06	1.42	10.78	7.95	2.52	3 3/4	5.75	2200	39.7	

* Design Factor 5:1



Kind of attachment											
Number of legs	Thread	1	2	1	2	2	2	2	3-4	3-4	3-4
Load direction	Thread	0°	0°	90°	90°	0-45°	45°- 60°	unsymm.	0 - 45°	45°- 60°	unsymm.
Item No.	Inch	WLL(t)									
8-232-010	1/2	1.2	2.4	0.80	1.6	1.12	0.80	0.80	1.68	1.20	0.80
8-232-020	5/8	2.6	5.2	1.60	3.2	2.24	1.60	1.60	3.36	2.40	1.60
8-232-030	3/4	3.6	7.2	2.40	4.8	3.36	2.40	2.40	5.04	3.60	2.40
8-232-038	7/8	4.5	9.0	3.00	6.0	4.20	3.00	3.00	6.30	4.50	3.00
8-232-050	1	7.2	14.4	4.00	8.0	5.60	4.00	4.00	8.40	6.00	4.00
8-232-078	1 1/4	9.6	19.2	6.25	12.5	8.75	6.25	6.25	13.13	9.38	6.25
8-232-125	1 1/2	11.0	22.0	10.00	20.0	14.00	10.00	10.00	21.00	15.00	10.00
8-232-200	2	16.0	32.0	16.00	32.0	22.40	16.00	16.00	33.60	24.00	16.00
8-232-220	2 1/4	17.6	35.2	17.60	35.2	24.64	17.60	17.60	36.96	26.40	17.60
8-232-225	2 1/2	18.0	36.0	18.00	36.0	25.20	18.00	18.00	37.80	27.00	18.00

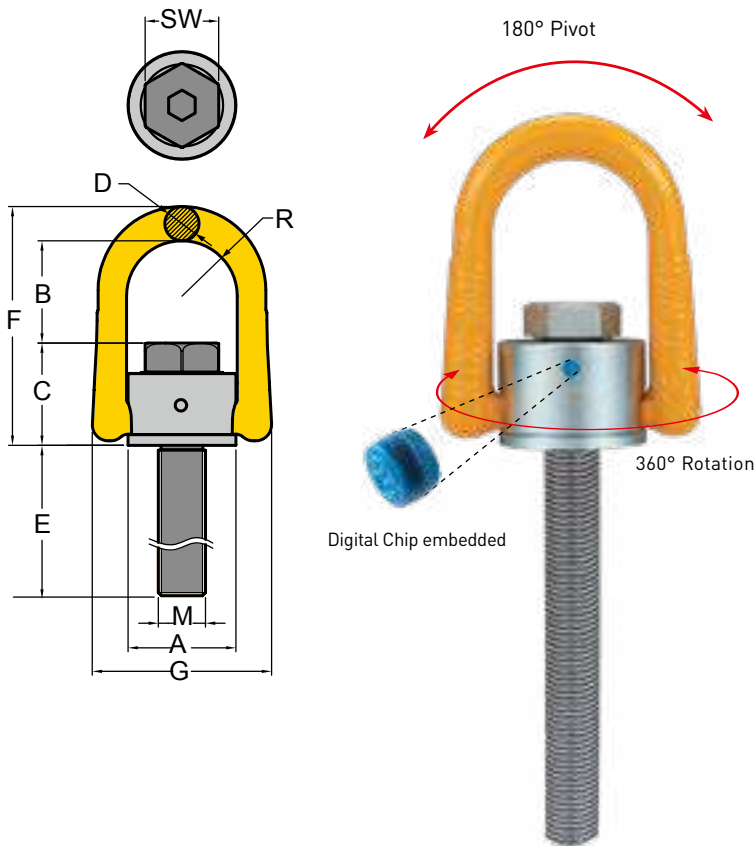

- Rotates through 360° and pivots 180°, and simultaneously allows lifting from any direction.
- Manufactured from forged alloy steel, quenched and tempered.
- Tested in accordance with EN1677-1.
- Load rated parts are 100% magnaflux crack detected.
- Individual forged parts and cap screw are traceable to Test Certification.
- Bolts are Metric thread.
- Proof tested to 2.5 times the WLL.
- Fatigue rated to 20,000 cycles at 1.5 times the WLL.
- All YOKE Lifting points meet or exceed all the requirements of ASME B30.26.
- Quick and simple assembly, just a tapped hole is required.

- » United States Patent: 10607128
- » UK Patent: 3627396
- » German Patent: 602018032891.2
- » Italy Patent: 3627396
- » Japan Patent: 3219858
- » China Patent: ZL 2012 1 0131962.1
- » Taiwan Patent: 1468602

Digital Chip embedded with Certificate for serial Traceability

Digital Anchor Point, Long Bolt Metric Thread (8-231L)

Item No.	Working Load Limit tonnes	Thread version			Dimensions								Torque in Nm	N.W. kg
		M	E	Pitch DIN13	A	B	C	D	F	G	R	SW		
8-231-005/105L	0.5	M 8	83	1.25	33	42	28	11	80	58	17	13	30	0.3
8-231-007/125L	0.7	M 10	103	1.50	33	41	29	11	80	58	17	17	60	0.4
8-231-010/150L	1.0	M 12	128	1.75	33	39	31	11	80	58	17	19	100	0.4
8-231-020/185L	2.0	M 16	149	2.00	50	54	46	17	116	90	27	24	150	1.0
8-231-030/230L	3.0	M 20	194	2.50	51	52	49	17	116	90	27	30	250	2.0
8-231-050/265L	5.0	M 24	222	3.00	72	81	59	25	163	126	37	36	400	2.8
8-231-078/340L	7.8	M 30	278	3.50	87	94	81	30	204	148	46	46	500	6.3
8-231-125/300L	12.5	M 36	226	4.00	110	112	98	36	248	188	57	55	1000	10.6
8-231-156/350L	15.6	M 42	268	4.50	110	101	108	36	248	188	57	65	1500	11.3
8-231-200/385L	20.0	M 48	303	5.00	110	97	112	36	248	188	57	75	2000	13.3

* Design Factor 4:1



Kind of attachment																				
	Item No.	Thread	WLL(t)																	
8-231-005/105L	M 8	0.8	1.6	0.5	1.0	0.7	0.5	0.5	1.1	0.8	0.5									
8-231-007/125L	M10	1.2	2.4	0.7	1.4	1.0	0.7	0.7	1.5	1.1	0.7									
8-231-010/150L	M12	1.5	3.0	1.0	2.0	1.4	1.0	1.0	2.1	1.5	1.0									
8-231-020/185L	M16	3.2	6.4	2.0	4.0	2.8	2.0	2.0	4.2	3.0	2.0									
8-231-030/230L	M20	4.5	9.0	3.0	6.0	4.2	3.0	3.0	6.3	4.5	3.0									
8-231-050/265L	M24	9.0	18.0	5.0	10.0	7.0	5.0	5.0	10.5	7.5	5.0									
8-231-078/340L	M30	12.0	24.0	7.8	15.6	10.9	7.8	7.8	16.4	11.7	7.8									
8-231-125/300L	M36	14.0	28.0	12.5	25.0	17.5	12.5	12.5	26.3	18.8	12.5									
8-231-156/350L	M42	16.0	32.0	15.6	31.2	21.8	15.6	15.6	32.8	23.4	15.6									
8-231-200/385L	M48	20.0	40.0	20.0	40.0	28.0	20.0	20.0	42.0	30.0	20.0									

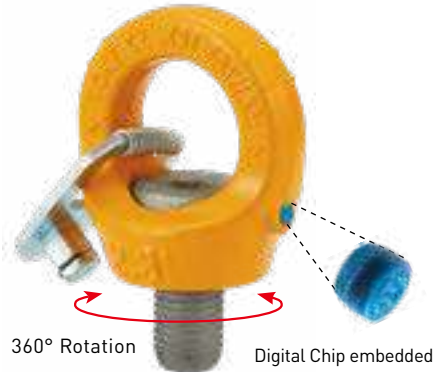
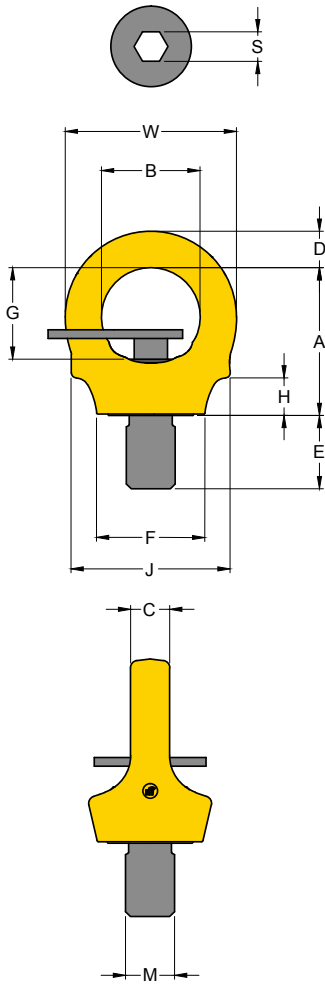

Digital Chip embedded with Certificate for serial Traceability

- Rotates through 360° adjustable in the direction of the load.
- Manufactured from alloy steel, quenched and tempered.
- Tested in accordance with EN1677-1.
- Certified by DGUV GS-OA 15-04
- Load rated parts are 100% magnaflux crack detected.
- Individual forged parts and cap screw are traceable to Test Certification.
- Bolts are Metric thread.
- Proof tested to 2.5 times the WLL.
- Fatigue rated to 20,000 cycles at 1.5 times the WLL.
- All YOKE Lifting points meet or exceed all the requirements of ASME B30.26.
- Quick and simple assembly, just a tapped hole is required.

Allen Key Patent

- » United States Patent: 10259691
- » Germany Patent: 202018100296
- » China Patent: ZL201721542303.1
- » Taiwan Patent: 1644848

- » Mexico Patent: 3423
- » Japan Patent: 3192016
- » China Patent: ZL 2014 2 0228663.4

- » China Patent: ZL 2012 1 0131962.1
- » Taiwan Patent: 1468602

- » United States Patent: 10607128
- » UK Patent: 3627396
- » German Patent: 602018032891.2
- » Italy Patent: 3627396
- » Japan Patent: 3219858

Digital Key Eye Point

Metric Thread (8-291K)

Item No.	Working Load Limit tonnes	Thread version			Dimensions										Torque		N.W. kg
		M	E	Pitch	A	B	C	D	F	G	H	J	S	W	Nm		
		mm	mm	DIN13	mm												
8-291K-001	0.10 NEW	M 6	9	1.00	30	20	7	7	23	19	4	33	6	34	5	0.1	
8-291K-003	0.30	M 8	12	1.25	38	25	9	9	25	24	6	41	6	44	10	0.1	
8-291K-004	0.40	M 10	15	1.50	38	25	9	9	25	24	6	41	6	44	10	0.1	
8-291K-007	0.75	M 12	18	1.75	45	30	10	11	33	30	9	47	8	52	10	0.2	
8-291K-015	1.50	M 16	24	2.00	52	35	14	13	35	34	11	56	10	61	30	0.4	
8-291K-023	2.30	M 20	30	2.50	60	40	16	15	44	37	15	65	12	70	70	0.6	
8-291K-032	3.20	M 24	36	3.00	72	49	19	18	53	47	19	78	14	84	150	1.1	
8-291K-045	4.50	M 30	45	3.50	91	61	24	22	62	59	23	95	17	105	350	2.1	
8-291K-070	7.00	M 36	54	4.00	110	73	29	27	76	72	31	114	22	126	410	3.7	
8-291K-090	9.00	M 42	63	4.50	128	83	34	32	89	81	38	132	24	147	550	5.8	
8-291K-120	12.00	M 48	72	5.00	145	95	38	37	105	94	44	150	27	168	550	8.6	
8-291K-140	16.00	M 56	84	5.50	148	102	40	43	124	92	49	166	27	178	800	11.0	
8-291K-150	18.00	M 64	96	6.00	148	102	40	43	124	92	49	166	27	178	800	11.8	

* Design Factor 4:1



Kind of attachment											
Number of legs	1	2	1	2	2	2	2	3-4	3-4	3-4	
Load direction	0°	0°	90°	90°	0-45°	45°- 60°	unsymm.	0 - 45°	45°- 60°	unsymm.	
Item No.	Thread	WLL(t)									
8-291K-001	M 6 NEW	0.5	1	0.10	0.2	0.14	0.10	0.10	0.21	0.15	0.10
8-291K-003	M 8	1.0	2	0.30	0.6	0.42	0.30	0.30	0.63	0.45	0.30
8-291K-004	M10	1.0	2	0.40	0.8	0.56	0.40	0.40	0.84	0.60	0.40
8-291K-007	M12	2.0	4	0.75	1.5	1.00	0.75	0.75	1.58	1.12	0.75
8-291K-015	M16	4.0	8	1.50	3.0	2.10	1.50	1.50	3.15	2.25	1.50
8-291K-023	M20	6.0	12	2.30	4.6	3.20	2.30	2.30	4.83	3.45	2.30
8-291K-032	M24	8.0	16	3.20	6.4	4.50	3.20	3.20	6.70	4.80	3.20
8-291K-045	M30	12.0	24	4.50	9.0	6.30	4.50	4.50	9.40	6.70	4.50
8-291K-070	M36	16.0	32	7.00	14.0	9.80	7.00	7.00	14.70	10.50	7.00
8-291K-090	M42	24.0	48	9.00	18.0	12.60	9.00	9.00	18.90	13.50	9.00
8-291K-120	M48	32.0	64	12.00	24.0	16.80	12.00	12.00	25.20	18.00	12.00
8-291K-140	M56	34.0	68	16.00	32.0	22.40	16.00	16.00	33.60	24.00	16.00
8-291K-150	M64	36.0	72	18.00	36.0	25.20	18.00	18.00	37.80	27.00	18.00

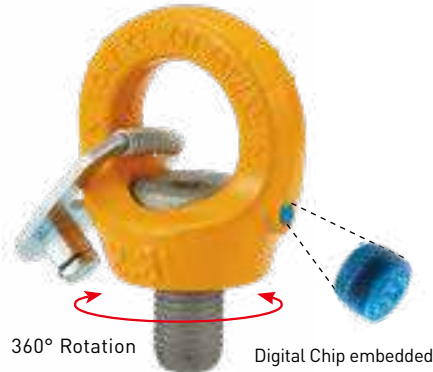
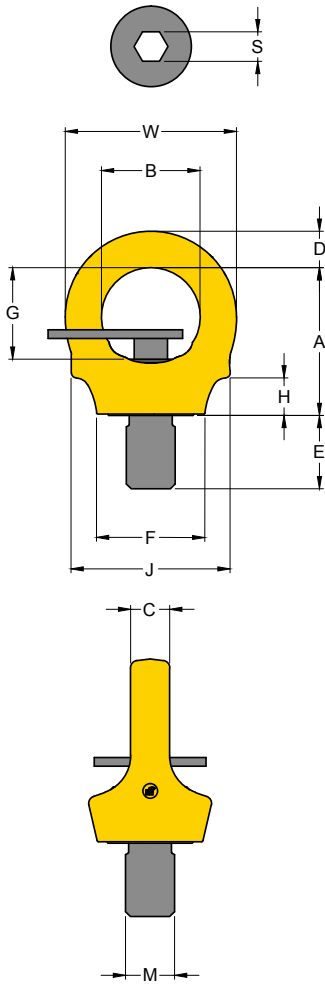

Digital Chip embedded with Certificate for serial Traceability

- Rotates through 360° adjustable in the direction of the load.
- Manufactured from alloy steel, quenched and tempered.
- Tested in accordance with EN1677-1.
- Load rated parts are 100% magnaflux crack detected.
- Individual forged parts and cap screw are traceable to Test Certification.
- Bolts are UNC thread.
- Proof tested to 2.5 times the WLL.
- Fatigue rated to 20,000 cycles at 1.5 times the WLL.
- All YOKE Lifting points meet or exceed all the requirements of ASME B30.26.
- Quick and simple assembly, just a tapped hole is required.

Allen Key Patent

- » United States Patent: 10259691
- » Germany Patent: 202018100296
- » China Patent: ZL201721542303.1
- » Taiwan Patent: 1644848

- » Mexico Patent: 3423
- » Japan Patent: 3192016
- » China Patent: ZL 2014 2 0228663.4

- » China Patent: ZL 2012 1 0131962.1
- » Taiwan Patent: 1468602

- » United States Patent: 10607128
- » UK Patent: 3627396
- » German Patent: 602018032891.2
- » Italy Patent: 3627396
- » Japan Patent: 3219858

Digital Key Eye Point

UNC Thread (8-292K)

Item No.	Working Load Limit	Thread version			Dimensions										Torque		N.W.
		M	E	TPI	A	B	C	D	F	G	H	J	S	W	in	lbs	
		tonnes	inch	inch													
8-292K-003	0.30	5/16	0.47	18UNC	1.49	1.00	0.33	0.37	0.99	0.92	0.24	1.60	0.25	1.73	10	0.3	
8-292K-004	0.40	3/8	0.56	16UNC	1.49	1.00	0.33	0.37	0.99	0.92	0.24	1.60	0.25	1.73	10	0.3	
8-292K-007	0.75	1/2	0.75	13UNC	1.79	1.19	0.39	0.43	1.30	1.16	0.37	1.85	0.31	2.05	10	0.5	
8-292K-015	1.50	5/8	0.94	11UNC	2.06	1.39	0.55	0.51	1.38	1.32	0.45	2.20	0.37	2.40	30	0.9	
8-292K-023	2.30	3/4	1.13	10UNC	2.38	1.59	0.63	0.58	1.74	1.47	0.60	2.56	0.5	2.76	70	1.4	
8-292K-025	2.30	7/8	1.31	9UNC	2.38	1.59	0.63	0.58	1.74	1.47	0.60	2.56	0.5	2.76	150	1.5	
8-292K-032	3.20	1	1.50	8UNC	2.85	1.91	0.75	0.70	2.08	1.79	0.75	3.07	0.56	3.31	150	2.5	
8-292K-045	4.50	1 1/4	1.88	7UNC	3.57	2.38	0.94	0.88	2.43	2.23	0.91	3.75	0.63	4.13	350	4.7	
8-292K-070	7.00	1 1/2	2.25	6UNC	4.32	2.85	1.14	1.05	2.99	2.71	1.20	4.49	0.87	4.96	410	8.7	
8-292K-090	9.00	1 3/4	2.63	5UNC	5.02	3.26	1.34	1.26	3.51	3.09	1.50	5.20	1.00	5.79	550	12.7	
8-292K-120	12.00	2	3.00	4.5UNC	5.70	3.74	1.50	1.44	4.12	3.69	1.75	5.91	1.00	6.61	550	19.6	

*Design Factor 4:1



Kind of attachment											
Number of legs	Thread	1	2	1	2	2	2	2	3-4	3-4	3-4
Load direction	Thread	0°	0°	90°	90°	0-45°	45°- 60°	unsymm.	0 - 45°	45°- 60°	unsymm.
Item No.	Inch	WLL(t)									
8-292K-003	5/16	1	2	0.30	0.6	0.42	0.30	0.30	0.63	0.45	0.30
8-292K-004	3/8	1	2	0.40	0.8	0.56	0.40	0.40	0.84	0.60	0.40
8-292K-007	1/2	2	4	0.75	1.5	1.00	0.75	0.75	1.58	1.12	0.75
8-292K-015	5/8	4	8	1.50	3.0	2.10	1.50	1.50	3.15	2.25	1.50
8-292K-023	3/4	6	12	2.30	4.6	3.20	2.30	2.30	4.83	3.45	2.30
8-292K-025	7/8	6	12	2.30	4.6	3.20	2.30	2.30	4.83	3.45	2.30
8-292K-032	1	8	16	3.20	6.4	4.50	3.20	3.20	6.70	4.80	3.20
8-292K-045	1 1/4	12	24	4.50	9.0	6.30	4.50	4.50	9.40	6.70	4.50
8-292K-070	1 1/2	16	32	7.00	14.0	9.80	7.00	7.00	14.70	10.50	7.00
8-292K-090	1 3/4	24	48	9.00	18.0	12.60	9.00	9.00	18.90	13.50	9.00
8-292K-120	2	32	64	12.00	24.0	16.80	12.00	12.00	25.20	18.00	12.00

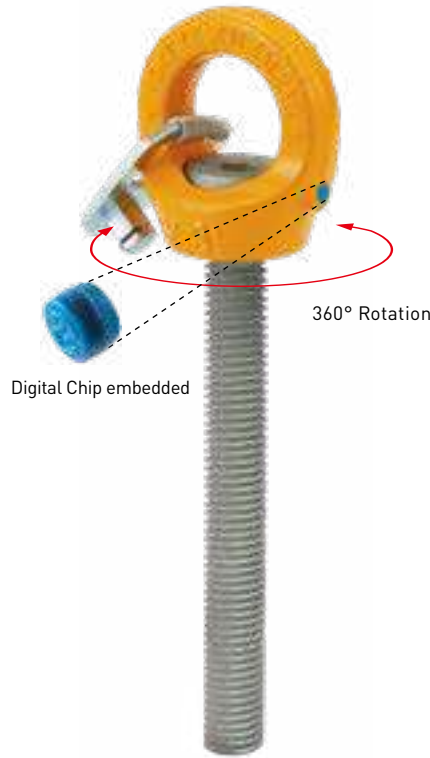
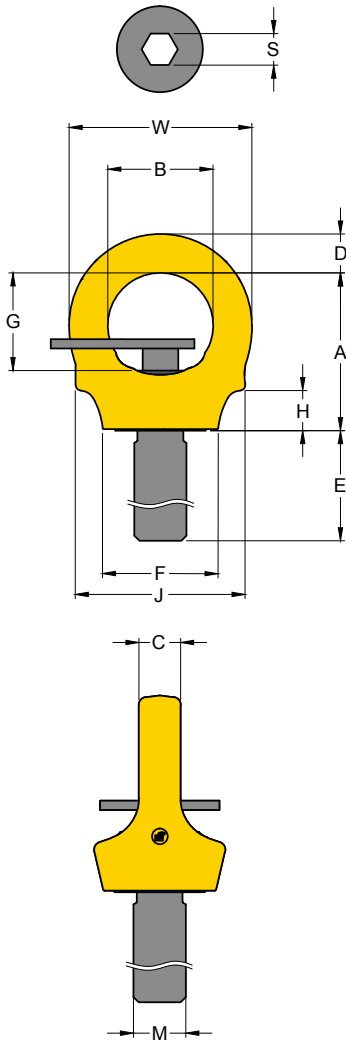

Digital Chip embedded with Certificate for serial Traceability

- Rotates through 360° adjustable in the direction of the load.
- Manufactured from alloy steel, quenched and tempered.
- Tested in accordance with EN1677-1.
- Load rated parts are 100% magnaflux crack detected.
- Individual forged parts and cap screw are traceable to Test Certification.
- Bolts are Metric thread.
- Proof tested to 2.5 times the WLL.
- Fatigue rated to 20,000 cycles at 1.5 times the WLL.
- All YOKE Lifting points meet or exceed all the requirements of ASME B30.26.
- Quick and simple assembly, just a tapped hole is required.

Allen Key Patent

- » United States Patent: 10259691
- » Germany Patent: 202018100296
- » China Patent: ZL201721542303.1
- » Taiwan Patent: 1644848

- » Mexico Patent: 3423
- » Japan Patent: 3192016
- » China Patent: ZL 2014 2 0228663.4

- » China Patent: ZL 2012 1 0131962.1
- » Taiwan Patent: 1648602

- » United States Patent: 10607128
- » UK Patent: 3627396
- » German Patent: 602018032891.2
- » Italy Patent: 3627396
- » Japan Patent: 3219858

Digital Key Eye Point, Long Bolt

Metric Thread (8-291KL)

NEW

Item No.	Working Load Limit	Thread version			Dimensions								Torque in Nm	N.W. kg		
		M	E	Pitch	A	B	C	D	F	G	H	J			S	W
	tonnes	mm	mm	DIN13												
8-291K-004/78L	0.40	M 10	70	1.50	38	25	9	9	25	24	6	41	6	44	10	0.2
8-291K-007/159L	0.75	M 12	150	1.75	45	30	10	11	33	30	9	47	8	52	10	0.3
8-291K-015/130L	1.50	M 16	120	2.00	52	35	14	13	35	34	11	56	10	61	30	0.6
8-291K-023/171L	2.30	M 20	160	2.50	60	40	16	15	44	37	15	65	12	70	70	0.9
8-291K-032/152L	3.20	M 24	140	3.00	72	49	19	18	53	47	19	78	14	84	150	1.5
8-291K-045/206L	4.50	M 30	190	3.50	91	61	24	22	62	59	23	95	17	105	350	2.9
8-291K-070/259L	7.00	M 36	240	4.00	110	73	29	27	76	72	31	114	22	126	410	5.2

* Design Factor 4:1



Kind of attachment											
Number of legs		1	2	1	2	2	2	2	3-4	3-4	3-4
Load direction		0°	0°	90°	90°	0-45°	45°- 60°	unsymm.	0 - 45°	45°- 60°	unsymm.
Item No.	Thread	WLL(t)									
8-291K-004/78L	M10	1	2	0.40	0.8	0.56	0.40	0.40	0.84	0.60	0.40
8-291K-007/159L	M12	2	4	0.75	1.5	1.05	0.75	0.75	1.58	1.12	0.75
8-291K-015/130L	M16	4	8	1.50	3.0	2.10	1.50	1.50	3.15	2.25	1.50
8-291K-023/171L	M20	6	12	2.30	4.6	3.20	2.30	2.30	4.83	3.45	2.30
8-291K-032/152L	M24	8	16	3.20	6.4	4.50	3.20	3.20	6.70	4.80	3.20
8-291K-045/206L	M30	12	24	4.50	9.0	6.30	4.50	4.50	9.40	6.70	4.50
8-291K-070/259L	M36	16	32	7.00	14.0	9.80	7.00	7.00	14.70	10.50	7.00

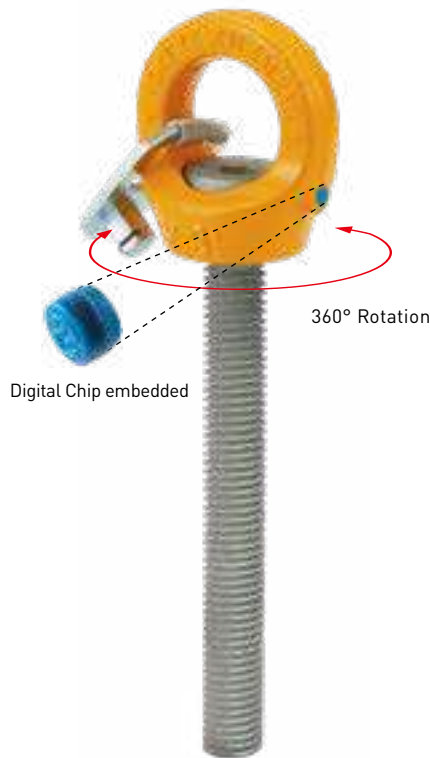
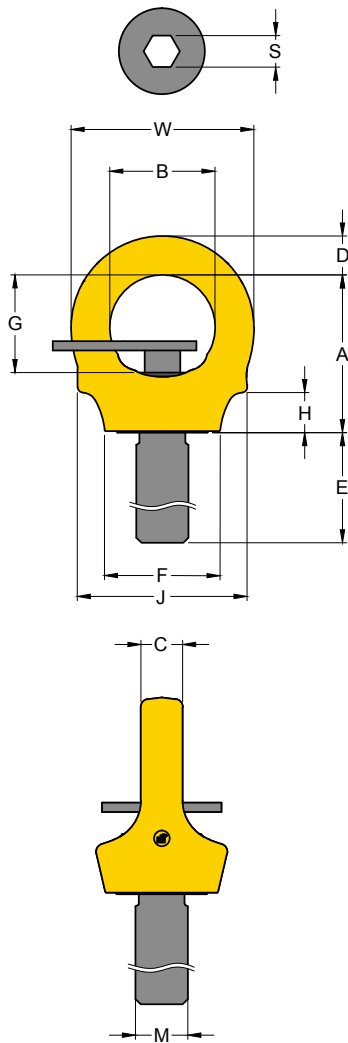

Digital Chip embedded with Certificate for serial Traceability

- Rotates through 360° adjustable in the direction of the load.
- Manufactured from alloy steel, quenched and tempered.
- Tested in accordance with EN1677-1.
- Load rated parts are 100% magnaflux crack detected.
- Individual forged parts and cap screw are traceable to Test Certification.
- Bolts are UNC thread.
- Proof tested to 2.5 times the WLL.
- Fatigue rated to 20,000 cycles at 1.5 times the WLL.
- All YOKE Lifting points meet or exceed all the requirements of ASME B30.26.
- Quick and simple assembly, just a tapped hole is required.

Allen Key Patent

- » United States Patent: 10259691
- » Germany Patent: 202018100296
- » China Patent: ZL201721542303.1
- » Taiwan Patent: 1644848

- » Mexico Patent: 3423
- » Japan Patent: 3192016
- » China Patent: ZL 2014 2 0228663.4

- » China Patent: ZL 2012 1 0131962.1
- » Taiwan Patent: 1468602

- » United States Patent: 10607128
- » UK Patent: 3627396
- » German Patent: 602018032891.2
- » Italy Patent: 3627396
- » Japan Patent: 3219858

Digital Key Eye Point, Long Bolt

UNC Thread (8-292KL)

NEW

Item No.	Working Load Limit	Thread version			Dimensions										Torque in		N.W.
		M	E	TPI	A	B	C	D	F	G	H	J	S	W	Nm	lbs	
		tonnes	inch	inch													
8-292K-007/157L	0.75	1/2	5.91	13UNC	1.79	1.19	0.39	0.43	1.30	1.16	0.37	1.85	0.31	2.05	10	0.8	
8-292K-015/129L	1.50	5/8	4.72	11UNC	2.06	1.39	0.55	0.51	1.38	1.32	0.45	2.20	0.37	2.40	30	1.2	
8-292K-023/172L	2.30	3/4	6.30	10UNC	2.38	1.59	0.63	0.58	1.74	1.47	0.60	2.56	0.5	2.76	70	2.1	
8-292K-032/156L	3.20	1	5.51	8UNC	2.85	1.91	0.75	0.70	2.08	1.79	0.75	3.07	0.56	3.31	150	3.3	
8-292K-045/208L	4.50	1 1/4	7.48	7UNC	3.57	2.38	0.94	0.88	2.43	2.23	0.91	3.75	0.63	4.13	350	6.5	

*Design Factor 4:1



Kind of attachment																		
	Number of legs	Thread	1	2	1	2	2	2	2	2	3-4	3-4	3-4	3-4	3-4	3-4	3-4	3-4
Load direction	Thread	0°	0°	90°	90°	0-45°	45°- 60°	unsymm.	0 - 45°	45°- 60°	unsymm.	0 - 45°	45°- 60°	unsymm.	0 - 45°	45°- 60°	unsymm.	0 - 45°
Item No.	Thread	WLL(t)																
8-292K-007/157L	1/2	2	4	0.75	1.5	1.05	0.75	0.75	1.58	1.12	0.75	1.58	1.12	0.75	1.58	1.12	0.75	1.58
8-292K-015/129L	5/8	4	8	1.50	3.0	2.10	1.50	1.50	3.15	2.25	1.50	3.15	2.25	1.50	3.15	2.25	1.50	3.15
8-292K-023/172L	3/4	6	12	2.30	4.6	3.20	2.30	2.30	4.83	3.45	2.30	4.83	3.45	2.30	4.83	3.45	2.30	4.83
8-292K-032/156L	1	8	16	3.20	6.4	4.50	3.20	3.20	6.70	4.80	3.20	6.70	4.80	3.20	6.70	4.80	3.20	6.70
8-292K-045/208L	1 1/4	12	24	4.50	9.0	6.30	4.50	4.50	9.40	6.70	4.50	9.40	6.70	4.50	9.40	6.70	4.50	9.40

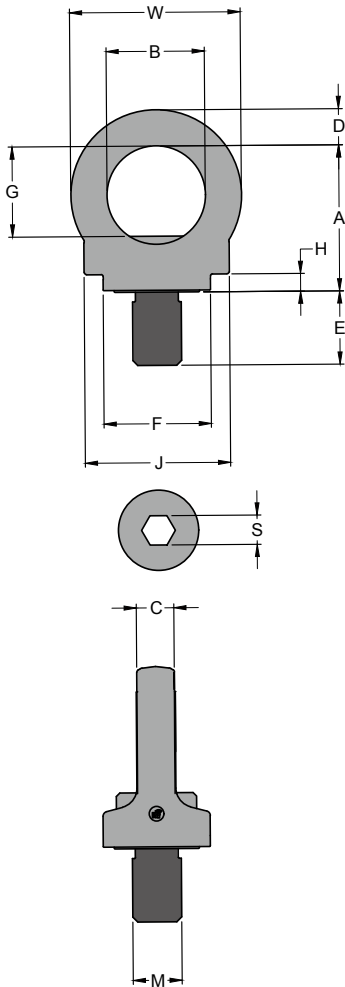

Digital Chip embedded with Certificate for serial Traceability

- Rotates through 360° adjustable in the direction of the load.
- Manufactured from stainless steel.
- Tested in accordance with EN1677-1.
- Individual forged parts and cap screw are traceable to Test Certification.
- Bolts are Metric thread.
- Proof tested to 2.5 times the WLL.
- Fatigue rated to 20,000 cycles at 1.5 times the WLL.
- All YOKE Lifting points meet or exceed all the requirements of ASME B30.26.
- Quick and simple assembly, just a tapped hole is required.
- Used in different applications such as chemical oil coal industries, food processing, clean room and precision instrument.

- » Mexico Patent: 3423
- » Japan Patent: 3192016
- » China Patent: ZL 2012 1 0131962.1/
ZL 2014 2 0228663.4
- » Taiwan Patent: I468602
- » United States Patent: 10607128
- » UK Patent: 3627396
- » German Patent: 602018032891.2
- » Italy Patent: 3627396
- » Japan Patent: 3219858

Digital Stainless Steel Eye Point Metric Thread (8-S291)

Item No.	Working Load Limit tonnes	Thread version			Dimensions										Torque in Nm	N.W. kg
		M	E	Pitch DIN13	A	B	C	D	F	G	H	J	S	W		
8-S291-005	0.5	M 12	18	1.75	45	30	10	11	33	29	5	44	8	52	10	0.2
8-S291-010	1.0	M 16	24	2.00	52	35	14	13	35	33	5	51	10	61	30	0.3
8-S291-020	2.0	M 20	30	2.50	60	40	16	15	44	37	7	60	12	70	70	0.6
8-S291-025	2.5	M 24	36	3.00	72	49	19	18	52	46	10	72	14	84	150	1.0

* Design Factor 4:1



Kind of attachment											
Number of legs		1	2	1	2	2	2	2	3-4	3-4	3-4
Load direction		0°	0°	90°	90°	0-45°	45°- 60°	unsymm.	0 - 45°	45°- 60°	unsymm.
Item No.	Thread	WLL(t)									
8-S291-005	M12	1.2	2.4	0.5	1	0.7	0.5	0.5	1.00	0.75	0.5
8-S291-010	M16	2.4	4.8	1.0	2	1.4	1.0	1.0	2.10	1.50	1.0
8-S291-020	M20	3.6	7.2	2.0	4	2.8	2.0	2.0	4.20	3.00	2.0
8-S291-025	M24	5.2	10.4	2.5	5	3.5	2.5	2.5	5.25	3.75	2.5

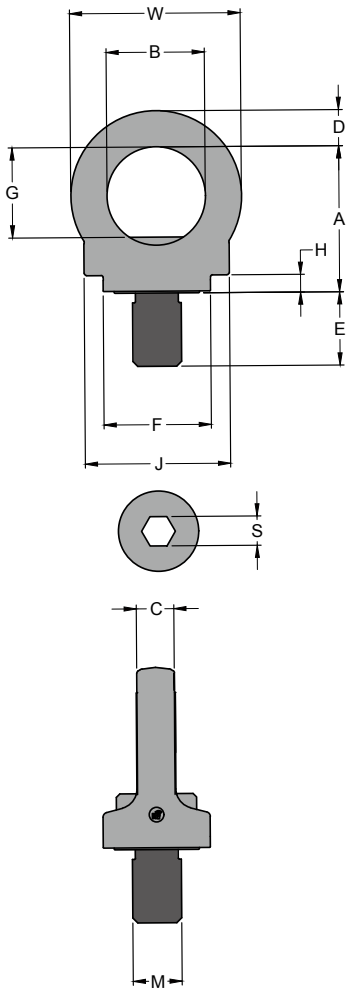

Digital Chip embedded with Certificate for serial Traceability

- Rotates through 360° adjustable in the direction of the load.
- Manufactured from stainless steel.
- Tested in accordance with EN1677-1.
- Individual forged parts and cap screw are traceable to Test Certification.
- Bolts are UNC thread.
- Proof tested to 2.5 times the WLL.
- Fatigue rated to 20,000 cycles at 1.5 times the WLL.
- All YOKE Lifting points meet or exceed all the requirements of ASME B30.26.
- Quick and simple assembly, just a tapped hole is required.
- Used in different applications such as chemical oil coal industries, food processing, clean room and precision instrument.

- » Mexico Patent: 3423
- » Japan Patent: 3192016
- » China Patent: ZL 2012 1 0131962.1/
ZL 2014 2 0228663.4
- » Taiwan Patent: I468602
- » United States Patent: 10607128
- » UK Patent: 3627396
- » German Patent: 602018032891.2
- » Italy Patent: 3627396
- » Japan Patent: 3219858

Digital Stainless Steel Eye Point

UNC Thread (8-S292)

Item No.	Working Load Limit	Thread version			Dimensions										Torque		N.W.	
		M	E	TPI	A	B	C	D	F	G	H	J	S	W	in	Nm		lbs
	tonnes	inch	inch															
8-S292-005	0.5	1/2	0.75	13UNC	1.77	1.18	0.39	0.43	1.30	1.14	0.20	1.73	0.31	0.31	10	0.4		
8-S292-010	1.0	5/8	0.94	11UNC	2.05	1.38	0.55	0.51	1.38	1.30	0.20	2.01	0.39	0.39	30	0.7		
8-S292-020	2.0	3/4	1.40	10UNC	2.36	1.57	0.63	0.59	1.73	1.46	0.28	2.36	0.47	0.47	70	1.3		
8-S292-025	2.5	1	1.52	8UNC	2.83	1.93	0.75	0.71	2.05	1.81	0.39	2.83	0.55	0.55	150	2.2		

* Design Factor 4:1



Kind of attachment											
Number of legs	Thread	1	2	1	2	2	2	2	3-4	3-4	3-4
Load direction	Thread	0°	0°	90°	90°	0-45°	45°- 60°	unsymm.	0 - 45°	45°- 60°	unsymm.
Item No.	Inch	WLL(t)									
8-S292-005	1/2	1.2	2.4	0.5	1	0.7	0.5	0.5	1.00	0.75	0.5
8-S292-010	5/8	2.4	4.8	1.0	2	1.4	1.0	1.0	2.10	1.50	1.0
8-S292-020	3/4	3.6	7.2	2.0	4	2.8	2.0	2.0	4.20	3.00	2.0
8-S292-025	1	5.2	10.4	2.5	5	3.5	2.5	2.5	5.25	3.75	2.5

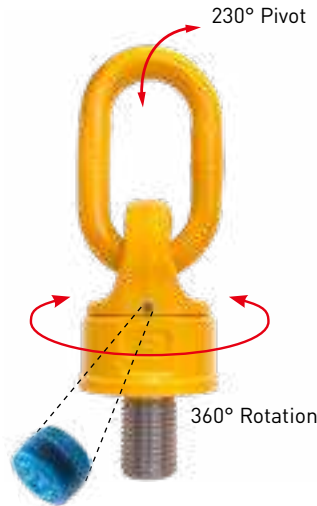
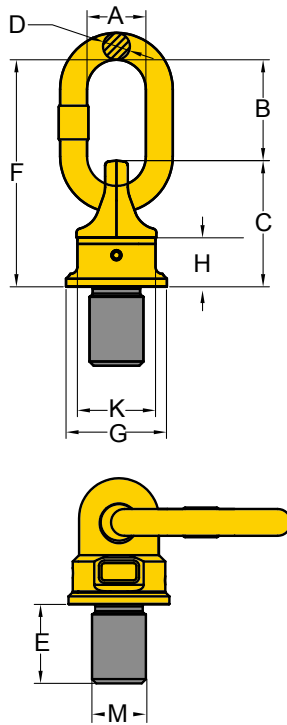

Digital Chip embedded



Ball Bearing Inside

Digital Chip embedded with Certificate for serial Traceability

- Pivots to 230°, rotates through 360° due to its unique ball bearing design.
- Manufactured from forged alloy steel, quenched and tempered.
- Tested in accordance with EN1677-4.
- Certified by DGVV GS-0A-15-04.
- Load rated parts are 100% magnaflux crack detected.
- Individual forged parts and batch code links to Test Certificate sheet.
- Bolts are Metric thread.
- Proof tested to 2.5 times the WLL.
- Fatigue rated to 20,000 cycles at 1.5 times the WLL.
- All YOKE Lifting points meet or exceed all the requirements of ASME B30.26.
- Easy to attach or dismantle due to the forged hexagon shaped body of the Swivel Point.
- Capable of rotating under load. Do not turn continuously in 90 degree direction at full load.

- » United States Patent: 10607128
- » UK Patent: 3627396
- » German Patent: 602018032891.2
- » Italy Patent: 3627396
- » Japan Patent: 3219858

Digital Swivel Point

Metric Thread (8-271)

Item No.	Working Load Limit tonnes	Thread version			Dimensions (mm)								Torque in		N.W. kg
		M mm	E mm	Pitch DIN13	G	C	K	H	F	D	B	A	Nm		
8-271-003	0.4	M 8	12	1.25	35	40	30	16	72	8	32	29	10	0.2	
8-271-004	0.6	M 10	15	1.50	35	40	30	16	72	8	32	29	10	0.2	
8-271-006	0.7	M 12	18	1.75	40	45	36	18	95	10	50	35	10	0.3	
8-271-013	1.5	M 16	24	2.00	46	54	41	22	104	13	50	36	30	0.5	
8-271-020	2.5	M 20	30	2.50	62	68	55	29	122	13	54	36	70	1.0	
8-271-035	4.0	M 24	36	3.00	78	88	70	36	154	19	66	41	150	2.2	
8-271-060	6.0	M 30	45	3.50	90	120	80	48	206	22	86	50	350	4.5	
8-271-067	6.7	M 30	45	3.50	90	120	80	48	206	22	86	50	350	4.5	
8-271-080	10.0	M 36	54	4.00	90	120	80	48	206	22	86	50	410	4.6	
8-271-120	13.0	M 42	63	4.50	98	122	84	50	235	25	110	67	550	5.5	
8-271-130	14.0	M 48	72	5.00	98	122	84	50	235	25	110	67	550	6.1	
8-271-140	20.0	M 52	78	5.00	120	150	94	60	270	32	120	72	750	10.5	
8-271-160	20.0	M 56	84	5.50	120	150	94	60	270	32	120	72	800	10.7	
8-271-161	20.0	M 64	96	6.00	120	150	94	60	270	32	120	72	800	11.6	
8-271-310	40.0	M 72	108	6.00	170	210	145	83	340	45	130	90	1200	30.6	
8-271-350	40.0	M 80	120	6.00	170	210	145	83	340	45	130	90	1500	31.6	
8-271-400	40.0	M 90	135	6.00	170	210	145	83	340	45	130	90	2000	33.9	

* Design Factor 4:1



Kind of attachment											
Number of legs		1	2	1	2	2	2	2	3-4	3-4	3-4
Load direction		0°	0°	90°	90°	0-45°	45°- 60°	unsymm.	0 - 45°	45°- 60°	unsymm.
Item No.	Thread	WLL(t)									
8-271-003	M 8	0.6	1.2	0.4	0.8	0.56	0.4	0.4	0.84	0.60	0.4
8-271-004	M10	0.9	1.8	0.6	1.2	0.84	0.6	0.6	1.26	0.90	0.6
8-271-006	M12	1.2	2.4	0.7	1.4	0.98	0.7	0.7	1.47	1.05	0.7
8-271-013	M16	2.6	5.2	1.5	3.0	2.10	1.5	1.5	3.15	2.25	1.5
8-271-020	M20	4.0	8.0	2.5	5.0	3.50	2.5	2.5	5.25	3.75	2.5
8-271-035	M24	7.0	14.0	4.0	8.0	5.60	4.0	4.0	8.40	6.00	4.0
8-271-060	M30	10.0	20.0	6.0	12.0	8.40	6.0	6.0	12.60	9.00	6.0
8-271-067	M30	12.0	24.0	6.7	13.4	9.40	6.7	6.7	14.10	10.00	6.7
8-271-080	M36	15.0	30.0	10.0	20.0	14.00	10.0	10.0	21.00	15.00	10.0
8-271-120	M42	17.0	34.0	13.0	26.0	18.20	13.0	13.0	27.30	19.50	13.0
8-271-130	M48	18.0	36.0	14.0	28.0	19.60	14.0	14.0	29.40	21.00	14.0
8-271-140	M52	25.0	50.0	20.0	40.0	28.00	20.0	20.0	42.00	30.00	20.0
8-271-160	M56	28.0	56.0	20.0	40.0	28.00	20.0	20.0	42.00	30.00	20.0
8-271-161	M64	28.0	56.0	20.0	40.0	28.00	20.0	20.0	42.00	30.00	20.0
8-271-310	M72	50.0	100.0	40.0	80.0	56.00	40.0	40.0	84.00	60.00	40.0
8-271-350	M80	50.0	100.0	40.0	80.0	56.00	40.0	40.0	84.00	60.00	40.0
8-271-400	M90	50.0	100.0	40.0	80.0	56.00	40.0	40.0	84.00	60.00	40.0

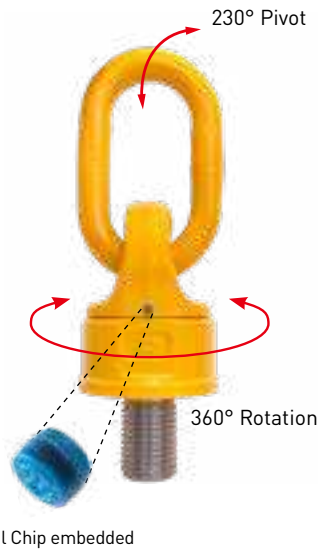
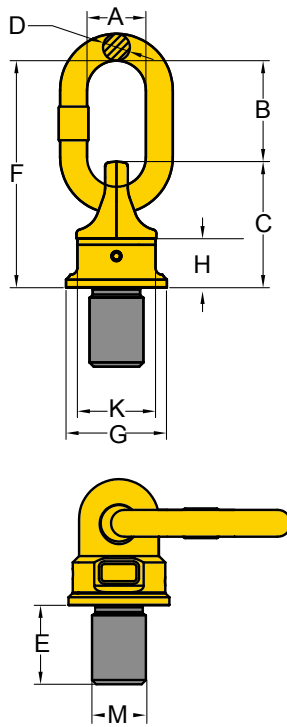

- Pivots to 230°, rotates through 360° due to its unique ball bearing design.
- Manufactured from forged alloy steel, quenched and tempered.
- Tested in accordance with EN1677-4.
- Load rated parts are 100% magnaflux crack detected.
- Individual forged parts and batch code links to Test Certificate sheet.
- Bolts are UNC thread.
- Proof tested to 2.5 times the WLL.
- Fatigue rated to 20,000 cycles at 1.5 times the WLL.
- All YOKE Lifting points meet or exceed all the requirements of ASME B30.26.
- Easy to attach or dismantle due to the forged hexagon shaped body of the Swivel Point.
- Capable of rotating under load. Do not turn continuously in 90 degree direction at full load.



Ball Bearing Inside

Digital Chip embedded with Certificate for serial Traceability

- » United States Patent: 10607128
- » UK Patent: 3627396
- » German Patent: 602018032891.2
- » Italy Patent: 3627396
- » Japan Patent: 3219858

Digital Swivel Point

UNC Thread (8-272)

Item No.	Working Load Limit	Thread version			Dimensions									Torque	
		M	E	TPI	G	C	K	H	F	D	B	A	in	N.W.	
		tonnes	inch	inch					inch					Nm	lbs
8-272-006	0.7	1/2	0.75	13UNC	1.57	1.77	1.42	0.71	3.74	0.39	1.97	1.38	15	0.7	
8-272-013	1.5	5/8	0.94	11UNC	1.81	2.13	1.61	0.87	4.09	0.51	1.97	1.42	45	1.2	
8-272-018	2.0	3/4	1.13	10UNC	1.81	2.68	1.61	0.87	4.09	0.51	1.97	1.42	45	1.2	
8-272-020	2.5	7/8	1.31	9UNC	2.44	2.68	2.17	1.14	4.80	0.51	2.13	1.42	100	2.2	
8-272-035	4.0	1	1.50	8UNC	3.07	3.46	2.76	1.42	6.06	0.75	2.60	1.61	190	4.8	
8-272-060	6.0	1 1/4	1.88	7UNC	3.54	4.72	3.15	1.89	8.11	0.87	3.39	1.97	270	9.9	
8-272-080	10.0	1 1/2	2.25	6UNC	3.54	4.72	3.15	1.89	8.11	0.87	3.39	1.97	270	10.0	
8-272-120	13.0	1 3/4	2.63	5UNC	3.86	4.80	3.31	1.97	9.25	0.98	4.33	2.64	350	12.1	
8-272-130	14.0	2	3.00	4.5UNC	3.86	4.80	3.31	1.97	9.25	0.98	4.33	2.64	350	13.5	
8-272-140	20.0	2 1/4	3.38	4.5UNC	4.72	5.91	3.70	2.36	10.63	1.26	4.72	2.83	350	23.1	
8-272-160	20.0	2 1/2	3.75	4UNC	4.72	5.91	3.70	2.36	10.63	1.26	4.72	2.83	350	23.5	

* Design Factor 4:1
 * Please refer to 8-252 table for specification ≥ 3-4UNC.



Kind of attachment																		
	Number of legs	Load direction	Thread	WLL(t)	WLL(t)	WLL(t)	WLL(t)	WLL(t)	WLL(t)	WLL(t)	WLL(t)	WLL(t)	WLL(t)	WLL(t)	WLL(t)	WLL(t)	WLL(t)	WLL(t)
Item No.	Inch																	
8-272-006	1/2	1.2	2.4	0.7	1.4	0.98	0.7	0.7	1.47	1.05	0.7							
8-272-013	5/8	2.6	5.2	1.5	3.0	2.10	1.5	1.5	3.15	2.25	1.5							
8-272-018	3/4	3.6	7.2	2.0	4.0	2.80	2.0	2.0	4.20	3.00	2.0							
8-272-020	7/8	4.0	8.0	2.5	5.0	3.50	2.5	2.5	5.25	3.75	2.5							
8-272-035	1	7.0	14.0	4.0	8.0	5.60	4.0	4.0	8.40	6.00	4.0							
8-272-060	1 1/4	10.0	20.0	6.0	12.0	8.40	6.0	6.0	12.60	9.00	6.0							
8-272-080	1 1/2	15.0	30.0	10.0	20.0	14.00	10.0	10.0	21.00	15.00	10.0							
8-272-120	1 3/4	17.0	34.0	13.0	26.0	18.20	13.0	13.0	27.30	19.50	13.0							
8-272-130	2	18.0	36.0	14.0	28.0	19.60	14.0	14.0	29.40	21.00	14.0							
8-272-140	2 1/4	25.0	50.0	20.0	40.0	28.00	20.0	20.0	42.00	30.00	20.0							
8-272-160	2 1/2	28.0	56.0	20.0	40.0	28.00	20.0	20.0	42.00	30.00	20.0							

* Please refer to 8-252 table for specification \geq 3-4UNC.

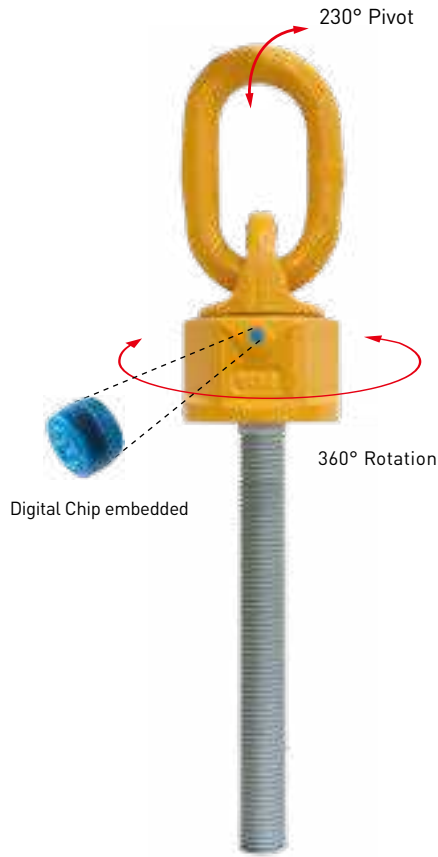
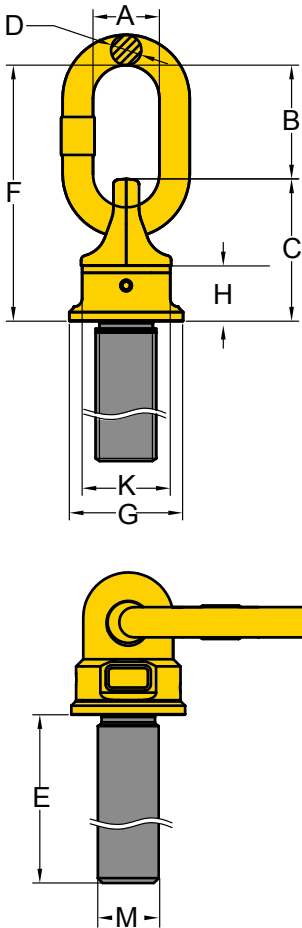

- Pivots to 230°, rotates through 360° due to its unique ball bearing design.
- Manufactured from forged alloy steel, quenched and tempered.
- Tested in accordance with EN1677-4.
- Load rated parts are 100% magnaflux crack detected.
- Individual forged parts and batch code links to Test Certificate sheet.
- Bolts are Metric thread.
- Proof tested to 2.5 times the WLL.
- Fatigue rated to 20,000 cycles at 1.5 times the WLL.
- All YOKE Lifting points meet or exceed all the requirements of ASME B30.26.
- Easy to attach or dismantle due to the forged hexagon shaped body of the Swivel Point.
- Capable of rotating under load. Do not turn continuously in 90 degree direction at full load.

- » United States Patent: 10607128
- » UK Patent: 3627396
- » German Patent: 602018032891.2
- » Italy Patent: 3627396
- » Japan Patent: 3219858

Digital Swivel Point, Long Bolt

Metric Thread (8-273)

NEW

Digital Chip embedded with Certificate for serial Traceability

Item No.	Working Load Limit	Thread version			Dimensions (mm)							Torque		N.W.
		M	E	Pitch	G	C	K	H	F	D	B	A	Nm	
	tonnes	mm	mm	DIN13				mm						
8-273-003/108L	0.30	M 8	102	1.25	35	47.5	30	23.5	79.5	8	32	29	10 - 40	0.5
8-273-004/128L	0.45	M 10	122	1.50	35	47.5	30	23.5	79.5	8	32	29	10 - 40	0.5
8-273-006/145L	0.60	M 12	140	1.75	40	55.0	36	28.0	105.0	10	50	35	15 - 40	0.8
8-273-013/186L	1.30	M 16	180	2.00	46	66.0	41	34.0	116.0	13	50	36	45 - 130	1.2
8-273-020/235L	2.00	M 20	223	2.50	62	83.0	55	44.0	137.0	13	54	36	100 - 170	2.0
8-273-035/267L	3.50	M 24	257	3.00	78	105.0	70	53.0	171.0	19	66	41	190 - 280	3.5
8-273-050/346L	5.00	M 30	330	3.50	90	141.0	80	69.0	227.0	22	86	50	270 - 600	6.8

* Design Factor 4:1



Kind of attachment																
	Number of legs	Load direction	1	2	1	2	2	2	2	2	3-4	3-4	3-4	3-4	3-4	3-4
Item No.	Thread	WLL(t)														
8-273-003/108L	M 8	0.6	1.2	0.30	0.6	0.42	0.30	0.30	0.63	0.45	0.30	0.95	0.68	0.45	0.30	
8-273-004/128L	M10	0.9	1.8	0.45	0.9	0.63	0.45	0.45	0.95	0.68	0.45	1.26	0.90	0.60	0.45	
8-273-006/145L	M12	1.2	2.4	0.60	1.2	0.84	0.60	0.60	1.26	0.90	0.60	1.68	1.26	0.90	0.60	
8-273-013/186L	M16	2.6	5.2	1.30	2.6	1.82	1.30	1.30	2.73	1.95	1.30	3.64	2.73	1.95	1.30	
8-273-020/235L	M20	4.0	8.0	2.00	4.0	2.80	2.00	2.00	4.20	3.00	2.00	5.60	4.20	3.00	2.00	
8-273-035/267L	M24	7.0	14.0	3.50	7.0	4.90	3.50	3.50	7.35	5.25	3.50	10.50	7.35	5.25	3.50	
8-273-050/346L	M30	10.0	20.0	5.00	10.0	7.00	5.00	5.00	10.50	7.50	5.00	15.75	10.50	7.50	5.00	

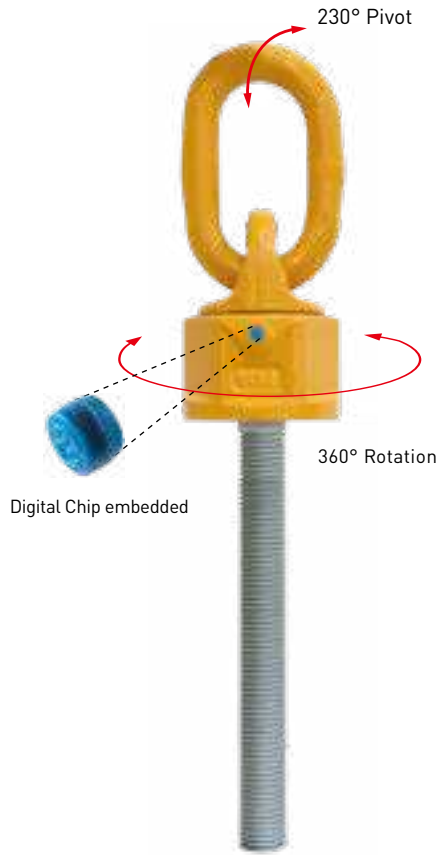
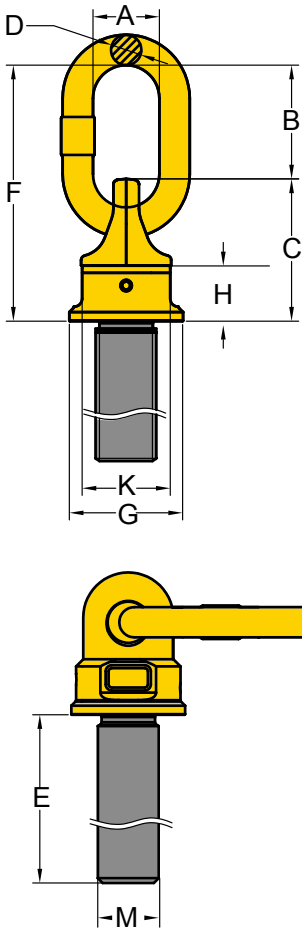

- Pivots to 230°, rotates through 360° due to its unique ball bearing design.
- Manufactured from forged alloy steel, quenched and tempered.
- Tested in accordance with EN1677-4.
- Load rated parts are 100% magnaflux crack detected.
- Individual forged parts and batch code links to Test Certificate sheet.
- Bolts are UNC thread.
- Proof tested to 2.5 times the WLL.
- Fatigue rated to 20,000 cycles at 1.5 times the WLL.
- All YOKE Lifting points meet or exceed all the requirements of ASME B30.26.
- Easy to attach or dismantle due to the forged hexagon shaped body of the Swivel Point.
- Capable of rotating under load. Do not turn continuously in 90 degree direction at full load.

- » United States Patent: 10607128
- » UK Patent: 3627396
- » German Patent: 602018032891.2
- » Italy Patent: 3627396
- » Japan Patent: 3219858

Digital Swivel Point, Long Bolt

UNC Thread (8-274)

NEW

Digital Chip embedded with Certificate for serial Traceability

Item No.	Working Load Limit	Thread version			Dimensions							Torque		N.W.	
		M	E	TPI	G	C	K	H	F	D	B	A	in		
	tonnes	inch	inch					inch						Nm	lbs
8-274-006/154L	0.6	1/2	5.87	13UNC	1.57	2.17	1.42	1.10	4.13	0.39	1.97	1.38		15 - 40	0.9
8-274-013/186L	1.3	5/8	7.09	11UNC	1.81	2.60	1.61	1.34	4.57	0.51	1.97	1.42		45 - 130	1.7
8-274-018/234L	2.0	3/4	8.74	10UNC	2.44	3.25	2.17	1.71	5.37	0.51	2.13	1.42		45 - 130	2.3
8-274-035/256L	3.5	1	9.69	8UNC	3.07	4.13	2.76	2.09	6.73	0.75	2.60	1.61		190 - 280	6.5
8-274-050/247L	5.0	1 1/4	13.03	7UNC	3.54	5.55	3.15	2.72	8.94	0.87	3.39	1.97		270 - 600	13.4

* Design Factor 4:1
 * Please refer to 8-252 table for specification \geq 3-4UNC.



Kind of attachment																
	1	2	1	2	2	2	2	3-4	3-4	3-4	3-4	3-4	3-4	3-4	3-4	
Number of legs	1	2	1	2	2	2	2	3-4	3-4	3-4	3-4	3-4	3-4	3-4	3-4	
Load direction	0°	0°	90°	90°	0-45°	45°-60°	unsymm.	0-45°	45°-60°	unsymm.	0-45°	45°-60°	unsymm.	0-45°	45°-60°	
Item No.	Thread	WLL(t)														
8-274-006/154L	1/2	1.2	2.4	0.6	1.2	0.84	0.6	0.6	1.26	0.90	0.6	1.26	0.90	0.6	1.26	
8-274-013/186L	5/8	2.6	5.2	1.3	2.6	1.82	1.3	1.3	2.73	1.95	1.3	2.73	1.95	1.3	2.73	
8-274-018/234L	3/4	3.6	7.2	2.0	4.0	2.80	2.0	2.0	4.20	3.00	2.0	4.20	3.00	2.0	4.20	
8-274-035/256L	1	7.0	14.0	3.5	7.0	4.90	3.5	3.5	7.35	5.25	3.5	7.35	5.25	3.5	7.35	
8-274-050/247L	1 1/4	10.0	20.0	5.0	10.0	7.00	5.0	5.0	10.50	7.50	5.0	10.50	7.50	5.0	10.50	

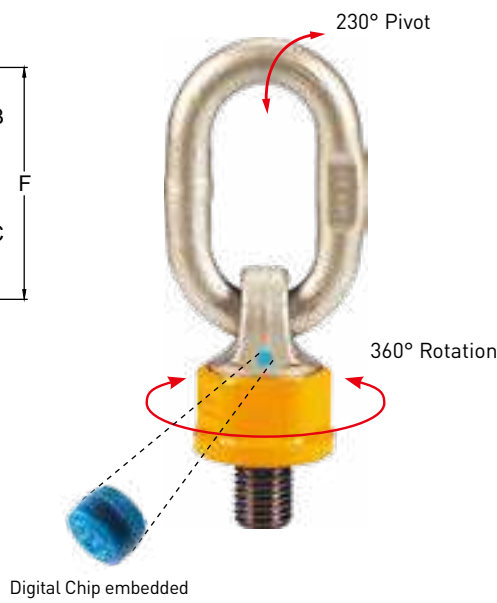
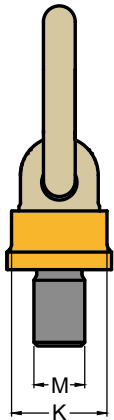
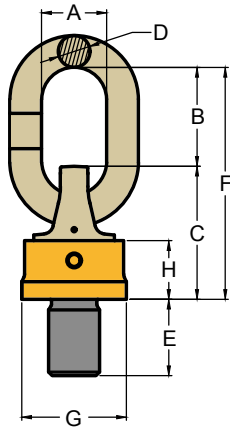

Digital Chip embedded with Certificate for serial Traceability

- Pivots to 230°, rotates through 360° due to its unique ball bearing design.
- Manufactured from forged alloy steel, quenched and tempered.
- Tested in accordance with EN1677-4.
- All YOKE Lifting points meet or Certified by DGUV GS-0A-15-04.
- Load rated parts are 100% magnaflux crack detected.
- Individual forged parts and batch code links to Test Certificate sheet.
- Bolts are Metric thread.
- Proof tested to 2.5 times the WLL.
- Fatigue rated to 20,000 cycles at 1.5 times the WLL.
- All YOKE Lifting points meet or exceed all the requirements of ASME B30.26.
- Easy to attach or dismantle due to the forged hexagon shaped body of the Super Point
- Capable of rotating under load. Do not turn continuously in 90 degree direction at full load.
- With the new WLL tables you can find the right Super Point attachment for your application and by the yellow marking on both sides you can measure disposal stage of the Super Point.

- » United States Patent: 10607128
- » UK Patent: 3627396
- » German Patent: 602018032891.2
- » Italy Patent: 3627396
- » Japan Patent: 3219858

Digital Super Point

Metric Thread (8-251)

Digital Super Point

UNC Thread (8-252)

* Design Factor 4:1



Kind of attachment											
Number of legs		1	2	1	2	2	2	2	3-4	3-4	3-4
Load direction		0°	0°	90°	90°	0-45°	45°- 60°	unsymm.	0 - 45°	45° - 60°	unsymm.
Item No.	Thread	WLL(t)									
8-251-004	M8	0.6	1.2	0.3	0.6	0.40	0.3	0.3	0.60	0.45	0.3
	M10	1.0	2.0	0.5	1.0	0.70	0.5	0.5	1.00	0.75	0.5
8-251-007	M12	1.4	2.8	0.7	1.4	1.00	0.7	0.7	1.40	1.00	0.7
	M14	2.0	4.0	1.0	2.0	1.40	1.0	1.0	2.12	1.50	1.0
8-251-014	M16	2.8	5.6	1.4	2.8	2.00	1.4	1.4	3.00	2.12	1.4
	M20	3.4	6.8	1.7	3.4	2.40	1.7	1.7	3.55	2.50	1.7
	M24	3.4	6.8	1.7	3.4	2.40	1.7	1.7	3.55	2.50	1.7
8-251-025	M20	5.0	10.0	2.5	5.0	3.55	2.5	2.5	5.30	3.75	2.5
8-251-040	M24	8.0	16.0	4.0	8.0	5.60	4.0	4.0	8.50	6.00	4.0
	M30	8.0	16.0	4.0	8.0	5.60	4.0	4.0	8.50	6.00	4.0
8-251-067	M30	12.0	24.0	6.7	13.4	9.50	6.7	6.7	14.00	10.00	6.7
8-251-080	M30	12.0	24.0	8.0	16.0	11.20	8.0	8.0	16.00	12.00	8.0
8-251-100	M36	15.0	30.0	10.0	20.0	14.00	10.0	10.0	21.20	15.00	10.0
8-251-125	M42	15.0	30.0	12.5	25.0	17.00	12.5	12.5	25.00	18.00	12.5
	M45	15.0	30.0	12.5	25.0	17.00	12.5	12.5	25.00	18.00	12.5
	M48	15.0	30.0	12.5	25.0	17.00	12.5	12.5	25.00	18.00	12.5
8-251-170	M42	20.0	40.0	13.0	26.0	18.00	13.0	13.0	27.00	19.00	13.0
	M45	25.0	50.0	17.0	34.0	23.50	17.0	17.0	35.00	25.00	17.0
	M48	25.0	50.0	17.0	34.0	23.50	17.0	17.0	35.00	25.00	17.0
	M52	25.0	50.0	17.0	34.0	23.50	17.0	17.0	35.00	25.00	17.0
	M56	25.0	50.0	18.0	36.0	25.00	18.0	18.0	37.50	26.50	18.0
8-251-200	M64	25.0	50.0	20.0	40.0	28.00	20.0	20.0	42.50	30.00	20.0
8-251-280	M64	32.5	65.0	28.0	56.0	39.00	28.0	28.0	58.00	42.00	28.0
	M72	32.5	65.0	28.0	56.0	39.00	28.0	28.0	58.00	42.00	28.0
	M80	32.5	65.0	28.0	56.0	39.00	28.0	28.0	58.00	42.00	28.0
8-251-350	M72	40.0	80.0	35.0	70.0	49.00	35.0	35.0	74.00	52.50	35.0
	M80	40.0	80.0	35.0	70.0	49.00	35.0	35.0	74.00	52.50	35.0
	M90	40.0	80.0	35.0	70.0	49.00	35.0	35.0	74.00	52.50	35.0
8-251-400	M72	50.0	100.0	40.0	80.0	56.00	40.0	40.0	84.00	60.00	40.0
	M80	50.0	100.0	40.0	80.0	56.00	40.0	40.0	84.00	60.00	40.0
	M90	50.0	100.0	40.0	80.0	56.00	40.0	40.0	84.00	60.00	40.0
	M100	50.0	100.0	40.0	80.0	56.00	40.0	40.0	84.00	60.00	40.0

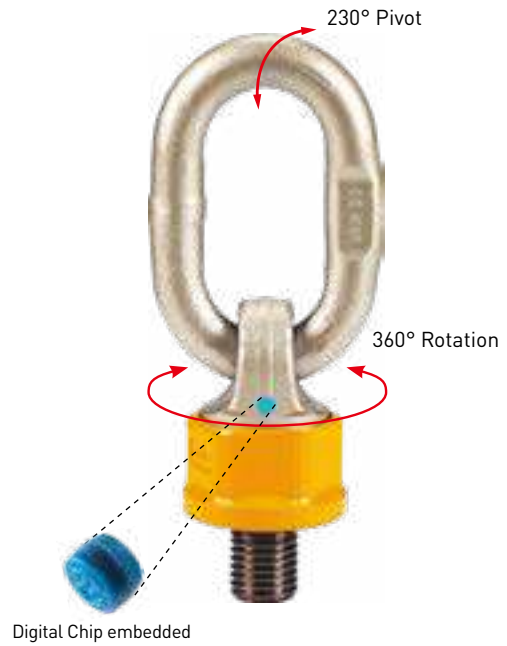
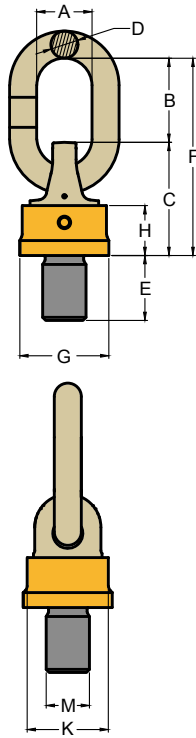

Digital Chip embedded with Certificate for serial Traceability

Digital Super Point

Metric Thread (8-251)

Item No.	Working Load Limit tonnes	Thread version			Dimensions							Torque in Nm	N.W. kg	
		M mm	E mm	Pitch DIN13	G	C	K	H	F	D	B			A
8-251-004-01	0.3	M8	12	1.25	36.5	48	34	20.5	101	13	53	35	10 - 40	0.3
8-251-007-02	0.7	M12	18	1.75	36.5	48	34	20.5	101	13	53	35	15 - 40	0.4
8-251-014-02	1.4	M16	24	2.00	36.5	48	34	20.5	101	13	53	35	45 - 130	0.5
8-251-014-04	1.7	M20	30	2.50	36.5	48	34	20.5	101	13	53	35	75 - 130	0.5
8-251-025-01	2.5	M20	30	2.50	52.0	68	46	28.0	127	16	59	35	100 - 170	1.0
8-251-040-02	4.0	M24	36	3.00	57.0	75	50	34.5	148	19	73	40	190 - 280	1.5
8-251-067-02	6.7	M30	45	3.50	70.0	95	65	41.0	163	20	68	40	230 - 400	2.4
8-251-080-02	8.0	M30	45	3.50	81.0	106	75	48.0	201	22	95	50	270 - 600	3.7
8-251-100-02	10.0	M36	54	4.00	81.0	106	75	48.0	201	22	95	50	270 - 600	3.9
8-251-125-03	12.5	M42	63	4.50	81.0	106	75	48.0	201	22	95	50	270 - 700	4.0
8-251-125-05	12.5	M48	72	5.00	81.0	106	75	48.0	201	22	95	50	270 - 700	4.4
8-251-170-04	17.0	M48	72	5.00	104.0	127	95	58.0	256	32	129	70	350 - 800	7.7

* Design Factor 4:1

for Size Quick View

Item No.	Working Load Limit	Thread version				Dimensions							Torque in	N.W.
		y tonnes	M inch	E mm	Pitch DIN13	G	C	K	H mm	F	D	B	A	Nm
8-251-004-01	0.3	M8	12	1.25	36.5	48	34	20.5	101	13	53	35	10 - 40	0.3
8-251-007-01	0.5	M10	18	1.50	36.5	48	34	20.5	101	13	53	35	10 - 40	0.4
8-251-007-02	0.7	M12	18	1.75	36.5	48	34	20.5	101	13	53	35	15 - 40	0.4
8-251-007-03	0.7	M12	25	1.75	36.5	48	34	20.5	101	13	53	35	15 - 40	0.4
8-251-007-04	1.0	M14	20	2.00	36.5	48	34	20.5	101	13	53	35	30 - 40	0.4
8-251-014-01	1.4	M16	20	2.00	36.5	48	34	20.5	101	13	53	35	45 - 130	0.44
8-251-014-02	1.4	M16	24	2.00	36.5	48	34	20.5	101	13	53	35	45 - 130	0.5
8-251-014-03	1.4	M16	30	2.00	36.5	48	34	20.5	101	13	53	35	45 - 130	0.5
8-251-014-04	1.7	M20	30	2.50	36.5	48	34	20.5	101	13	53	35	75 - 130	0.5
8-251-014-05	1.7	M24	30	3.00	36.5	48	34	20.5	101	13	53	35	90 - 130	0.5
8-251-025-01	2.5	M20	30	2.50	52	68	46	28	127	16	59	35	100 - 170	1.0
8-251-025-02	2.5	M20	40	2.50	52	68	46	28	127	16	59	35	100 - 170	1.0
8-251-025-03	2.5	M20	50	2.50	52	68	46	28	127	16	59	35	100 - 170	1.1
8-251-025-04	2.5	M20	70	2.50	52	68	46	28	127	16	59	35	100 - 170	1.1
8-251-040-01	4.0	M24	30	3.00	57	75	50	34.5	148	19	73	40	190 - 280	1.5
8-251-040-02	4.0	M24	36	3.00	57	75	50	34.5	148	19	73	40	190 - 280	1.5
8-251-040-03	4.0	M24	45	3.00	57	75	50	34.5	148	19	73	40	190 - 280	1.5
8-251-040-04	4.0	M24	50	3.00	57	75	50	34.5	148	19	73	40	190 - 280	1.5
8-251-040-05	4.0	M30	35	3.50	57	75	50	34.5	148	19	73	40	190 - 280	1.5
8-251-067-01	6.7	M30	35	3.50	70	95	65	41	163	20	68	40	230 - 400	2.4
8-251-067-02	6.7	M30	45	3.50	70	95	65	41	163	20	68	40	230 - 400	2.4
8-251-067-03	6.7	M30	50	3.50	70	95	65	41	163	20	68	40	230 - 400	2.5
8-251-067-04	6.7	M30	60	3.50	70	95	65	41	163	20	68	40	230 - 400	2.5
8-251-080-01	8.0	M30	35	3.50	81	106	75	48	201	22	95	50	270 - 600	3.6
8-251-080-02	8.0	M30	45	3.50	81	106	75	48	201	22	95	50	270 - 600	3.7
8-251-100-01	10.0	M36	50	4.00	81	106	75	48	201	22	95	50	270 - 600	3.8
8-251-100-02	10.0	M36	54	4.00	81	106	75	48	201	22	95	50	270 - 600	3.9
8-251-125-01	12.5	M42	50	4.50	81	106	75	48	201	22	95	50	270 - 700	3.9
8-251-125-02	12.5	M42	60	4.50	81	106	75	48	201	22	95	50	270 - 700	4.0
8-251-125-03	12.5	M42	63	4.50	81	106	75	48	201	22	95	50	270 - 700	4.0
8-251-125-04	12.5	M45	60	4.50	81	106	75	48	201	22	95	50	270 - 700	4.1
8-251-125-05	12.5	M48	72	5.00	81	106	75	48	201	22	95	50	270 - 700	4.4
8-251-170-01	13.0	M42	60	4.50	104	127	95	58	256	32	129	70	350 - 800	7.4
8-251-170-02	17.0	M45	60	4.50	104	127	95	58	256	32	129	70	350 - 800	7.5
8-251-170-03	17.0	M48	60	5.00	104	127	95	58	256	32	129	70	350 - 800	7.6
8-251-170-04	17.0	M48	72	5.00	104	127	95	58	256	32	129	70	350 - 800	7.7
8-251-170-045	17.0	M52	78	5.00	104	127	95	58	256	32	129	70	350 - 800	7.9
8-251-170-05	18.0	M56	78	5.50	104	127	95	58	256	32	129	70	350 - 900	8.1
8-251-170-06	18.0	M56	84	5.50	104	127	95	58	256	32	129	70	350 - 900	8.1
8-251-200-01	20.0	M64	96	6.00	104	127	95	58	256	32	129	70	350 - 900	8.9
8-251-200-02	20.0	M64	110	6.00	104	127	95	58	256	32	129	70	350 - 900	9.3
8-251-280-01	28.0	M64	96	6.00	129	174	115	78	305	36	131	80	500 - 1000	16.4
8-251-280-02	28.0	M72	120	6.00	129	174	115	78	305	36	131	80	500 - 1200	17.7
8-251-280-03	28.0	M80	150	6.00	129	174	115	78	305	36	131	80	500 - 1200	19.6
8-251-350-005	35.0	M72	108	6.00	148	187	135	83	366	45	140	92	500 - 1400	24.8
8-251-350-01	35.0	M80	120	6.00	148	187	135	83	366	45	140	92	500 - 1400	25.3
8-251-350-02	35.0	M90	150	6.00	148	187	135	83	366	45	140	92	500 - 1500	27.8
8-251-400-005	40.0	M72	108	6.00	170	210	145	83	340	45	130	92	500 - 1500	30.1
8-251-400-01	40.0	M80	120	6.00	170	210	145	83	340	45	130	92	500 - 1500	31.9
8-251-400-02	40.0	M90	115	6.00	170	210	145	83	340	45	130	92	500 - 1500	33.6
8-251-400-025	40.0	M90	135	6.00	170	210	145	83	340	45	130	92	500 - 1500	33.9
8-251-400-03	40.0	M90	150	6.00	170	210	145	83	340	45	130	92	500 - 1500	34.2
8-251-400-04	40.0	M100	150	6.00	170	210	145	83	340	45	130	92	500 - 1700	35.2



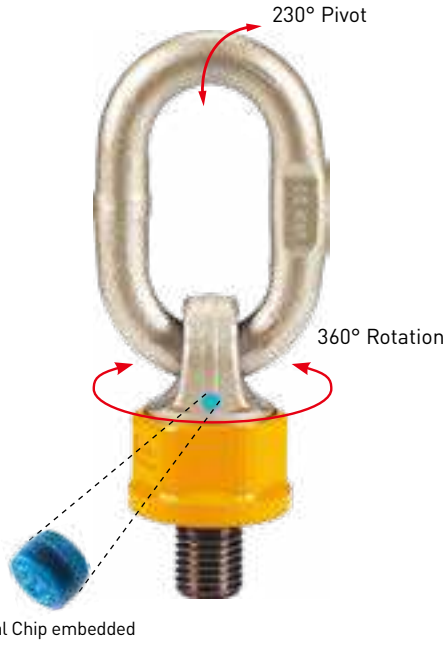
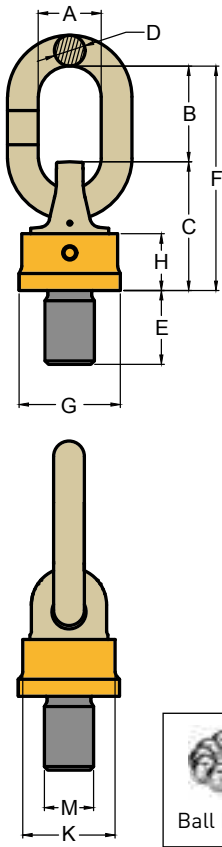

Digital Chip embedded with Certificate for serial Traceability

- Pivots to 230°, rotates through 360° due to its unique ball bearing design.
- Manufactured from forged alloy steel, quenched and tempered.
- Tested in accordance with EN1677-4.
- Load rated parts are 100% magnaflux crack detected.
- Individual forged parts and batch code links to Test Certificate sheet.
- Bolts are UNC thread.
- Proof tested to 2.5 times the WLL.
- Fatigue rated to 20,000 cycles at 1.5 times the WLL.
- All YOKE Lifting points meet or exceed all the requirements of ASME B30.26.
- Easy to attach or dismantle due to the forged hexagon shaped body of the Super Point.
- Capable of rotating under load. Do not turn continuously in 90 degree direction at full load.
- With the new WLL tables you can find the right Super Point attachment for your application and by the red marking on both sides you can measure disposal stage of the Super Point.

- » United States Patent: 10607128
- » UK Patent: 3627396
- » German Patent: 602018032891.2
- » Italy Patent: 3627396
- » Japan Patent: 3219858

Digital Super Point

UNC Thread (8-252)

Item No.	Working Load Limit tonnes	Thread version			Dimensions							Torque		N.W. lbs	
		M	E	TPI	G	C	K	H	F	D	B	A	in		Nm
		inch	inch		inch			inch							
8-252-007-01	0.5	3/8	0.56	16UNC	1.44	1.89	1.34	0.81	3.98	0.51	2.09	1.38	10 - 40	1.0	
8-252-007-02	0.7	1/2	0.75	13UNC	1.44	1.89	1.34	0.81	3.98	0.51	2.09	1.38	15 - 40	1.0	
8-252-014-02	1.4	5/8	0.94	11UNC	1.44	1.89	1.34	0.81	3.98	0.51	2.09	1.38	45 - 130	1.0	
8-252-025-01	2.5	3/4	1.13	10UNC	2.05	2.68	1.81	1.10	5.00	0.63	2.32	1.38	100 - 170	2.1	
8-252-040-02	4.0	1	1.50	8UNC	2.24	2.95	1.97	1.36	5.83	0.75	2.87	1.57	190 - 280	3.3	
8-252-067-02	6.7	1 1/4	1.88	7UNC	2.76	3.74	2.56	1.61	6.42	0.79	2.68	1.57	230 - 400	5.3	
8-252-080-02	8.0	1 1/4	1.88	7UNC	3.19	4.17	2.95	1.89	7.91	0.87	3.74	1.97	270 - 600	8.1	
8-252-100-02	10.0	1 1/2	2.25	6UNC	3.19	4.17	2.95	1.89	7.91	0.87	3.74	1.97	270 - 600	8.3	
8-252-125-03	12.5	1 3/4	2.63	5UNC	3.19	4.17	2.95	1.89	7.91	0.87	3.74	1.97	270 - 700	8.8	
8-252-125-05	12.5	2	3.00	4.5UNC	3.19	4.17	2.95	1.89	7.91	0.87	3.74	1.97	270 - 700	9.7	
8-252-170-04	17.0	2	3.00	4.5UNC	4.09	5.00	3.74	2.28	10.08	1.26	5.08	2.76	350 - 800	16.7	
8-252-170-06	18.0	2 1/4	3.38	4.5UNC	4.09	5.00	3.74	2.28	10.08	1.26	5.08	2.76	350 - 900	17.8	
8-252-200-01	20.0	2 1/2	3.75	4UNC	4.09	5.00	3.74	2.28	10.08	1.26	5.08	2.76	350 - 900	19.6	
8-252-280-01	28.0	2 1/2	3.75	4UNC	5.08	6.85	4.53	3.07	12.01	1.42	5.16	3.15	500 - 1000	36.1	
8-252-350-01	35.0	3 1/2	5.25	4UNC	5.83	7.36	5.31	3.27	14.41	1.77	5.51	3.62	500 - 1400	55.7	

* Design Factor 4:1



Kind of attachment											
Number of legs	Thread	1	2	1	2	2	2	2	3-4	3-4	3-4
Load direction	Thread	0°	0°	90°	90°	0-45°	45°- 60°	unsymm.	0 - 45°	45°- 60°	unsymm.
Item No.	Inch	WLL(t)									
8-252-007	3/8	1.0	2.0	0.5	1.0	0.70	0.5	0.5	1.0	0.75	0.5
	1/2	1.4	2.8	0.7	1.4	1.00	0.7	0.7	1.4	1.00	0.7
8-252-014	5/8	2.8	5.6	1.4	2.8	2.00	1.4	1.4	3.0	2.12	1.4
8-252-025	3/4	5.0	10.0	2.5	5.0	3.55	2.5	2.5	5.3	3.75	2.5
8-252-040	1	8.0	16.0	4.0	8.0	5.60	4.0	4.0	8.5	6.00	4.0
8-252-067	1 1/4	12.0	24.0	6.7	13.4	9.50	6.7	6.7	14.0	10.00	6.7
8-252-080	1 1/4	12.0	24.0	8.0	16.0	11.20	8.0	8.0	16.0	12.00	8.0
8-252-100	1 1/2	15.0	30.0	10.0	20.0	14.00	10.0	10.0	21.2	15.00	10.0
8-252-125	1 3/4	15.0	30.0	12.5	25.0	17.00	12.5	12.5	25.0	18.00	12.5
	2	15.0	30.0	12.5	25.0	17.00	12.5	12.5	25.0	18.00	12.5
8-252-170	2	25.0	50.0	17.0	34.0	23.50	17.0	17.0	35.0	25.00	17.0
	2 1/4	25.0	50.0	18.0	36.0	25.00	18.0	18.0	37.5	26.50	18.0
8-252-200	2 1/2	25.0	50.0	20.0	40.0	28.00	20.0	20.0	42.5	30.00	20.0
8-252-280	2 1/2	32.5	65.0	28.0	56.0	39.00	28.0	28.0	58.0	42.00	28.0
8-252-350	3 1/2	40.0	80.0	35.0	70.0	49.00	35.0	35.0	74.0	52.50	35.0

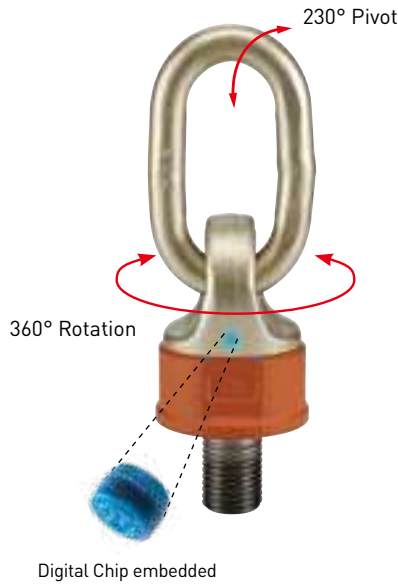
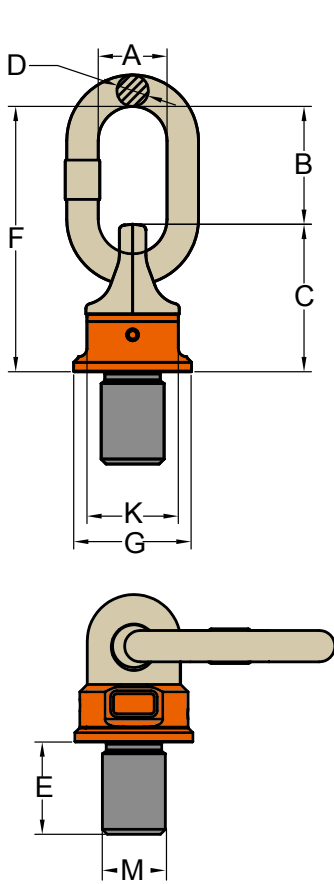

- Pivots to 230°, rotates through 360° due to its unique ball bearing design.
- Manufactured from forged alloy steel, quenched and tempered.
- Tested in accordance with DNV GL–ST-0378.
- Load rated parts are 100% magnaflux crack detected.
- Individual forged parts and batch code links to Test Certificate sheet.
- Bolts are Metric thread.
- Proof tested to 2.5 times the WLL.
- Fatigue rated to 20,000 cycles at 1.5 times the WLL.
- All YOKE Lifting points meet or exceed all the requirements of ASME B30.26.
- Easy to attach or dismantle due to the forged hexagon shaped body of the DA Swivel Point.
- Capable of rotating under load. Do not turn continuously in 90 degree direction at full load.

- » United States Patent: 10607128
- » UK Patent: 3627396
- » German Patent: 602018032891.2
- » Italy Patent: 3627396
- » Japan Patent: 3219858

Digital DA Swivel Point

Metric Thread (DA-271)

Digital Chip embedded with Certificate for serial Traceability



Item No.	Working Load Limit tonnes	Thread version			Dimensions							Torque Nm	N.W. kg	
		M	E	Pitch	G	C	K	F	D	B	A			
		mm	mm	DIN13	mm	mm	mm	mm	mm	mm	mm	mm		
DA-271-003	0.4	M 8	12	1.25	35	40	30	72	8	32	29	10	0.2	
DA-271-004	0.6	M 10	15	1.50	35	40	30	72	8	32	29	10	0.2	
DA-271-006	0.7	M 12	18	1.75	40	45	36	95	10	50	35	10	0.3	
DA-271-013	1.5	M 16	24	2.00	46	54	41	104	13	50	36	30	0.5	
DA-271-020	2.5	M 20	30	2.50	62	68	55	122	13	54	36	70	1.0	
DA-271-035	4.0	M 24	36	3.00	78	88	70	154	19	66	41	150	2.2	
DA-271-060	6.0	M 30	45	3.50	90	120	80	206	22	86	50	350	4.5	
DA-271-080	10.0	M 36	54	4.00	90	120	80	206	22	86	50	410	4.6	
DA-271-120	13.0	M 42	63	4.50	98	122	84	235	25	110	67	550	5.5	
DA-271-130	14.0	M 48	72	5.00	98	122	84	235	25	110	67	550	6.1	
DA-271-140	20.0	M 52	78	5.00	120	150	94	270	32	120	72	750	10.5	
DA-271-160	20.0	M 56	84	5.50	120	150	94	270	32	120	72	800	10.7	
DA-271-161	20.0	M 64	96	6.00	120	150	94	270	32	120	72	800	11.6	

* Design Factor 4:1



Kind of attachment											
Number of legs	1	2	1	2	2	2	2	3-4	3-4	3-4	
Load direction	0°	0°	90°	90°	0-45°	45°- 60°	unsymm.	0 - 45°	45°- 60°	unsymm.	
Item No.	Thread	WLL(t)									
DA-271-003	M 8	0.6	1.2	0.4	0.8	0.56	0.4	0.4	0.84	0.60	0.4
DA-271-004	M10	0.9	1.8	0.6	1.2	0.84	0.6	0.6	1.26	0.90	0.6
DA-271-006	M12	1.2	2.4	0.7	1.4	0.98	0.7	0.7	1.47	1.05	0.7
DA-271-013	M16	2.6	5.2	1.5	3.0	2.10	1.5	1.5	3.15	2.25	1.5
DA-271-020	M20	4.0	8.0	2.5	5.0	3.50	2.5	2.5	5.25	3.75	2.5
DA-271-035	M24	7.0	14.0	4.0	8.0	5.60	4.0	4.0	8.40	6.00	4.0
DA-271-060	M30	10.0	20.0	6.0	12.0	8.40	6.0	6.0	12.60	9.00	6.0
DA-271-080	M36	15.0	30.0	10.0	20.0	14.00	10.0	10.0	21.00	15.00	10.0
DA-271-120	M42	17.0	34.0	13.0	26.0	18.20	13.0	13.0	27.30	19.50	13.0
DA-271-130	M48	18.0	36.0	14.0	28.0	19.60	14.0	14.0	29.40	21.00	14.0
DA-271-140	M52	25.0	50.0	20.0	40.0	28.00	20.0	20.0	42.00	30.00	20.0
DA-271-160	M56	28.0	56.0	20.0	40.0	28.00	20.0	20.0	42.00	30.00	20.0
DA-271-161	M64	28.0	56.0	20.0	40.0	28.00	20.0	20.0	42.00	30.00	20.0

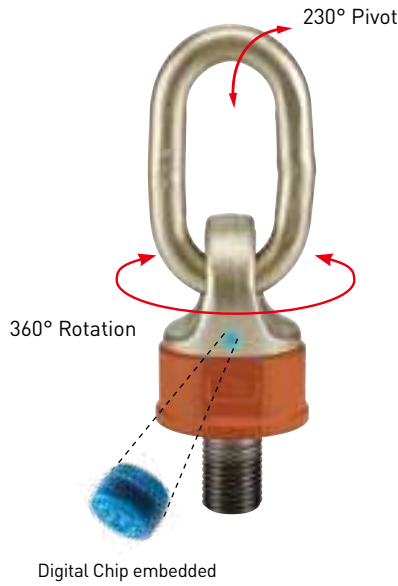
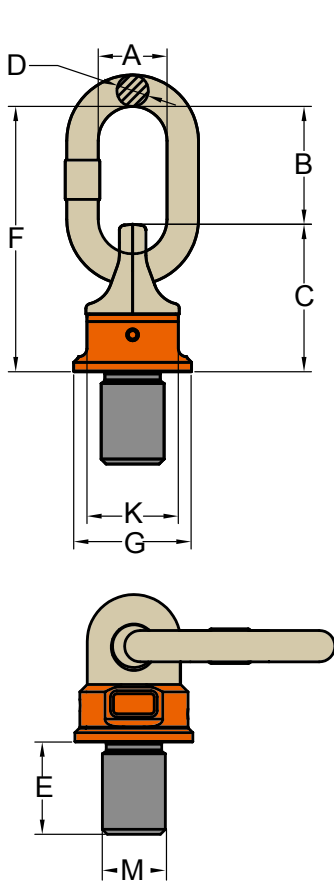

- Pivots to 230°, rotates through 360° due to its unique ball bearing design.
- Manufactured from forged alloy steel, quenched and tempered.
- Tested in accordance with DNV GL–ST-0378.
- Load rated parts are 100% magnaflux crack detected.
- Individual forged parts and batch code links to Test Certificate sheet.
- Bolts are UNC thread.
- Proof tested to 2.5 times the WLL.
- Fatigue rated to 20,000 cycles at 1.5 times the WLL.
- All YOKE Lifting points meet or exceed all the requirements of ASME B30.26.
- Easy to attach or dismantle due to the forged hexagon shaped body of the DA Swivel Point.
- Capable of rotating under load. Do not turn continuously in 90 degree direction at full load.

- » United States Patent: 10607128
- » UK Patent: 3627396
- » German Patent: 602018032891.2
- » Italy Patent: 3627396
- » Japan Patent: 3219858

Digital DA Swivel Point

UNC Thread (DA-272)

Digital Chip embedded with Certificate for serial Traceability

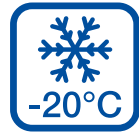

Item No.	Working Load Limit tonnes	Thread version			Dimensions							Torque in	
		M inch	E inch	TPI	G	C	K	F	D	B	A	Nm	lbs
DA-272-006	0.7	1/2	0.75	13UNC	1.57	1.77	1.42	3.74	0.39	1.97	1.38	15	0.7
DA-272-013	1.5	5/8	0.94	11UNC	1.81	2.13	1.61	4.09	0.51	1.97	1.42	45	1.2
DA-272-018	2.0	3/4	1.13	10UNC	1.81	2.68	1.61	4.09	0.51	1.97	1.42	45	1.2
DA-272-020	2.5	7/8	1.31	9UNC	2.44	2.68	2.17	4.80	0.51	2.13	1.42	100	2.2
DA-272-035	4.0	1	1.50	8UNC	3.07	3.46	2.76	6.06	0.75	2.60	1.61	190	4.8
DA-272-060	6.0	1 1/4	1.88	7UNC	3.54	4.72	3.15	8.11	0.87	3.39	1.97	270	9.9
DA-272-080	10.0	1 1/2	2.25	6UNC	3.54	4.72	3.15	8.11	0.87	3.39	1.97	270	10.0
DA-272-120	13.0	1 3/4	2.63	5UNC	3.86	4.80	3.31	9.25	0.98	4.33	2.64	350	12.1
DA-272-130	14.0	2	3.00	4.5UNC	3.86	4.80	3.31	9.25	0.98	4.33	2.64	350	13.5
DA-272-140	20.0	2 1/4	3.38	4.5UNC	4.72	5.91	3.70	10.63	1.26	4.72	2.85	350	23.1
DA-272-160	20.0	2 1/2	3.75	4UNC	4.72	5.91	3.70	10.63	1.26	4.72	2.85	350	23.5

* Design Factor 4:1



Kind of attachment											
Number of legs	Thread	1	2	1	2	2	2	2	3-4	3-4	3-4
Load direction	Thread	0°	0°	90°	90°	0-45°	45°- 60°	unsymm.	0 - 45°	45°- 60°	unsymm.
Item No.	Inch	WLL(t)									
DA-272-006	1/2	1.2	2.4	0.7	1.4	0.98	0.7	0.7	1.47	1.05	0.7
DA-272-013	5/8	2.6	5.2	1.5	3.0	2.10	1.5	1.5	3.15	2.25	1.5
DA-272-018	3/4	3.6	7.2	2.0	4.0	2.80	2.0	2.0	4.20	3.00	2.0
DA-272-020	7/8	4.0	8.0	2.5	5.0	3.50	2.5	2.5	5.25	3.75	2.5
DA-272-035	1	7.0	14.0	4.0	8.0	5.60	4.0	4.0	8.40	6.00	4.0
DA-272-060	1 1/4	10.0	20.0	6.0	12.0	8.40	6.0	6.0	12.60	9.00	6.0
DA-272-080	1 1/2	15.0	30.0	10.0	20.0	14.00	10.0	10.0	21.00	15.00	10.0
DA-272-120	1 3/4	17.0	34.0	13.0	26.0	18.20	13.0	13.0	27.30	19.50	13.0
DA-272-130	2	18.0	36.0	14.0	28.0	19.60	14.0	14.0	29.40	21.00	14.0
DA-272-140	2 1/4	25.0	50.0	20.0	40.0	28.00	20.0	20.0	42.00	30.00	20.0
DA-272-160	2 1/2	28.0	56.0	20.0	40.0	28.00	20.0	20.0	42.00	30.00	20.0

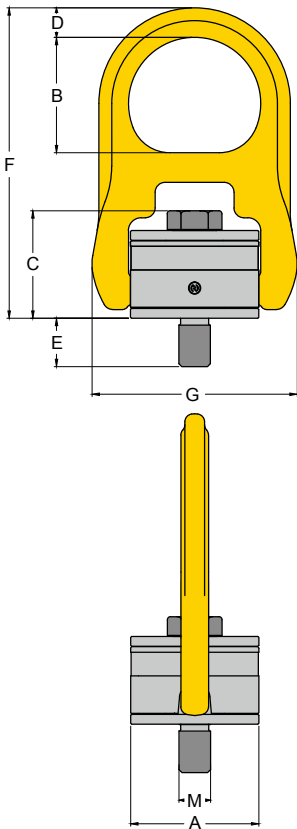

Digital Chip embedded

Digital Chip embedded with Certificate for serial Traceability

- Rotates through 360° and pivots 180°, and simultaneously allows lifting from any direction.
- Manufactured from forged alloy steel, quenched and tempered.
- Manufactured and tested in accordance with EN1677-1.
- Load rated parts are 100% magnaflux crack detected.
- Individual forged parts and cap screw are traceable to Test Certification.
- Bolts are Metric thread.
- Proof tested to 2.5 times the WLL.
- Fatigue rated to 20,000 cycles at 1.5 times the WLL.
- All YOKE Lifting points meet or exceed all the requirements of ASME B30.26.
- Quick and simple assembly, just a tapped hole is required

- » United States Patent: 10607128
- » UK Patent: 3627396
- » German Patent: 602018032891.2
- » Italy Patent: 3627396
- » Japan Patent: 3219858
- » China Patent: ZL 2012 1 0131962.1
- » Taiwan Patent: 1468602

Digital Hoist Ring

Metric Thread (8-203)

NEW

Kind of attachment											
Number of legs	Load direction	1	2	1	2	2	2	2	3-4	3-4	3-4
Item No.	Thread	WLL(t)									
8-203-0041	M 8	0.50	1.0	0.50	1.0	0.70	0.50	0.50	1.05	0.75	0.50
8-203-0051	M10	0.55	1.1	0.55	1.1	0.77	0.55	0.55	1.16	0.83	0.55
8-203-0101	M12	1.30	2.6	1.30	2.6	1.82	1.30	1.30	2.73	1.95	1.30
8-203-0191	M16	2.40	4.8	2.40	4.8	3.36	2.40	2.40	5.04	3.60	2.40
8-203-0211	M20	2.70	5.4	2.70	5.4	3.78	2.70	2.70	5.67	4.05	2.70
8-203-0301	M20	3.75	7.5	3.75	7.5	5.25	3.75	3.75	7.88	5.63	3.75
8-203-0421	M24	5.25	10.5	5.25	10.5	7.35	5.25	5.25	11.03	7.88	5.25
8-203-0701	M30	8.75	17.5	8.75	17.5	12.25	8.75	8.75	18.38	13.13	8.75
8-203-0801	M36	10.00	20.0	10.00	20.0	14.00	10.00	10.00	21.00	15.00	10.00
8-203-1001	M36	12.50	25.0	12.50	25.0	17.50	12.50	12.50	26.25	18.75	12.50
8-203-1251	M42	15.60	31.2	15.60	31.2	21.84	15.60	15.60	32.76	23.40	15.60
8-203-1351	M48	16.90	33.8	16.90	33.5	23.66	16.90	16.90	35.49	25.35	16.90

Item No.	Working Load Limit		Thread version			Dimensions						Torque in	N.W.
	tonnes		M	E	Pitch	A	B	C	D	F	G	Nm	kg
	5 : 1	4 : 1	mm		DIN13			mm					
8-203-0041	0.40	0.50	M 8	12	1.25	40	41	38	10	101	65	10	0.4
8-203-0051	0.45	0.55	M10	15	1.50	40	41	39	10	101	65	16	0.5
8-203-0101	1.05	1.30	M12	18	1.75	65	59	52	15	157	104	38	1.7
8-203-0191	1.90	2.40	M16	24	2.00	65	59	55	15	157	104	81	1.8
8-203-0211	2.15	2.70	M20	30	2.50	65	59	57	15	157	104	136	1.8
8-203-0301	3.00	3.75	M20	30	2.50	85	74	67	22	203	134	136	4.0
8-203-0421	4.20	5.25	M24	36	3.00	85	74	69	22	203	134	312	4.2
8-203-0701	7.00	8.75	M30	45	3.50	100	80	77	25	216	160	637	6.6
8-203-0801	8.00	10.00	M36	54	4.00	100	80	81	25	216	160	1005	6.9
8-203-1001	10.00	12.50	M36	54	4.00	120	106	108	36	306	220	1005	15.0
8-203-1251	12.50	15.60	M42	63	4.50	120	106	111	36	306	220	1005	16.0
8-203-1351	13.50	16.90	M48	72	5.00	120	106	115	36	306	220	1350	16.0

Item No.	Working Load Limit		Thread version			Dimensions						Torque in	N.W.
	tonnes		M	E	Pitch	A	B	C	D	F	G	Nm	kg
	5 : 1	4 : 1	mm		DIN13			mm					
8-203-004	0.40	0.50	M 8	17	1.25	40	41	41	10	101	65	10	0.4
8-203-005	0.45	0.55	M10	11	1.50	40	41	43	10	101	65	16	0.5
§ 8-203-005L	0.45	0.55	M10	26	1.50	40	41	43	10	101	65	16	0.5
8-203-010	1.05	1.30	M12	15	1.75	65	59	57	15	157	104	38	1.7
§ 8-203-010L	1.05	1.30	M12	30	1.75	65	59	57	15	157	104	38	1.7
8-203-019	1.90	2.40	M16	20	2.00	65	59	61	15	157	104	81	1.8
§ 8-203-019L	1.90	2.40	M16	35	2.00	65	59	61	15	157	104	81	1.8
8-203-021	2.15	2.70	M20	25	2.50	65	59	65	15	157	104	136	1.8
§ 8-203-021L	2.15	2.70	M20	45	2.50	65	59	65	15	157	104	136	1.9
8-203-030	3.00	3.75	M20	25	2.50	85	74	74	22	203	134	136	4.0
§ 8-203-030L	3.00	3.75	M20	45	2.50	85	74	74	22	203	134	136	5.2
8-203-042	4.20	5.25	M24	26	3.00	85	74	78	22	203	134	312	4.2
§ 8-203-042L	4.20	5.25	M24	56	3.00	85	74	78	22	203	134	312	4.3
8-203-070	7.00	8.75	M30	81	3.50	100	80	77	25	216	160	637	6.6
8-203-110	11.00	13.75	M36	76	4.00	120	106	108	36	306	220	1005	15.0
8-203-125	12.50	15.60	M42	65	4.50	120	106	111	36	306	220	1005	16.0
8-203-135	13.50	16.90	M48	70	5.00	120	106	115	36	306	220	1350	16.0

§ Long Bolts are designed for soft metal work piece.

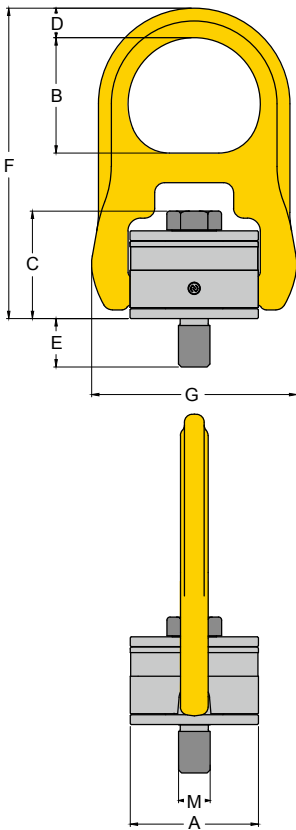

Digital Chip embedded

Digital Chip embedded with Certificate for serial Traceability

- Rotates through 360° and pivots 180°, and simultaneously allows lifting from any direction.
- Manufactured from forged alloy steel, quenched and tempered.
- Manufactured and tested in accordance with EN1677-1.
- Load rated parts are 100% magnaflux crack detected.
- Individual forged parts and cap screw are traceable to Test Certification.
- Bolts are UNC thread.
- Proof tested to 2.5 times the WLL.
- Fatigue rated to 20,000 cycles at 1.5 times the WLL.
- All YOKE Lifting points meet or exceed all the requirements of ASME B30.26.
- Quick and simple assembly, just a tapped hole is required.

- » United States Patent: 10607128
- » UK Patent: 3627396
- » German Patent: 602018032891.2
- » Italy Patent: 3627396
- » Japan Patent: 3219858
- » China Patent: ZL 2012 1 0131962.1
- » Taiwan Patent: I468602

Digital Hoist Ring

UNC Thread (8-204)

NEW

Kind of attachment											
Number of legs	Thread	1	2	1	2	2	2	2	3-4	3-4	3-4
Item No.	Inch	WLL(t)									
8-204-0041	5/16	0.36	0.72	0.36	0.72	0.50	0.36	0.36	0.76	0.54	0.36
8-204-0051	3/8	0.45	0.90	0.45	0.90	0.63	0.45	0.45	0.95	0.68	0.45
8-204-0101	1/2	1.10	2.20	1.10	2.20	1.54	1.10	1.10	2.31	1.65	1.10
8-204-0191	5/8	1.80	3.60	1.80	3.60	2.52	1.80	1.80	3.78	2.70	1.80
8-204-0211	3/4	2.20	4.40	2.20	4.40	3.08	2.20	2.20	4.62	3.30	2.20
8-204-0301	3/4	3.10	6.20	3.10	6.20	4.34	3.10	3.10	6.51	4.65	3.10
8-204-0421	7/8	3.60	7.20	3.60	7.20	5.04	3.60	3.60	7.56	5.40	3.60
8-204-0451	1	4.50	9.00	4.50	9.00	6.30	4.50	4.50	9.45	6.75	4.50
8-204-0701	1 1/4	6.80	13.60	6.80	13.60	9.52	6.80	6.80	14.28	10.20	6.80
8-204-1251	1 1/2	10.90	21.80	10.90	21.80	15.26	10.90	10.90	22.89	16.30	10.90
8-204-1351	2	13.60	27.20	13.60	27.20	19.04	13.60	13.60	28.56	20.40	13.60

Item No.	Working Load Limit		Thread version			Dimensions						Torque in	N.W.
	lbs		M	E	TPI	A	B	C	D	F	G	ft.lbs	lbs
	5:1	4:1	inch	inch				mm					
8-204-0041	800	1000	5/16	0.47	18UNC	1.57	1.61	1.61	0.35	4.02	2.56	7	0.9
8-204-0051	1000	1250	3/8	0.56	16UNC	1.57	1.61	1.69	0.35	4.02	2.56	12	0.9
8-204-0101	2500	3125	1/2	0.75	13UNC	2.56	2.32	2.24	0.59	6.26	4.13	28	3.7
8-204-0191	4000	5000	5/8	0.94	11UNC	2.56	2.32	2.38	0.59	6.26	4.13	60	4.0
8-204-0211	5000	6250	3/4	1.13	10UNC	2.56	2.32	2.51	0.59	6.26	4.13	100	4.0
8-204-0301	7000	8750	3/4	1.13	10UNC	3.35	2.87	2.87	0.87	8.03	5.28	100	8.8
8-204-0421	8000	10000	7/8	1.31	9UNC	3.35	2.87	3.07	0.87	8.03	5.28	160	9.3
8-204-0451	10000	12500	1	1.50	8UNC	3.35	2.87	3.07	0.87	8.03	5.28	230	9.5
8-204-0701	15000	18750	1 1/4	1.88	7UNC	3.95	3.15	3.06	1.00	8.58	6.30	470	14.4
8-204-1251	24000	30000	1 1/2	2.25	6UNC	4.72	4.17	4.29	1.41	12.09	8.66	800	35.1
8-204-1351	30000	37500	2	3.00	4.5UNC	4.72	4.17	4.54	1.41	12.09	8.66	1100	35.2

Item No.	Working Load Limit		Thread version			Dimensions						Torque in	N.W.
	lbs		M	E	TPI	A	B	C	D	F	G	ft.lbs	lbs
	5:1	4:1	inch	inch				mm					
8-204-004	800	1000	5/16	0.71	18UNC	1.57	1.61	1.61	0.35	4.02	2.56	7	0.9
8-204-005	1000	1250	3/8	0.71	16UNC	1.57	1.61	1.69	0.35	4.02	2.56	12	0.9
8-204-010	2500	3125	1/2	0.75	13UNC	2.56	2.32	2.24	0.59	6.26	4.13	28	3.7
8-204-010L	2500	3125	1/2	1.26	13UNC	2.56	2.32	2.24	0.59	6.26	4.13	28	3.7
8-204-019	4000	5000	5/8	0.74	11UNC	2.56	2.32	2.38	0.59	6.26	4.13	60	4.0
8-204-019L	4000	5000	5/8	1.75	11UNC	2.56	2.32	2.38	0.59	6.26	4.13	60	4.0
8-204-021	5000	6250	3/4	1.24	10UNC	2.56	2.32	2.51	0.59	6.26	4.13	100	4.0
8-204-021L	5000	6250	3/4	1.73	10UNC	2.56	2.32	2.51	0.59	6.26	4.13	100	4.2
8-204-030	7000	8750	3/4	0.87	10UNC	3.35	2.87	2.87	0.87	8.03	5.28	100	8.8
8-204-030L	7000	8750	3/4	1.87	10UNC	3.35	2.87	2.87	0.87	8.03	5.28	100	9.5
8-204-042	8000	10000	7/8	1.38	9UNC	3.35	2.87	3.07	0.87	8.03	5.28	160	9.3
8-204-042L	8000	10000	7/8	2.37	9UNC	3.35	2.87	3.07	0.87	8.03	5.28	160	9.7
8-204-045	10000	12500	1	1.38	8UNC	3.35	2.87	3.07	0.87	8.03	5.28	230	9.5
8-204-045L	10000	12500	1	2.37	8UNC	3.35	2.87	3.07	0.87	8.03	5.28	230	10.1
8-204-070	15000	18750	1 1/4	2.25	7UNC	3.95	3.15	3.06	1.00	8.58	6.30	470	14.5
8-204-125	24000	30000	1 1/2	2.17	6UNC	4.72	4.17	4.29	1.41	12.09	8.66	800	35.2
8-204-135	30000	37500	2	3.01	4.5UNC	4.72	4.17	4.54	1.41	12.09	8.66	1100	35.2





Anchor Point for Personal Protective Equipment



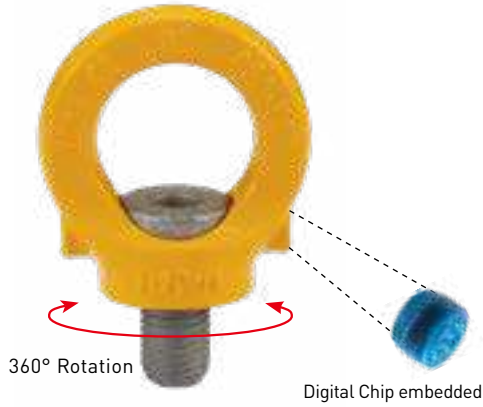
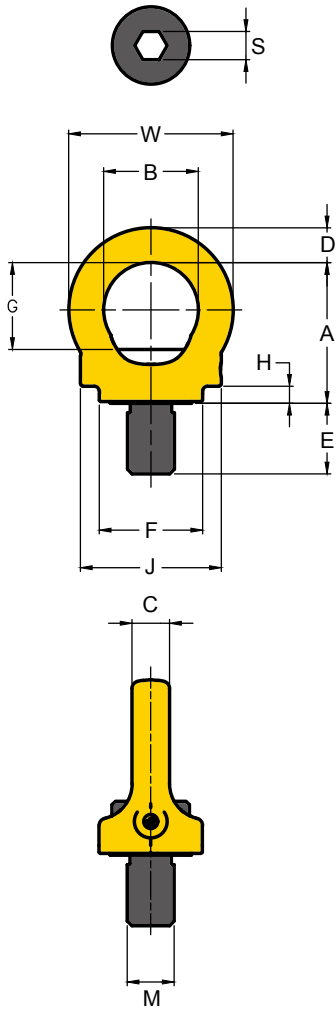

Anchor Point for Personal Protective Equipment

Digital Chip embedded with Certificate for serial Traceability

- Rotates through 360° adjustable in the direction of the load.
- Manufactured from forged alloy steel, quenched and tempered.
- Tested in accordance with EN795 or TS16415.
- Certified by PSA of DGUV.
- Load rated parts are 100% magnaflux crack detected.
- Individual forged parts and cap screw are traceable to Test Certification.
- Passed 22.2 KN/person Load testing.
- Passed 100kg or 150 kg dynamic fall testing (EU standard is 100 kg).
- Meets all requirements of the German BG BAU (Employer's insurance association of the building industry).
- Meets all requirements of DIN EN795, DIN EN50308, OSHA1926.502.
- Acc. to DIN EN 365 including statement for the number of load bearing persons is 1-2 persons.
- YOKE yellow powder coating for high visibility.
- PSA - Lifting point to be as an anchor point for personal protective equipment.

- » Mexico Patent: 3423
- » Japan Patent: 3192016"
- » China Patent: ZL 2014 2 0228663.4
- » China Patent: ZL 2012 1 0131962.1
- » Taiwan Patent: 1468602
- » United States Patent: 10607128
- » UK Patent: 3627396
- » German Patent: 602018032891.2
- » Italy Patent: 3627396
- » Japan Patent: 3219858

Digital PSA-YEP

Metric (8-281)

Item No.	Working Load Limit	Thread version	Dimensions(mm)											Torque	N.W.
			M	A	B	C	D	E	F	G	H	J	S	W	
8-281-007	1 Pers	M12x1.75	45	30	10	11	18	33	29	5	45	8	52	10	0.2
8-281-015	1-2 Pers	M16x2.0	52	35	14	13	24	35	33	8	52	10	61	30	0.3
8-281-023	1-2 Pers	M20x2.5	60	40	16	15	30	44	37	7	60	12	70	70	0.6

Item No.	Working Load Limit	Thread version	Dimensions(inch)											Torque	N.W.
			M	A	B	C	D	E	F	G	H	J	S	W	
8-281-007	1 Pers	M12x1.75	1.8	1.2	0.4	0.4	0.7	1.3	1.1	0.2	1.8	0.3	2.0	7.4	0.4
8-281-015	1-2 Pers	M16x2.0	2.0	1.4	0.6	0.5	0.9	1.4	1.3	0.3	2.0	0.4	2.4	22.1	0.7
8-281-023	1-2 Pers	M20x2.5	2.4	1.6	0.6	0.6	1.2	1.7	1.5	0.3	2.4	0.5	2.8	51.7	1.3

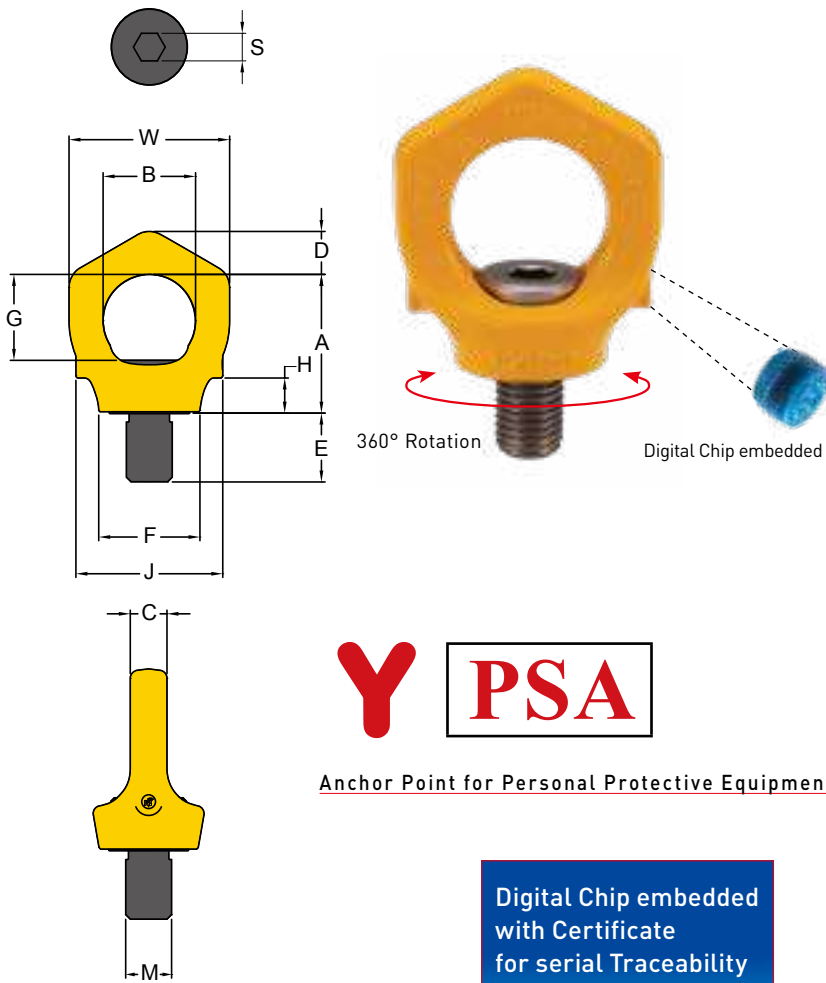

- Rotates through 360° adjustable in the direction of the load.
- Manufactured from forged stainless steel.
- Tested in accordance with EN795 or TS16415.
- Load rated parts are 100% magnaflux crack detected.
- Individual forged parts and cap screw are traceable to Test Certification.
- Passed 22.2KN/person load testing.
- Passed 100kg or 150 kg dynamic fall testing (EU standard is 100 kg).
- Meets all requirements of the German BG BAU (Employer’s insurance association of the building industry).
- Meets all requirements of DIN EN795, DIN EN50308, OSHA1926.502.
- Acc. to DIN EN 365 including statement for the number of load bearing persons is 1-2 persons.
- YOKE yellow powder coating for high visibility.
- Suitable for permanently outdoor application.
- PSA-INOX Lifting point to be as an anchor point for personal protective equipment.

Digital Chip embedded with Certificate for serial Traceability

- » Mexico Patent: 3423
- » Japan Patent: 3192016"
- » China Patent: ZL 2014 2 0228663.4
- » China Patent: ZL 2012 1 0131962.1
- » Taiwan Patent: I468602
- » United States Patent: 10607128
- » UK Patent: 3627396
- » German Patent: 602018032891.2
- » Italy Patent: 3627396
- » Japan Patent: 3219858

Digital PSA-INOX-YEP

Metric (8-285) stainless steel

Item No.	Working Load Limit	Thread version	Dimensions(mm)											Torque	
			M	A	B	C	D	E	F	G	H	J	S	W	Nm
8-285-007	1 Pers	M12x1.75	45	30	10	14	18	33	29	9	48	8	52	10	0.2
8-285-015	1-2 Pers	M16x2.0	52	35	14	16	24	35	33	12	56	10	61	30	0.4
8-285-023	1-2 Pers	M20x2.5	60	40	16	19	30	44	37	15	64	12	70	70	0.6

Item No.	Working Load Limit	Thread version	Dimensions(inch)											Torque	
			M	A	B	C	D	E	F	G	H	J	S	W	ft. lbs
8-285-007	1 Pers	M12x1.75	1.8	1.2	0.4	0.6	0.7	1.3	1.1	0.4	1.9	0.3	2.0	7.4	0.4
8-285-015	1-2 Pers	M16x2.0	2.0	1.4	0.6	0.6	0.9	1.4	1.3	0.5	2.2	0.4	2.4	22.1	0.9
8-285-023	1-2 Pers	M20x2.5	2.4	1.6	0.6	0.7	1.2	1.7	1.5	0.6	2.5	0.5	2.8	51.7	1.3

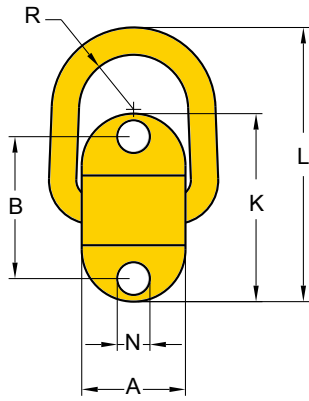

- Pivots 180° and allows side load lifting.
- Manufactured from forged alloy steel, quenched and tempered.
- Manufactured and tested in accordance with EN1677-1.
- Load rated parts are 100% magnaflux crack detected.
- Individual forged parts are traceable to Test Certification.
- Supplied without bolts; usage of Grade 10.9 or Grade 12.9 bolts is recommended.
- Proof tested to 2.5 times the WLL.
- All YOKE Lifting points meet or exceed all the requirements of ASME B30.26.

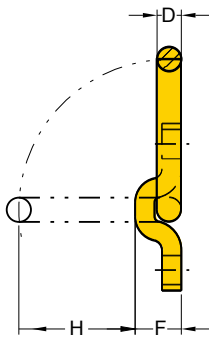

Bolt-on Tie Down.

Designed with spring, stop at any angle supplied without bolt (8-058)

Item No.	Working Load Limit tonnes	Dimensions (mm)									Bolt size Thread	N.W. kg
		A	B	D	F	H	K	L	N	R		
8-058-1T	1.0	50	72	14	27	55	98	139	14	24	M12	0.7
8-058-3T	3.0	58	84	17	34	53	114	147	18	29	M16	1.1
8-058-5T	5.0	64	117	22	46	74	160	206	23	33	M20/M22	2.5

* Design Factor 5:1

Item No.	Working Load Limit tonnes	Dimensions (inch)									N.W. lbs
		A	B	D	F	H	K	L	N	R	
8-058-1T	1.0	1.97	2.83	0.55	1.06	2.17	3.86	5.47	0.55	0.94	1.5
8-058-3T	3.0	2.28	3.31	0.67	1.33	2.09	4.49	5.79	0.71	1.14	2.4
8-058-5T	5.0	2.52	4.61	0.87	1.81	2.91	6.30	8.11	0.91	1.30	5.5

* Design Factor 5:1



Weld-on Lifting Points





Weld-on Point

Classic Weld-on Point

Weld-on Ring

Weld-on Hook

Excavator Hook

Super Weld-on Point

8-057

8-0573

8-082

8-081

8-083

8-0575

Kind of attachment

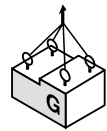
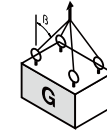
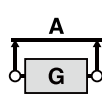

Number of legs	1	2	1	2	2	2	2	3-4	3-4	3-4
Load direction	0°	0°	90°	90°	0-45°	45°- 60°	unsymm.	0 - 45°	45°- 60°	unsymm.
Item No.	WLL(t)									
8-0573-01	1.00	2.0	1.00	2.0	1.40	1.00	1.00	2.10	1.50	1.00
8-0573-03	3.00	6.0	3.00	6.0	4.20	3.00	3.00	6.30	4.50	3.00
8-0573-05	5.00	10.0	5.00	10.0	7.00	5.00	5.00	10.50	7.50	5.00
8-0573-08	8.00	16.0	8.00	16.0	11.20	8.00	8.00	16.80	12.00	8.00
8-0573-10	10.00	20.0	10.00	20.0	14.00	10.00	10.00	21.00	15.00	10.00
8-0573-20	20.00	40.0	20.00	40.0	28.00	20.00	20.00	42.00	30.00	20.00
8-0573-30	30.00	60.0	30.00	60.0	42.00	30.00	30.00	63.00	45.00	30.00
8-057-1T	1.00	2.0	1.00	2.0	1.40	1.00	1.00	2.10	1.50	1.00
8-057-3T	3.00	6.0	3.00	6.0	4.20	3.00	3.00	6.30	4.50	3.00
8-057-5T	5.00	10.0	5.00	10.0	7.00	5.00	5.00	10.50	7.50	5.00
8-057-8T	8.00	16.0	8.00	16.0	11.20	8.00	8.00	16.80	12.00	8.00
8-057-10T	10.00	20.0	10.00	20.0	14.00	10.00	10.00	21.00	15.00	10.00
8-082-04	4.00	8.0	4.00	8.0	5.60	4.00	4.00	8.40	6.00	4.00
8-082-06	6.700	13.4	6.700	13.4	9.40	6.70	6.70	14.10	10.10	6.70
8-082-10	10.00	20.0	10.00	20.0	14.00	10.00	10.00	21.00	15.00	10.00
8-082-16	16.00	32.0	16.00	32.0	22.40	16.00	16.00	33.60	24.00	16.00
8-082-30	31.50	63.0	31.50	63.0	44.10	31.50	31.50	66.20	47.30	31.50
8-083-0075	0.75	1.5	0.75	1.5	1.05	0.75	0.75	1.58	1.13	0.75
8-081-01/8-083-01	1.00	2.0	1.00	2.0	1.40	1.00	1.00	2.10	1.50	1.00
8-081-02/8-083-02	2.00	4.0	2.00	4.0	2.80	2.00	2.00	4.20	3.00	2.00
8-081-03/8-083-03	3.00	6.0	3.00	6.0	4.20	3.00	3.00	6.30	4.50	3.00
8-081-04/8-083-04	4.00	8.0	4.00	8.0	5.60	4.00	4.00	8.40	6.00	4.00
8-081-05/8-083-05	5.00	10.0	5.00	10.0	7.00	5.00	5.00	10.50	7.50	5.00
8-081-08/8-083-08	8.00	16.0	8.00	16.0	11.20	8.00	8.00	16.80	12.00	8.00
8-081-10/8-083-10	10.00	20.0	10.00	20.0	14.00	10.00	10.00	21.00	15.00	10.00
8-081-15/8-083-15	15.00	30.0	15.00	30.0	21.00	15.00	15.00	31.50	22.50	15.00
8-0575-015	1.50	3.0	1.50	3.0	2.10	1.50	1.50	3.20	2.30	1.50
8-0575-025	2.50	5.0	2.50	5.0	3.50	2.50	2.50	5.30	3.80	2.50
8-0575-040	4.00	8.0	4.00	8.0	5.60	4.00	4.00	8.40	6.00	4.00
8-0575-067	6.70	13.4	6.70	13.4	9.40	6.70	6.70	14.10	10.10	6.70
8-0575-100	10.00	20.0	10.00	20.0	14.00	10.00	10.00	21.00	15.00	10.00
8-0575-160	16.00	32.0	16.00	32.0	22.40	16.00	16.00	33.60	24.00	16.00



WELDING INSTRUCTIONS

The welding should only be carried out by qualified welder according to Standards, e.g. EN 287 or AWS.

Support material

- Material of the welding block is S355J2+N (1.0577+N, St 52-3N, B.S. 4360.50D, AISI 1019 etc.).
- Prior to welding, the contact areas must be free from impurities, oil, paint, rust, scale, etc., for example by grinding. If the surface is at all corroded, all rust must be completely removed from the weld area. Painted surface must be prepared in the same way.
- The steel support member must have a carbon content of no more than 0.40%.
- In ambient temperature of 10°C and below, pre-heating of the weld area prior to welding must be carried out.

Seam welding

- The welds must be sufficiently strong to take the required loads.
- Before starting the final weld pass, clean well the root pass to avoid inclusions.
- The complete welding operation must be carried out continuously so that the parts do not have time to cool.
- Effects of temperature
 - The complete construction can be annealed stress release at <600°C without reduction of WLL.
 - Do not rapidly cool the weld.
- A thorough inspection of the weld should be performed. No cracks, pitting, inclusions, notches or undercuts are allowed. If doubt exists, use a suitable NDT method, such as magnetic particle or liquid penetrant to verify.
- If repair is required, grind out the defect and re-weld using the original qualified procedure.

Welding materials

- Weld materials must have a minimum tensile strength of 70,000 PSI (such as AWS A5.1 E-7018), following the electrode manufacturer's recommendations. Reference information as below:

MIG arc welding:

- Wire diameter 0.8 - 1.2 as per DIN 8559-SG 3, AWS A 5.18.
- Important: do not weld in the open air during bad weather

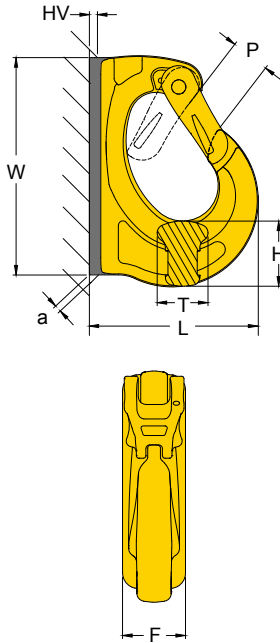

- Manufactured from forged alloy steel, quenched and tempered.
- Tested and certified by DGUV GS-0A-15-03.
- Load rated parts are 100% magnaflux crack detected.
- Individual forged parts are traceable to Test Certification.
- All YOKE Lifting points meet or exceed all the requirements of ASME B30.26.
- WLL forged onto each product for quick and easy identification.
- Lugs designed to assist the welding process.

Excavator Hook

Metric (8-083)

Item No.	Working Load Limit tonnes	Dimensions (mm)								N.W. kg
		F	H	L	P	T	W	HV	a	
8-083-0075	0.75	19	20	56	19	13	82	5	3	0.3
8-083-01	1.00	25	27	72	27	17	95	6	4	0.6
8-083-02	2.00	30	30	86	33	20	114	8	5	0.9
8-083-03	3.00	35	32	105	30	23	132	10	6	1.4
8-083-04	4.00	42	38	112	30	29	140	11	7	1.9
8-083-05	5.00	45	47	131	32	30	165	12	8	2.9
8-083-08	8.00	50	51	133	34	40	172	13	9	3.5
8-083-10	10.00	55	57	170	51	43	220	14	9	6.3
8-083-15	15.00	60	67	191	53	50	240	15	12	8.8

* Design factor 5:1

YOKE recommends that the working load limit should be reduced to meet any appropriate legislative requirements, if welding on to an excavator. Please contact your YOKE distributors for further information.

Item No.	Working Load Limit tonnes	Dimensions (inch)								N.W. lbs
		F	H	L	P	T	W	HV	a	
8-083-0075	0.75	0.75	0.79	2.20	0.75	0.51	3.21	0.20	0.12	0.6
8-083-01	1.00	0.98	1.06	2.83	1.06	0.67	3.74	0.24	0.16	1.2
8-083-02	2.00	1.18	1.18	3.39	1.30	0.79	4.49	0.31	0.20	2.0
8-083-03	3.00	1.38	1.26	4.13	1.18	0.91	5.20	0.39	0.24	3.1
8-083-04	4.00	1.65	1.50	4.41	1.18	1.14	5.51	0.43	0.28	4.3
8-083-05	5.00	1.77	1.85	5.16	1.26	1.18	6.50	0.47	0.31	6.3
8-083-08	8.00	1.97	2.01	5.24	1.34	1.57	6.77	0.51	0.35	7.7
8-083-10	10.00	2.17	2.24	6.69	2.01	1.69	8.66	0.55	0.35	14.0
8-083-15	15.00	2.36	2.64	7.52	2.09	1.97	9.45	0.59	0.47	19.3

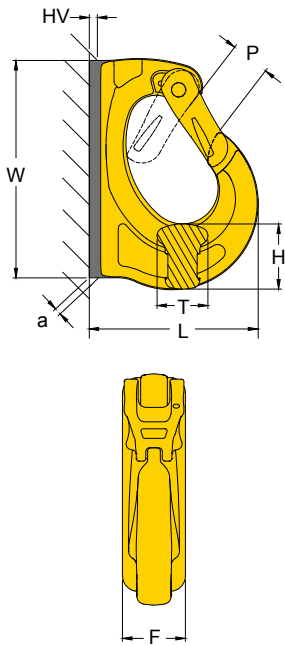

- Manufactured from forged alloy steel, quenched and tempered.
- Tested and certified by DGUV GS-0A-15-03.
- Load rated parts are 100% magnaflux crack detected.
- Individual forged parts are traceable to Test Certification.
- All YOKE Lifting points meet or exceed all the requirements of ASME B30.26.
- WLL forged onto each product for quick and easy identification.
- Lugs designed to assist the welding process.

Weld-on Hook

Metric (8-081)

Item No.	Working Load Limit	Dimensions (mm)								N.W.
	tonnes	F	H	L	P	T	W	HV	a	kg
8-081-01	1.0	25	27	72	18	18	95	7	4	0.6
8-081-02	2.0	30	30	85	25	20	115	8	5	1.0
8-081-03	3.0	35	30	105	28	23	133	9	6	1.4
8-081-04	4.0	42	38	111	28	30	142	10	7	2.2
8-081-05	5.0	44	47	132	30	31	167	12	7	3.0
8-081-08	8.0	50	52	134	32	39	176	12	8	3.7
8-081-10	10.0	56	56	168	44	42	222	13	8	6.2
8-081-15	15.0	61	67	184	54	45	242	14	10	7.9

* Design factor 5:1

YOKE recommends that the working load limit should be reduced to meet any appropriate legislative requirements, if welding on to an excavator. Please contact your YOKE distributors for further information.

Item No.	Working Load Limit	Dimensions (inch)								N.W.
	tonnes	F	H	L	P	T	W	HV	a	lbs
8-081-01	1.0	0.98	1.06	2.83	0.71	0.71	3.74	0.28	0.16	1.3
8-081-02	2.0	1.18	1.18	3.35	0.98	0.79	4.53	0.31	0.20	2.2
8-081-03	3.0	1.38	1.18	4.13	1.10	0.91	5.24	0.35	0.24	3.1
8-081-04	4.0	1.65	1.50	4.37	1.10	1.18	5.55	0.39	0.28	4.4
8-081-05	5.0	1.73	1.81	5.20	1.18	1.22	6.57	0.47	0.28	6.6
8-081-08	8.0	1.97	2.13	5.28	1.26	1.54	6.89	0.47	0.31	8.4
8-081-10	10.0	2.20	2.20	6.61	1.73	1.65	8.74	0.51	0.31	13.9
8-081-15	15.0	2.40	2.64	7.24	2.13	1.77	9.49	0.55	0.39	17.4

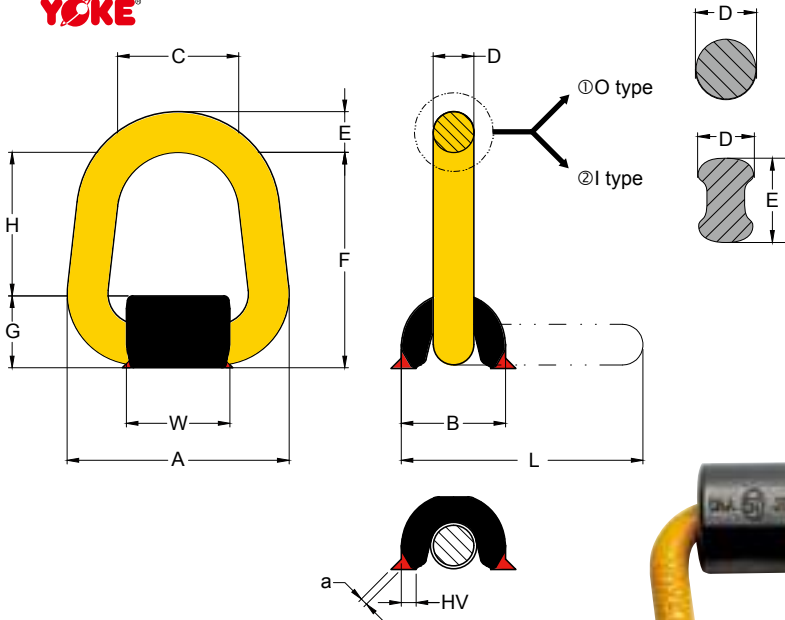

- Pivots through 180°.
- Manufactured from forged alloy steel, quenched and tempered.
- Manufactured and tested in accordance with EN1677-1.
- Load rated parts are 100% magnaflux crack detected.
- Individual forged parts are traceable to Test Certification.
- Proof tested to 2.5 times the WLL.
- All YOKE Lifting points meet or exceed all the requirements of ASME B30.26.
- WLL forged onto each product for quick and easy identification.
- Lugs designed to assist the welding process.
- Never apply load except in the same direction with the pivot direction.

Classic

Classic Weld-on Point without Spring Designed Metric (8-0573)

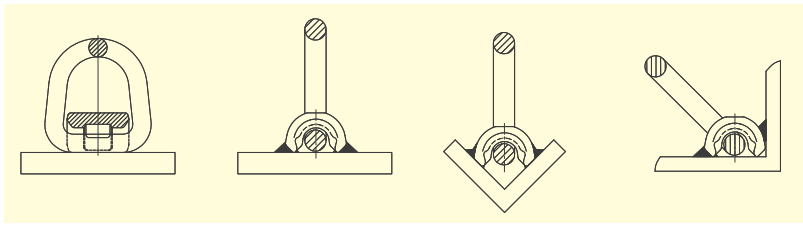

Item No.	Working Load Limit tonnes*	Dimensions (mm)											N.W. kg	
		A	B	C	D	E	F	G	H	L	W	HV		a
① 8-0573-01	1.0	83	41	48	14	14	86	27	58	109	50	5	3	0.5
① 8-0573-03	3.0	98	48	58	17	17	85	31	54	114	58	6	3	0.9
① 8-0573-05	5.0	120	63	66	22	22	118	41	77	157	64	7	3	1.3
① 8-0573-08	8.0	121	73	68	26	26	122	53	69	169	60	10	4	2.4
① 8-0573-10	10.0	146	73	82	20	30	141	53	88	191	75	10	4	2.8
② 8-0573-20	20.0**	186	93	100	25	37	175	70	105	234	91	20	4	6.5
② 8-0573-30	30.0**	254	116	150	35	45	241	84	157	317	127	20	4	17.2

* Design factor 5:1
**Design factor 4:1

Item No.	Working Load Limit lbs*	Dimensions (inch)											N.W. lbs	
		A	B	C	D	E	F	G	H	L	W	HV		a
① 8-0573-01	2200	3.27	1.61	1.89	0.55	0.55	3.39	1.06	2.28	4.29	1.97	0.20	0.12	1.1
① 8-0573-03	6600	3.86	1.89	2.28	0.67	0.67	3.35	1.22	2.13	4.49	2.28	0.24	0.12	2.0
① 8-0573-05	11000	4.72	2.48	2.60	0.87	0.87	4.65	1.61	3.03	6.18	2.52	0.28	0.12	2.9
① 8-0573-08	17600	4.76	2.87	2.68	1.02	1.02	4.80	2.09	2.72	6.65	2.36	0.39	0.16	5.3
① 8-0573-10	22000	5.75	2.87	3.23	0.79	1.18	5.55	2.09	3.46	7.52	2.95	0.39	0.16	6.2
② 8-0573-20	44000**	7.32	3.66	3.94	0.98	1.46	6.89	2.76	4.13	9.21	3.58	0.79	0.16	14.3
② 8-0573-30	66000**	10.00	4.57	5.91	1.38	1.77	9.49	3.31	6.18	12.48	5.00	0.79	0.16	37.8

* Design factor 5:1
**Design factor 4:1

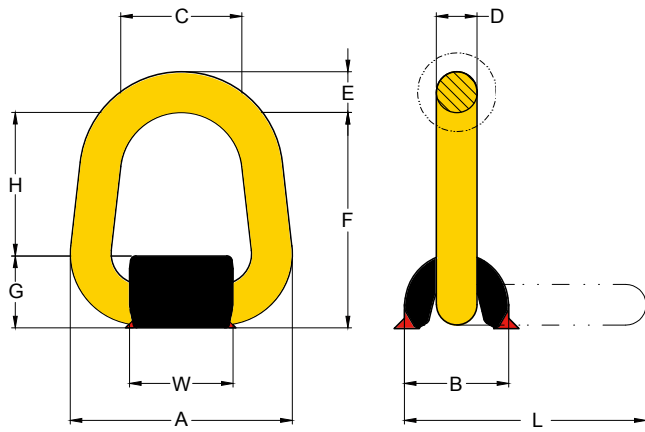

180° Pivot

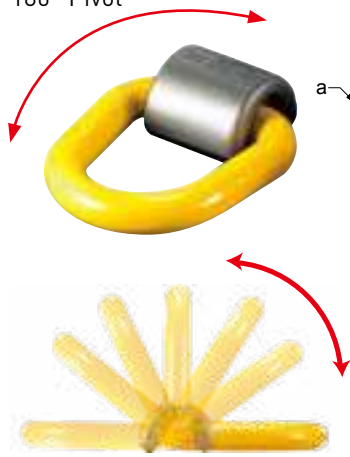

Stop at Any Angle

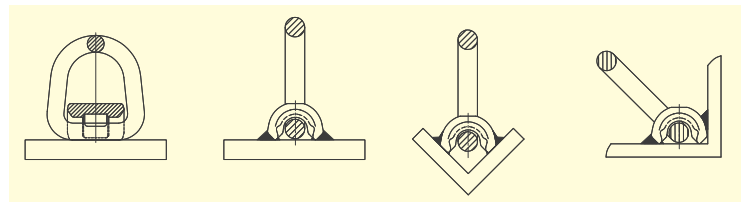

- Pivots through 180°.
- Manufactured from forged alloy steel, quenched and tempered.
- Manufactured and tested in accordance with EN1677-1.
- Load rated parts are 100% magnaflux crack detected.
- Individual forged parts are traceable to Test Certification.
- Proof tested to 2.5 times the WLL.
- All YOKE Lifting points meet or exceed all the requirements of ASME B30.26.
- WLL forged onto each product for quick and easy identification.
- Lugs designed to assist the welding process.
- A protected spring keeps the load ring in a required position. The parts are connected in such a way that they remain captive. The spring also reduces noise caused by vibrations.
- Never apply load except in the same direction with the pivot direction.



Weld-on Point

Designed with spring, stop at any angle

Metric (8-057)

Item No.	Working Load Limit	Dimensions (mm)											N.W.	
		tonnes	A	B	C	D	E	F	G	H	L	W		HV
8-057-1T	1.0	83	41	48	14	14	86	27	58	109	50	5	3	0.5
8-057-3T	3.0	98	48	58	17	17	85	31	54	114	58	6	3	0.9
8-057-5T	5.0	120	63	66	22	22	118	41	77	157	64	7	3	1.3
8-057-8T	8.0	121	73	68	26	26	122	53	69	169	60	10	4	2.6
8-057-10T	10.0	146	73	82	20	30	141	53	88	191	75	10	4	2.8

* Design factor 5:1

Item No.	Working Load Limit	Dimensions (inch)											N.W.	
		lbs	A	B	C	D	E	F	G	H	L	W		HV
8-057-1T	2200	3.27	1.61	1.89	0.55	0.55	3.39	1.06	2.28	4.29	1.97	0.20	0.12	1.1
8-057-3T	6600	3.86	1.89	2.28	0.67	0.67	3.35	1.22	2.13	4.49	2.28	0.24	0.12	2.0
8-057-5T	11000	4.72	2.48	2.60	0.87	0.87	4.65	1.61	3.03	6.18	2.52	0.28	0.12	2.9
8-057-8T	17600	4.76	2.87	2.68	1.02	1.02	4.80	2.09	2.72	6.65	2.36	0.39	0.16	5.7
8-057-10T	22000	5.75	2.87	3.23	0.79	1.18	5.55	2.09	3.46	7.52	2.95	0.39	0.16	6.2

* Design factor 5:1

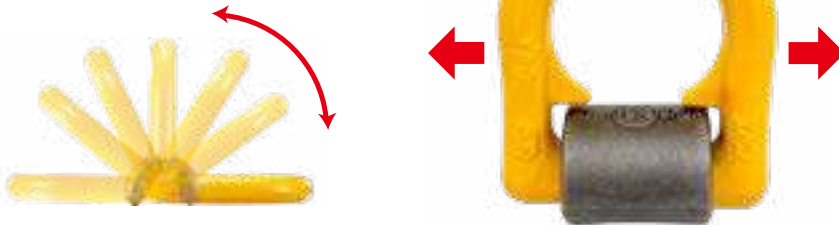
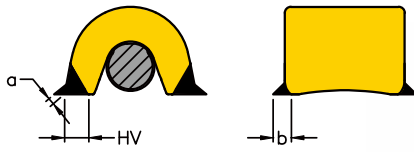
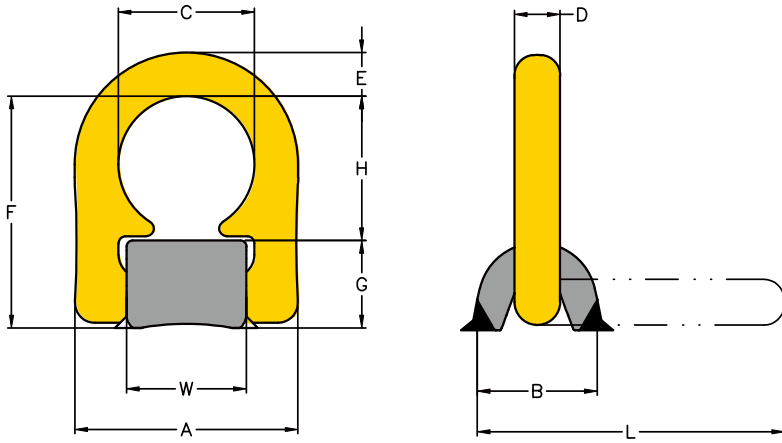

- Load ring pivots 180°.
- Full Loading Capacity in all directions.
- Manufactured from forged alloy steel, quenched and tempered.
- Tested in accordance with EN1677-1.
- 100% magnaflux crack detected.
- Parts individually forged with batch code to ensure full traceability.
- The permitted WLL forged onto each product for quick and easy identification.
- Lugs designed to assist the welding process.
- A protected spring keeps the loading ring in the required position. The parts are connected in such a way that they remain captive. The spring also reduces noise caused by vibrations.

Super Weld-on Point

Metric (8-0575)

Item No.	Working Load Limit tonnes*	Dimensions (mm)											N.W.		
		A	B	C	D	E	F	G	H	L	W	HV	a	b	kg
8-0575-015	1.5	64	31	38	13	13	63	24	39	84	32	5	3	3	0.32
8-0575-025	2.5	74	39	45	16	15	75	28	47	98	39	8	3	3	0.49
8-0575-040	4.0	84	40	51	16	17	81	29	52	108	45	9	3	3	0.67
8-0575-067	6.7	110	60	67	23	22	115	43	72	152	59	12	4	4	1.71
8-0575-100	10.0	122	70	67	27	22	122	51	71	164	59	17	5	7	2.45
8-0575-160	16.0	180	92	100	26	32	172	66	106	228	89	25	6	8	6.33

*Design factor 4:1

Item No.	Working Load Limit lbs*	Dimensions (inch)											N.W.		
		A	B	C	D	E	F	G	H	L	W	HV	a	b	lbs
8-0575-015	3300	2.52	1.22	1.50	0.51	0.51	2.48	0.95	1.54	3.31	1.26	0.20	0.12	0.12	0.70
8-0575-025	5500	2.91	1.54	1.77	0.63	0.59	2.95	1.10	1.85	3.86	1.54	0.32	0.12	0.12	1.08
8-0575-040	8800	3.31	1.58	2.01	0.63	0.67	3.19	1.14	2.05	4.25	1.77	0.35	0.12	0.12	1.47
8-0575-067	14750	4.33	2.36	2.64	0.91	0.87	4.53	1.69	2.84	5.99	2.32	0.47	0.16	0.16	3.76
8-0575-100	22000	4.80	2.76	2.64	1.06	0.87	4.82	2.01	2.79	6.46	2.32	0.67	0.20	0.28	5.39
8-0575-160	35200	7.09	3.62	3.94	1.02	1.26	6.77	2.60	4.17	8.98	3.50	0.98	0.24	0.32	13.93

*Design factor 4:1

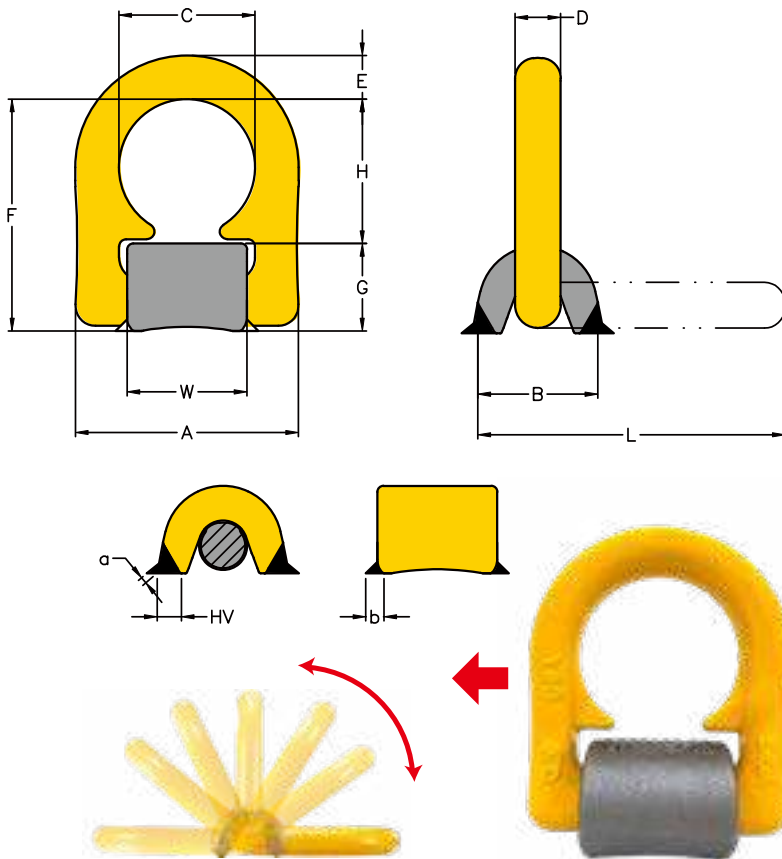

- Lashing ring pivots 180°
- Full Lashing Capacity in all directions.
- Manufactured from forged alloy steel, quenched and tempered.
- Tested in accordance with EN1677-1.
- 100% magnaflux crack detected.
- Parts individually forged with batch code to ensure full traceability.
- The permitted lashing capacity "LC" in daN forged onto each product for quick and easy identification.
- Lugs designed to assist the welding process.
- A protected spring keeps the lashing ring in the required position. The parts are connected in such a way that they remain captive. The spring also reduces noise caused by vibrations.

Lashing Weld-on Point

Metric (8-0576)

Item No.	Lashing Capacity daN	Dimensions (mm)											N.W.		
		A	B	C	D	E	F	G	H	L	W	HV	a	b	kg
8-0576-030	3000	64	31	38	13	13	63	24	39	84	32	5	3	3	0.32
8-0576-050	5000	74	39	45	16	15	75	28	47	98	39	8	3	3	0.49
8-0576-080	8000	84	40	51	16	17	81	29	52	108	45	9	3	3	0.67
8-0576-134	13400	110	60	67	23	22	115	43	72	152	59	12	4	4	1.71
8-0576-200	20000	122	70	67	27	22	122	51	71	164	59	17	5	7	2.45
8-0576-320	32000	180	92	100	26	32	172	66	106	228	89	25	6	8	6.33

*Design factor 2:1

Item No.	Lashing Capacity lbs	Dimensions (inch)											N.W.		
		A	B	C	D	E	F	G	H	L	W	HV	a	b	lbs
8-0576-030	6600	2.52	1.22	1.50	0.51	0.51	2.48	0.95	1.54	3.31	1.26	0.20	0.12	0.12	0.70
8-0576-050	11000	2.91	1.54	1.77	0.63	0.59	2.95	1.10	1.85	3.86	1.54	0.32	0.12	0.12	1.08
8-0576-080	17600	3.31	1.58	2.01	0.63	0.67	3.19	1.14	2.05	4.25	1.77	0.35	0.12	0.12	1.47
8-0576-134	29500	4.33	2.36	2.64	0.91	0.87	4.53	1.69	2.84	5.99	2.32	0.47	0.16	0.16	3.76
8-0576-200	44000	4.80	2.76	2.64	1.06	0.87	4.82	2.01	2.79	6.46	2.32	0.67	0.20	0.28	5.39
8-0576-320	70400	7.09	3.62	3.94	1.02	1.26	6.77	2.60	4.17	8.98	3.50	0.98	0.24	0.32	13.93

*Design factor 2:1

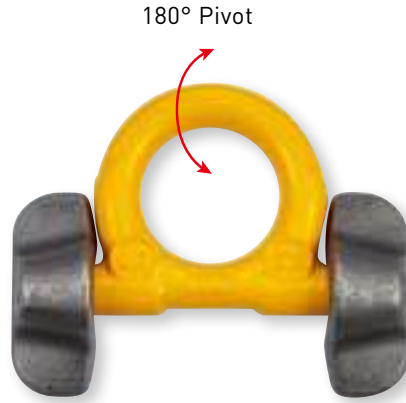
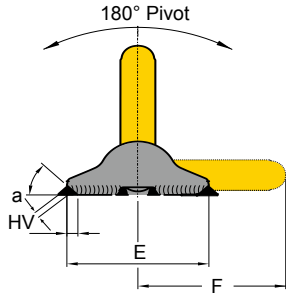
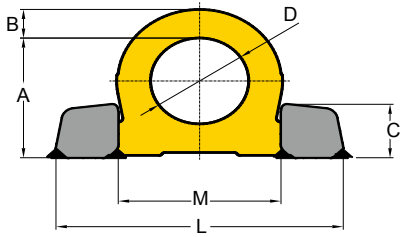

- Pivots 180°, designed minimizes head room.
- Manufactured from forged alloy steel, quenched and tempered.
- Tested and certified by DGUV GS-0A-15-04.
- Load rated parts are 100% magnaflux crack detected.
- Individual forged parts are traceable to Test Certification.
- Proof tested to 2.5 times the WLL.
- The two points of attachment facilitate an even and optimal force distribution into the work piece and thus, usage of thinner base plates is possible.
- The welding block is forged out of material with excellent welding properties.
- Low profile design with high strength.
- The ring is stowable thus avoiding the hazards of tripping and snagging.



Weld-on Ring

Metric (8-082)

Item No.	Working Load Limit tonnes	Dimensions (mm)										N.W. kg
		A	B	C	D	E	F	L	M	HV	a	
8-082-04	4.0	66	14	30	48	65	70	135	76	5	3	0.6
8-082-06	6.7	85	20	39	60	89	91	171	98	5	3	1.5
8-082-10	10.0	95	21	46	65	100	100	196	106	7	4	2.4
8-082-16	16.0	127	30	57	90	130	136	263	149	8	4	5.5
8-082-30	31.5	178	42	75	130	160	195	375	213	15	4	15.8

* Design factor 4:1

Item No.	Working Load Limit tonnes	Dimensions (inch)										N.W. lbs
		A	B	C	D	E	F	L	M	HV	a	
8-082-04	4.0	2.60	0.55	1.18	1.89	2.56	2.76	5.31	2.99	0.20	0.1	1.3
8-082-06	6.7	3.35	0.79	1.54	2.36	3.50	3.58	6.73	3.86	0.20	0.1	3.3
8-082-10	10.0	3.74	0.83	1.81	2.56	3.94	3.94	7.72	4.17	0.28	0.2	5.3
8-082-16	16.0	5.00	1.18	2.24	3.54	5.12	5.35	10.35	5.87	0.31	0.2	12.1
8-082-30	31.5	7.01	1.65	2.95	5.12	6.30	7.68	14.76	8.39	0.59	0.2	34.8

* Design factor 4:1

BlueSupra™

Supra Digital Chips





TECH FOR SAFETY



Supra Series, Robust Digital Chips

The use of plastic Digital Chips in a severe offshore working environment can lead to the loss or corruption of data, especially when the plastic chip is subject to continuous impact damage, UV from sunlight, corrosion, oil pollution and other mechanical damage experienced when working in challenging conditions.

The application of the Supra Series can avoid this risk.

Features:

- NFC enabled mobile device or smart phone (iOS 14 or greater required/ Android 12 or greater required) can be used as reader.
- Corrosion resistant stainless steel.
- Meet the requirement of US Military Standard MIL-STD-810H.
- Meet IK10 impact protection level.
- Meet Highest IP68 rating of dust and water resistance.
- Unique design of proprietary wafer-antenna chip construction.
- Patents in several countries.
- By using the Supra Digital Chips with a third-party asset management application to achieve product traceability, manufacturer authentication and digitized product information.



SupraTag
Compliance

Patent Number

- | | |
|----------------------------------|-------------------------------------|
| » United States Patent: 10235617 | » Taiwan Patent: M573545 |
| » Japan Patent: 3219858 | » China Patent: ZL 201821589819.6 |
| | » Japan Patent: 3219858 |
| » United States Patent: 10607128 | » United States Patent: 10607128 |
| » Japan Patent: 3220091 | |
| | » German Patent: 602018032891.2 |
| | » Italy Patent: 3627396 |
| | » UK Patent: 10607128 |
| | » Taiwan Patent: I638765 |
| | » China Patent: ZL 2017 1 0821524.0 |
| | » United States Patent: 10235617 |

Compliant



NFC Enabled

Item No. 13243 SupraTag

universal use

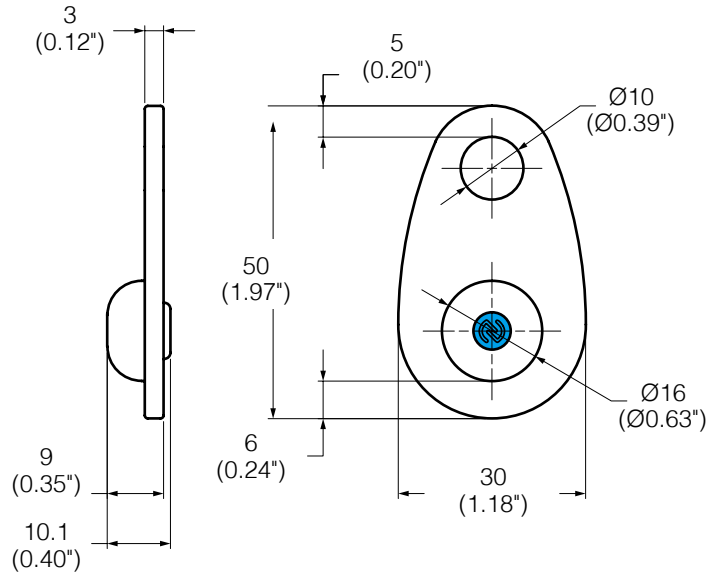

mm (inch)
weight: 33g (1.16oz)



NFC Enabled

Functionality

RF Protocol	ISO 15693
Operating Frequency	HF - 13.56 MHz
Memory Configuration	16 Character UID, 2000 bits User
R/W Capability	Read / Write

Performance

Read Range	Maximum to 5 mm [0.2"]
Quality Guarantee	100 %
Orientation	Front Face Read
IP Rating	IP68

Physical

Quality Guarantee	PA 6 + 30 GF
Mounting System	Universal Use
Color	Tag : Turquoise Blue Plate & Housing : Polished

Operational

Max Temperature Exposure	125 °C / 257 °F
Min Temperature Exposure	-30 °C / -22 °F
Continuous Max Service Temperature	125 °C / 257 °F
Continuous Min Service Temperature	-30 °C / -22 °F
Water and Ice Proof	Yes

Item No. 13271 SupraDC 271

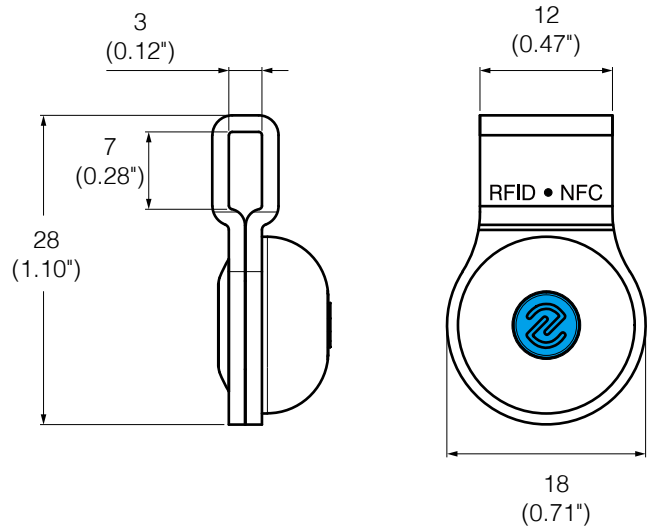

mm (inch)
weight: 17.5g (0.62oz)



NFC Enabled

Item No. 13273 SupraDC 273

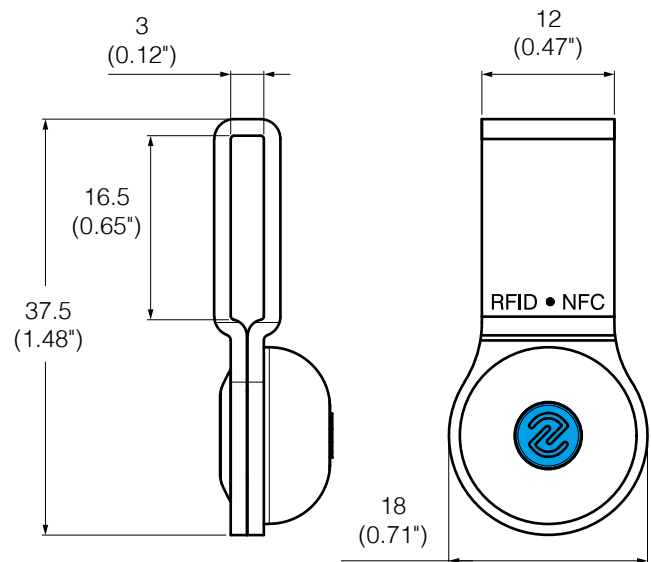

mm (inch)
weight: 20g (0.71oz)



NFC Enabled

Item No. 13285 SupraDC 285

Chain Sling Tag, Aluminium.

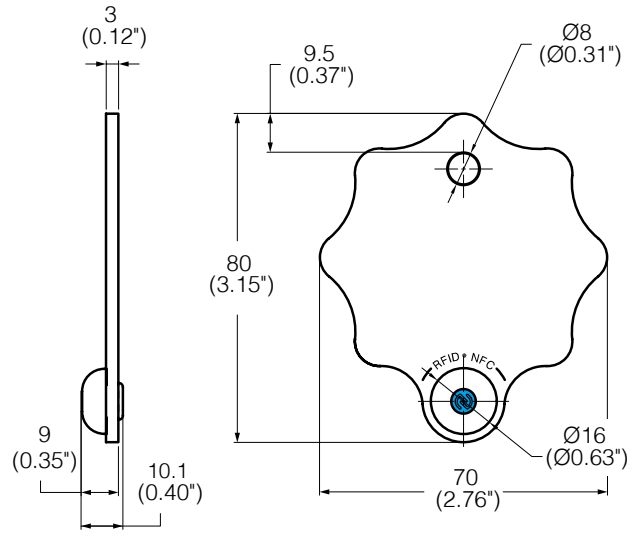
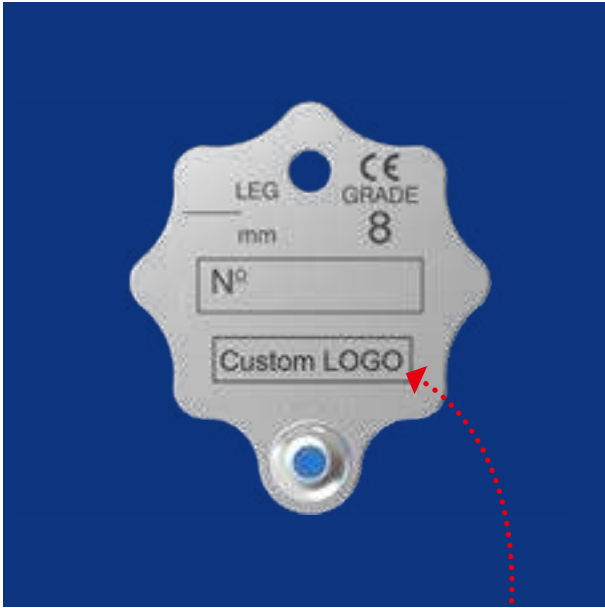

mm (inch)
weight: 35.3g (1.25oz)



NFC Enabled

Custom Logo

Item No. 13288 SupraDC 288

Chain Sling Tag, Aluminium.

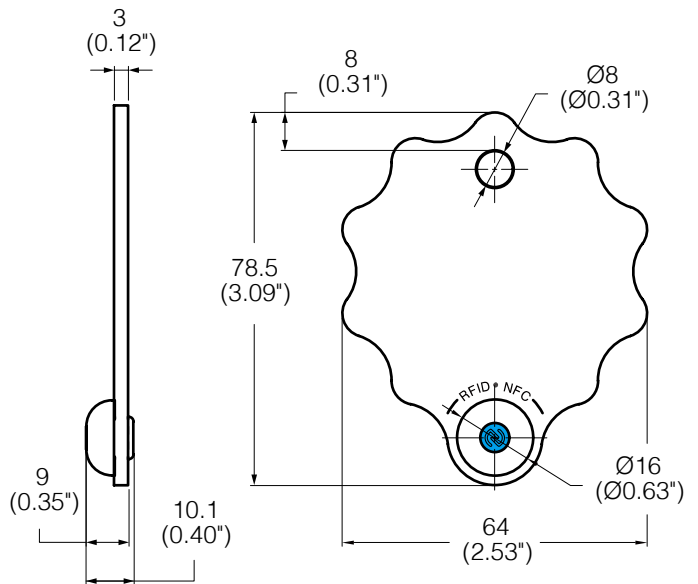

mm (inch)
weight: 34g (1.2oz)



NFC Enabled

Custom Logo

Item No. 13287 SupraDC 287

for wire rope sling, Aluminium.

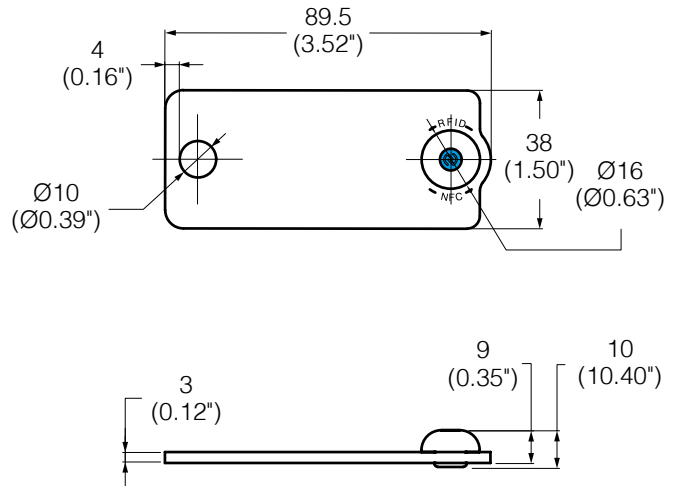
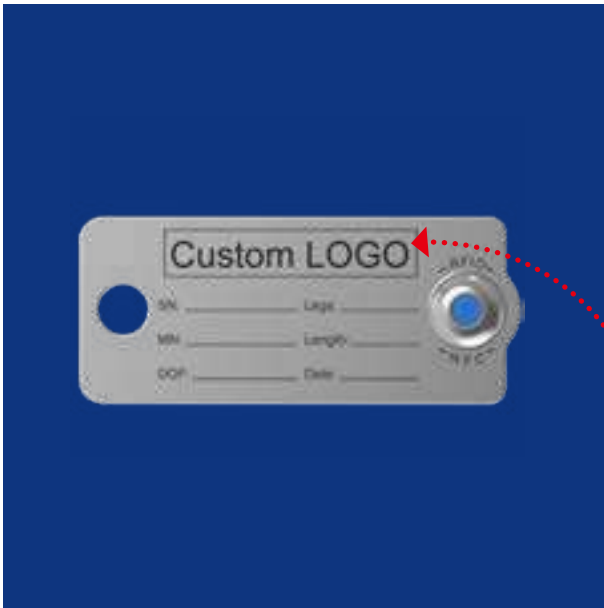

mm (inch)
weight: 33g (1.16oz)



NFC Enabled

Custom Logo

Item No. 13281 SupraDC 281

for chain sling, Aluminium.

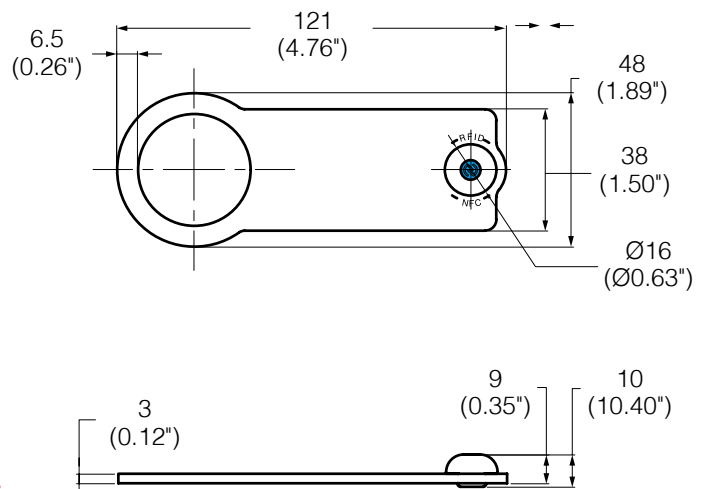
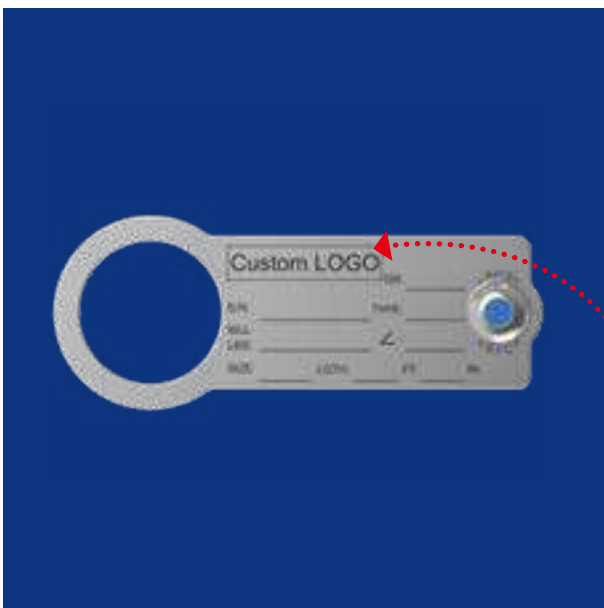

mm (inch)
weight: 36.2g (1.28oz)



NFC Enabled

Custom Logo

Item No. 13234 SupraDC 234

Application: PPE Fall protection Full body Harness.

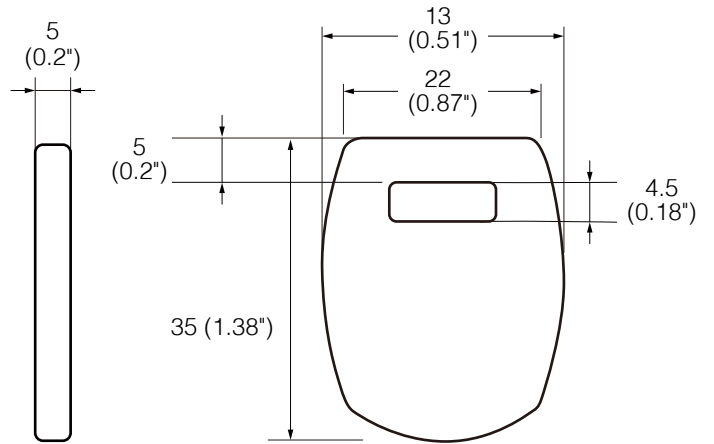

mm (inch)
weight: 2.1g (0.07oz)



NFC Enabled





Supra Series Digital Chips

The use of plastic Digital Chips in a severe offshore working environment can lead to the loss or corruption of data, especially when the plastic chip is subject to continuous impact damage, UV from sunlight, corrosion, oil pollution and other mechanical damage experienced when working in challenging conditions.

The application of the Supra Series can avoid this risk.

Features:

- NFC enabled mobile device or smart phone (iOS 14 or greater required/ Android 12 or greater required) can be used as reader.
- Patents in several countries.
- By using the Supra Digital Chips with a third-party asset management application to achieve product traceability, manufacturer authentication and digitized product information.

Functionality	
RF Protocol	ISO 15693
Operating Frequency	HF - 13.56 MHz
Memory Configuration	16 Character UID, 2000 bits User
R/W Capability	Read / Write
Performance	
Read Range	Maximum to 5 mm [0.2"]
Quality Guarantee	100 %
Orientation	Front Face Read
IP Rating	IP68
Physical	
Quality Guarantee	PA 6 + 30 GF
Mounting System	Universal Use
Color	Yellow
Operational	
Max Temperature Exposure	125 °C / 257 °F
Min Temperature Exposure	-30 °C / -22 °F
Continuous Max Service Temperature	125 °C / 257 °F
Continuous Min Service Temperature	-30 °C / -22 °F
Water and Ice Proof	Yes



BlueSupra™

Supra Digital Chips

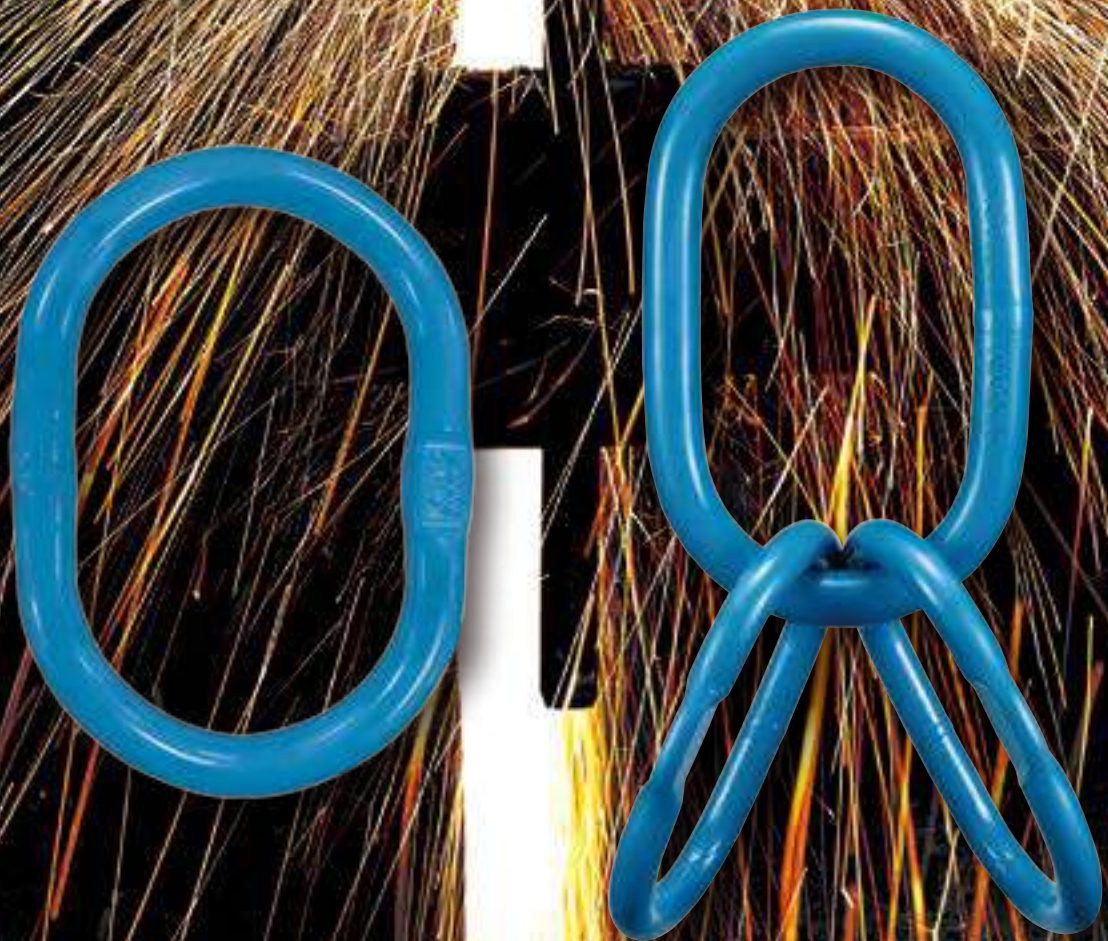

EX **TREME-100**





DANGER: Overhead lifting presents a very real danger of severe injury or loss of life if lifting equipment is not used properly. Please read and understand all of these instructions prior to using any lifting sling or sling assembly. Sling should only be used by qualified persons who are responsible for the sling selection, inspection and use.

Grade 100 Chain Sling Components

WORKING LOAD LIMITS IN TONNES acc. to PAS 1061						
Load Factor	1	1.4	1	2.1	1.5	1.6
For Chain Size mm	tonnel	β 0 - 45° α 0 - 90°	45° - 60° 90° - 120°	β 0 - 45° α 0 - 90°	45° - 60° 90° - 120°	
6	1.4	2.0	1.4	2.9	2.1	2.2
7	1.9	2.7	1.9	4.0	2.9	3.0
8	2.5	3.5	2.5	5.3	3.8	4.0
10	4.0	5.6	4.0	8.4	6.0	6.4
13	6.7	9.4	6.7	14.1	10.1	10.7
16	10.0	14.0	10.0	21.0	15.0	16.0
20	16.0	22.4	16.0	33.6	24.0	25.6
22	19.0	26.5	19.0	39.9	28.5	30.4
26	26.5	37.1	26.5	55.7	39.8	42.4
32	40.0	56.0	40.0	84.0	60.0	64.0

**Safety factor 4:1 above limits are valid for standard use and equally loaded slings. Properly use and maintainance of your YOKE chain slings will give long life and enable you to carry out your lifting operations efficiently and safely.

Warning: Never exceed a vertical sling angle of 60°

SAFE USE

- Never load in excess of the rated capacity for the application.
- Keep a record of all slings in use.
- User should remove all twists from a chain leg before lifting and, should never knot a chain.
- Always use YOKE shortening hook or clutch when chain slings should be shortened.
- Always inspect to insure that chain is free from damage or wear before use.
- Always inspect all sling components prior to each use.
- Ensure that chain is protected from any sharp corners on the load.
- Ensure that the master link articulates freely on the hook of the crane or other lifting appliance.
- Never tip load hooks. The load should always be supported correctly in the bowl of the hook.
- Always use the correct size sling for the load, allowing for the included angle and the possibility of unequal loading.
- Personnel must keep all body parts from between the sling and the load, and from between the sling and the crane/hoist hook. Persons shall never ride the chain sling/rope sling or web sling or the load during lifting or while suspended. Persons must stand clear of all loads while lifting or while suspended. During lifting, with or without the load, personnel must be alert for possible snagging of the load or the chain sling.

MAINTENANCE

- A thorough examination should be carried out by a competent person at intervals at least every year or more frequently according to statutory regulations, type of use and past records.
- Chains with bent links or with cracks or gouges in the link should be replaced, as should deformed components such as bent master links, deformed hooks and any fittings showing signs of damage.
- Chain and components wear should never exceed 10% of the original dimensions.
- Once a chain sling has been overloaded it must be taken out of service.
- Store chain slings on a properly designed rack. They should not be left lying on the floor where they may suffer mechanical or corrosion damage or may be lost.

LIMITATION ON USE

- YOKE alloy chain or chain slings should not be used in acid or caustic solutions nor in heavily acidic or caustic laden atmospheres. The high tensile strength of the heat treated alloy material in alloy steel chains and components is susceptible to hydrogen embrittlement when exposed to acids.
- YOKE slings must not be heat-treated, galvanized, plated, coated or subject to any process involving heating or pickling. Each of these processes can have dangerous effects and will invalidate the manufacturer certificate.
- YOKE slings may be used at temperatures between -40°C to 200°C with no reduction in the working load limit. The use of YOKE chain slings within the permissible temperature range in the table below does not require any permanent reduction in working load limit when the chain sling is returned to normal temperatures. A sling accidentally exposed to temperatures in excess of the maximum permissible should be withdrawn from service immediately and returned to the distributor for thorough examination.
- When using YOKE slings in exceptionally hazardous conditions, the degree of hazard should be assessed by a competent person and the Working Load Limit adjusted accordingly. Examples are lifting of potentially dangerous loads such as molten metals, corrosive materials or fissile material and including certain offshore activities.

Sling temperature (F)	Sling temperature (C)	Reduction in Working Load Limit
-40°F to 400°F	-40°C to 200°C	None
400°F to 550°F	200°C to 300°C	10%
550°F to 750°F	300°C to 400°C	25%
Above 750°F	Above 400°C	Do not use.

Examples Of Chain Slings

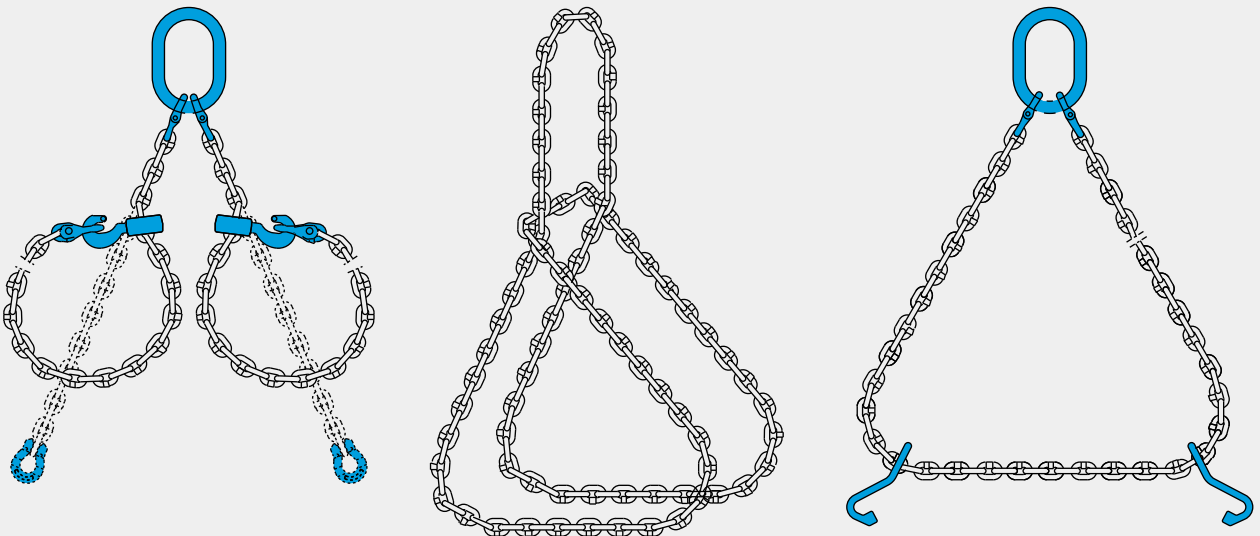
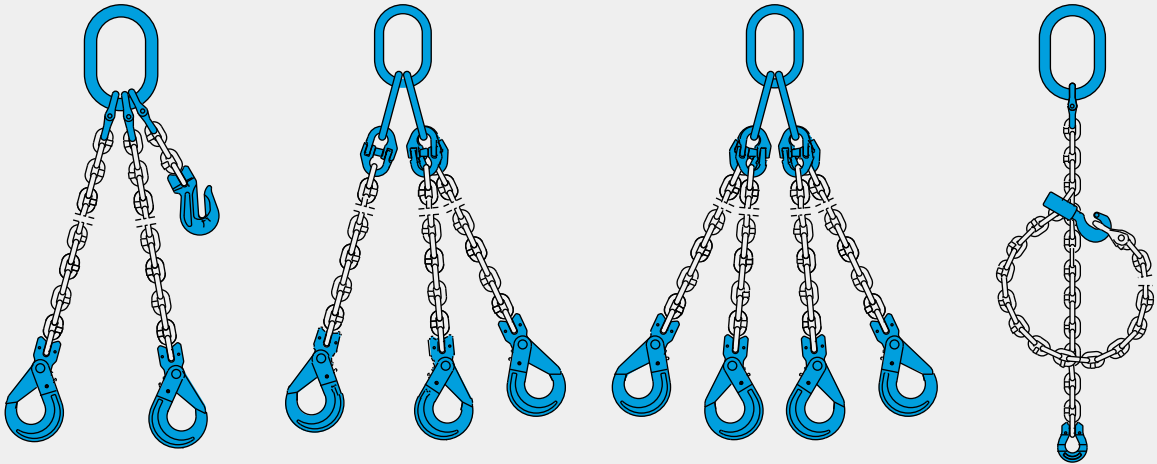
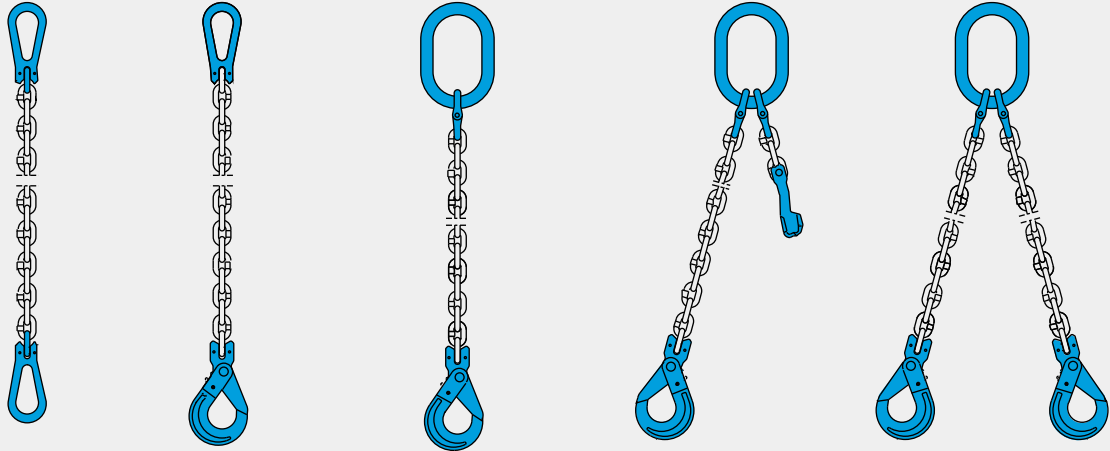

Examples Of Wire Rope Sling & Web Sling

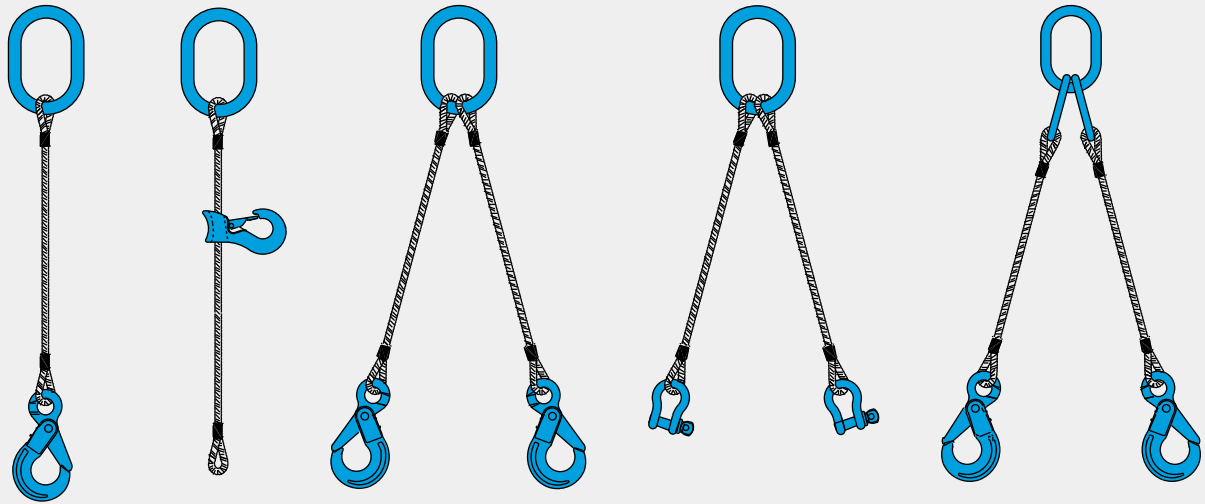

Incorrect Use

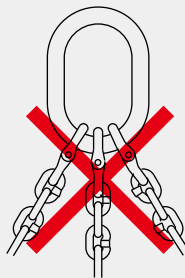
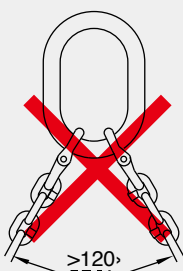
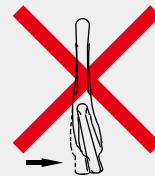
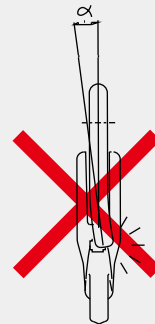
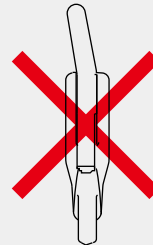
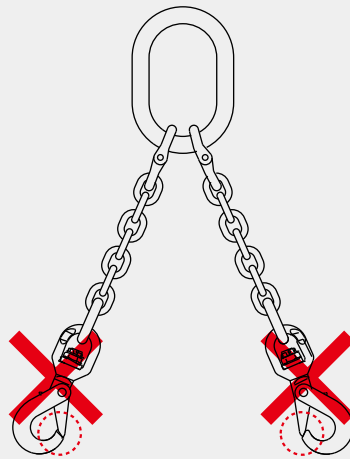
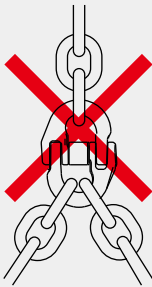
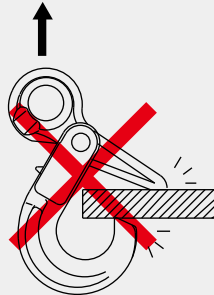
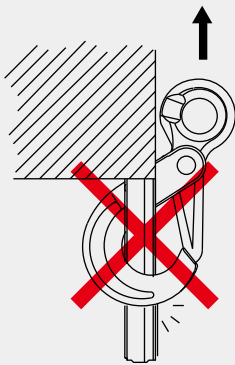
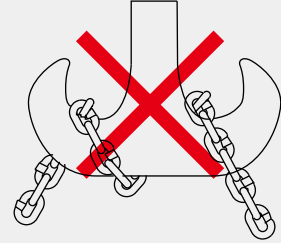
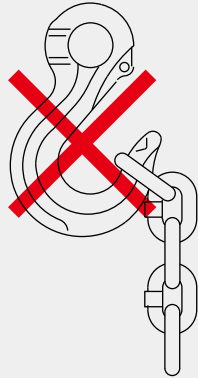

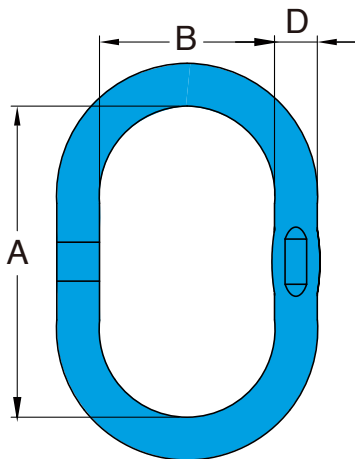

- Quenched and Tempered Alloy Steel.
- At least 25% greater WLL than traditional G80 products.
- Manufactured in accordance with ASTM A952/A952M, ASME B30.9, ASME B30.26, EN 1677-4 and OSHA 1910.184.
- Certified by DGUV GS-0A-15-05.
- Proof Load tested at 2.5 times the WLL with certification for each batch manufactured.
- Design Factor 5:1.
- Fatigue rated to 20,000 cycles at 1.5 times the WLL.
- Tempering temperature at a minimum of 400°C.
- Welded Master Link designed for 1-2 legs Chain, Wire Rope and Webbing Slings.
- Each link is marked with batch number that links to the test certificate with full traceability to raw materials.



X-001 Welded Master Link

Item No.	Code No.	For Grade 100 Chain (mm)		WLL B 0-45° tonnes	Proof Load kN	Used to single hook according to DIN 15401 No.	Dimensions (mm)			N.W. kg
		1-leg	2-leg				D	A	B	
X-001-13	AD-13	6,7,8	6	2.8	69	2.5	13	120	60	0.4
X-001-16	AD-16	10	7,8	4.0	98	6.0	16	160	90	0.7
X-001-19	AD-19	13	10	6.7	164	6.0	19	160	90	1.1
X-001-22	AD-22	13	10	8.9	208	8.0	22	180	100	1.6
X-001-25	AD-25	16	13	11.5	282	10.0	25	210	115	2.4
X-001-251	AD-251	16	13	11.5	282	16.0	25	275	145	3.1
X-001-28	AD-28	16	13	13.0	319	16.0	28	275	145	3.9
X-001-281	AD-281	16	13	13.0	319	8.0	28	190	100	2.8
X-001-32	AD-32	20	16	17.1	417	16.0	32	275	145	5.1
X-001-36	AD-36	22	20	24.0	588	20.0	36	285	155	6.9
X-001-40	AD-40	26	22	28.1	688	20.0	40	300	160	8.9
X-001-45	AD-45	26	26	38.3	938	25.0	45	340	180	12.8
X-001-50	AD-50	32	26	45.0	1103	32.0	50	350	195	16.6

Sub-links SPEC for X-007. Items in grey area are not for sale individually.

X-001-161	AD-161	10	7,8	4.0	98	-	16	140	70	0.6
X-001-361	AD-361	22	20	24.0	588	-	36	275	145	6.6
X-001-401	AD-401	26	22	28.1	688	-	40	260	130	7.8
X-001-601	AD-601	32	32	65.0	1593	-	60	410	220	27.9
X-001-701	AD-701	-	-	85.0	2083	-	70	400	200	37.7

★ Design factor 5:1 proof tested and certified.

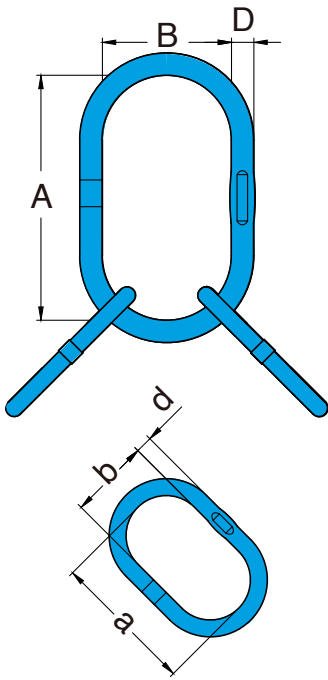

- Quenched and Tempered Alloy Steel.
- At least 25% greater WLL than traditional G80 products.
- Manufactured in accordance with ASTM A952/A952M, ASME B30.9, ASME B30.26, EN 1677-4 and OSHA 1910.184.
- Certified by DGUV GS-0A-15-05.
- Proof Load tested at 2.5 times the WLL with certification for each batch manufactured.
- Design Factor 5:1.
- Fatigue rated to 20,000 cycles at 1.5 times the WLL.
- Tempering temperature at a minimum of 400°C.
- Welded Master Link designed for 3-4 legs Chain, Wire Rope and Webbing Slings.
- Each link is marked with batch number that links to the test certificate with full traceability to raw materials.



X-007 Welded Master Link Assembly

Item No.	Assembled with	For	WLL	Proof	Used to single hook	Dimensions (mm)						N.W.
		Grade 100				B 0-45°	Load	according to	D	A	B	
		Chain (mm)	tonnes	kN	DIN 15401 No.							
X-007-19	AD-19 +2 AD-161	7,8	5.3	130	6	19	160	90	16	140	70	2.4
X-007-25	AD-251+2 AD-19	10	8.9	218	16	25	275	145	19	160	90	5.2
X-007-28	AD-28 +2 AD-22	10	12.9	316	16	28	275	145	22	180	100	7.1
X-007-32	AD-32 +2 AD-25	13	17.0	417	16	32	275	145	25	210	115	10.0
X-007-36	AD-361+2 AD-281	16	23.6	578	16	36	275	145	28	190	100	12.2
X-007-40	AD-40 +2 AD-32	16	28.1	688	20	40	300	160	32	275	145	19.2
X-007-45	AD-45 +2 AD-36	20	38.3	938	25	45	340	180	36	285	155	26.5
X-007-50	AD-50 +2 AD-401	22	45.0	1103	32	50	350	195	40	260	130	33.9

★Design factor 5:1 proof tested and certified.

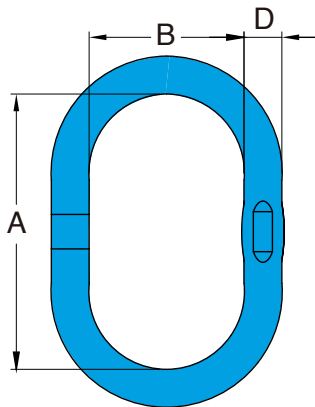

- Quenched and Tempered Alloy Steel.
- At least 25% greater WLL than traditional G80 products.
- Manufactured in accordance with ASTM A952/A952M, ASME B30.9, ASME B30.26, EN 1677-4 and OSHA 1910.184.
- Proof Load tested at 2.5 times the WLL with certification for each batch manufactured.
- Design Factor 4:1.
- Fatigue rated to 20,000 cycles at 1.5 times the WLL.
- Tempering temperature at a minimum of 400°C.
- Welded Master Link designed for 1-2 legs Chain, Wire Rope and Webbing Slings.
- Each link is marked with batch number that links to the test certificate with full traceability to raw materials.

X-002 Welded Master Link

Item No.	Code No.	For Grade 100 Chain (mm)		WLL B 0-45° tonnes	Proof Load kN	Used to single hook according to DIN 15401 No.	Dimensions (mm)			N.W. kg
		1-leg	2-leg				D	A	B	
X-002-13	BD-13	7,8	6	2.8	69	2.5	13	110	60	0.30
X-002-16	BD-16	10	7,8	4.0	98	2.5	16	110	60	0.50
X-002-19	BD-19	13	10	6.7	164	5.0	19	135	75	0.90
X-002-22	BD-22	13	10	8.5	208	6.0	22	160	90	1.50
X-002-28	BD-28	16	13	11.5	282	8.0	28	180	100	2.70
X-002-32	BD-32	20	16	17.0	417	10.0	32	200	110	3.90
X-002-36	BD-36	22	20	25.1	615	16.0	36	260	140	6.30
X-002-45	BD-45	26	22	38.3	938	25.0	45	300	180	11.80
X-002-50	BD-50	32	26	45.0	1103	32.0	50	300	200	15.20

★Design factor 4:1 proof tested and certified.

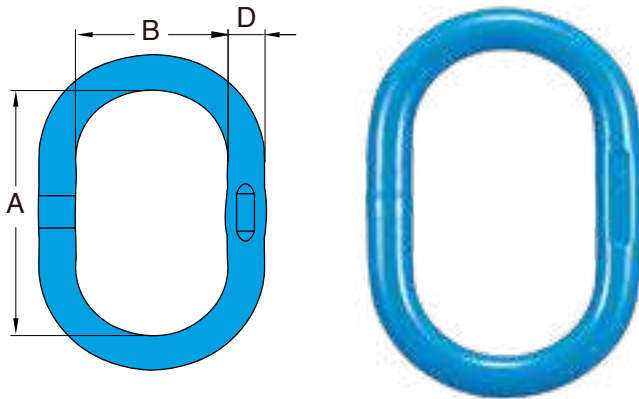

- Quenched and Tempered Alloy Steel.
- At least 25% greater WLL than traditional G80 products.
- Manufactured in accordance with ASTM A952/A952M, ASME B30.9, ASME B30.26, EN 1677-4 and OSHA 1910.184.
- Proof Load tested at 2.5 times the WLL with certification for each batch manufactured.
- Design Factor 4:1.
- Fatigue rated to 20,000 cycles at 1.5 times the WLL.
- Tempering temperature at a minimum of 400°C.
- Welded Master Link designed for 1-2 legs Chain, Wire Rope and Webbing Slings.
- Each link is marked with batch number that links to the test certificate with full traceability to raw materials.

X-002W Welded Master Link

Item No.	Code No.	For Grade 100 Chain (mm)		WLL Ø 0-45° tonnes	Proof Load kN	Used to single hook according to DIN 15401 No.	Dimensions (mm)			N.W. kg
		1-leg	2-leg				D	A	B	
X-002W-13	CD-13	7,8	6	2.8	69	4	13	120	70	0.4
X-002W-16	CD-16	10	7,8	4.0	98	5	16	140	80	0.7
X-002W-19	CD-19	13	10	6.7	164	6	19	160	95	1.1
X-002W-22	CD-22	13	10	8.5	208	10	22	170	105	1.6
X-002W-28	CD-28	16	13	11.5	282	10	28	190	110	2.9
X-002W-32	CD-32	20	16	17.0	417	12	32	230	130	4.5
X-002W-36	CD-36	22	20	25.1	615	20	36	275	150	6.7

★Design factor 4:1 proof tested and certified.

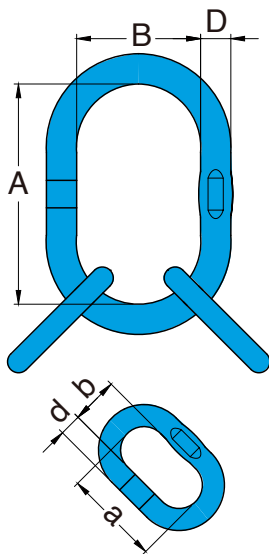

- Quenched and Tempered Alloy Steel.
- At least 25% greater WLL than traditional G80 products.
- Manufactured in accordance with ASTM A952/A952M, ASME B30.9, ASME B30.26, EN 1677-4 and OSHA 1910.184.
- Proof Load tested at 2.5 times the WLL with certification for each batch manufactured.
- Design Factor 4:1.
- Fatigue rated to 20,000 cycles at 1.5 times the WLL.
- Tempering temperature at a minimum of 400°C.
- Welded Master Link designed for 3-4 legs Chain, Wire Rope and Webbing Slings.
- Each link is marked with batch number that links to the test certificate with full traceability to raw materials.

X-006 Welded Master Link Assembly

Item No.	Assembled with	For	WLL	Proof	Used to single hook	Dimensions (mm)						N.W.	
		Grade 100				B 0-45°	Chain (mm)	tonnes	kN	according to DIN	15401 No.		D
X-006-19	BD-19 +2 DD-13	6	4.2	103	5	19	135	75	13	54	25	1.3	
X-006-22	BD-22 +2 DD-16	7,8	8.2	201	6	22	160	90	16	70	34	2.2	
X-006-28	BD-28 +2 DD-19	10	10.7	262	8	28	180	100	19	85	40	3.9	
X-006-32	BD-32 +2 DD-22	13	15.7	385	10	32	200	110	22	115	50	6.1	
X-006-36	BD-36 +2 DD-28	16	22.2	544	16	36	260	140	28	140	65	10.6	
X-006-50	BD-50 +2 DD-32	20	34.1	835	32	50	300	200	32	150	70	21.2	
X-006-501	BD-50 +2 DD-36	22	40.0	980	32	50	300	200	36	170	75	23.8	

★Design factor 4:1 proof tested and certified.

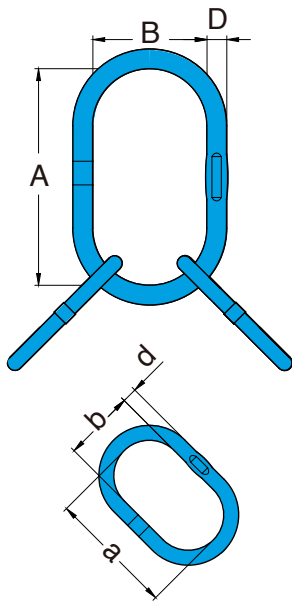

- Quenched and Tempered Alloy Steel.
- At least 25% greater WLL than traditional G80 products.
- Manufactured in accordance with ASTM A952/A952M, ASME B30.9, ASME B30.26, EN 1677-4 and OSHA 1910.184.
- Proof Load tested at 2.5 times the WLL with certification for each batch manufactured.
- Design Factor 4:1.
- Fatigue rated to 20,000 cycles at 1.5 times the WLL.
- Tempering temperature at a minimum of 400°C.
- Welded Master Link designed for 3-4 legs Chain, Wire Rope and Webbing Slings.
- Each link is marked with batch number that links to the test certificate with full traceability to raw materials.

X-006L Welded Master Link Assembly

Item No.	Assembled with	For	WLL	Proof	Used to single hook	Dimensions (mm)						N.W.
		Grade 100				B 0-45°	Load	according to DIN	D	A	B	
		Chain (mm)	tonnes	kN	15401 No.							
X-006L-19	BD-19 +2 BD-13	6	4.2	103	5	19	135	75	13	110	60	1.6
X-006L-22	BD-22 +2 BD-16	7,8	8.2	201	6	22	160	90	16	110	60	2.5
X-006L-32	BD-32 +2 BD-22	10	10.7	262	10	32	200	110	22	160	90	6.9
X-006L-36	BD-36 +2 BD-28	13	15.7	385	16	36	260	140	28	180	100	11.8
X-006L-45	BD-45 +2 BD-32	16	22.2	544	25	45	300	180	32	200	110	19.7

★Design factor 4:1 proof tested and certified.

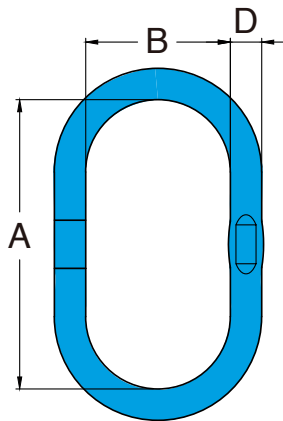

- Quenched and Tempered Alloy Steel.
- At least 25% greater WLL than traditional G80 products.
- Manufactured in accordance with ASTM A952/A952M, ASME B30.9, ASME B30.26, EN 1677-4 and OSHA 1910.184.
- Proof Load tested at 2.5 times the WLL with certification for each batch manufactured.
- Design Factor 4:1.
- Fatigue rated to 20,000 cycles at 1.5 times the WLL.
- Tempering temperature at a minimum of 400°C.
- Welded Master Link designed for 1 leg Chain, Wire Rope and Webbing Slings.
- Each link is marked with batch number that links to the test certificate with full traceability to raw materials.

X-0080 Welded Master Link

Item No.	Code No.	For	WLL	Proof	Used to single hook	Dimensions (mm)			N.W.
		Grade 100				Ø 0-45°	Load	according to DIN 15401	
		Chain (mm)	tonnes	kN					
X-0080-28	ED-28	13	6.7	164	25	28	340	180	4.7
X-0080-32	ED-32	16	10.0	245	25	32	340	180	6.2
X-0080-40	ED-40	20,22	19.0	466	25	40	340	180	10.0

★Design factor 4:1 proof tested and certified.

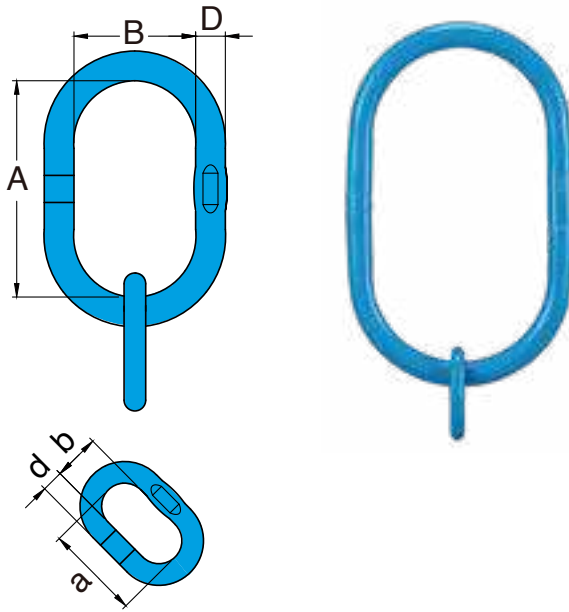

- Quenched and Tempered Alloy Steel.
- At least 25% greater WLL than traditional G80 products.
- Manufactured in accordance with ASTM A952/A952M, ASME B30.9, ASME B30.26, EN 1677-4 and OSHA 1910.184.
- Proof Load tested at 2.5 times the WLL with certification for each batch manufactured.
- Design Factor 4:1.
- Fatigue rated to 20,000 cycles at 1.5 times the WLL.
- Tempering temperature at a minimum of 400°C.
- Welded Master Link designed for 1 leg Chain, Wire Rope and Webbing Slings.
- Each link is marked with batch number that links to the test certificate with full traceability to raw materials.

X-0081 Welded Master Link Assembly

Item No.	Assembled with	For	WLL	Proof	Used to single hook	Dimensions (mm)						N.W.
		Grade 100				B 0-45°	Load	according to DIN 15401	No.			
		Chain (mm)	tonnes	kN	No.	D	A	B	d	a	b	kg
X-0081-22	ED-22 +1 DD-13	6,7,8	2.5	61	25	22	340	180	13	54	25	3.2
X-0081-28	ED-28 +1 DD-16	10	4.0	98	25	28	340	180	16	70	34	5.4

★Design factor 4:1 proof tested and certified.

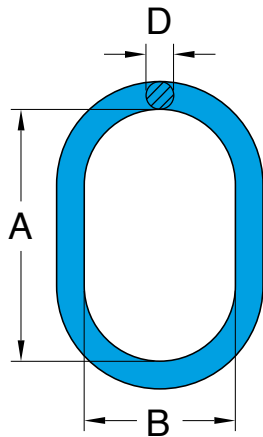

Forged

- Quenched and Tempered Alloy Steel.
- At least 25% greater WLL than traditional G80 products.
- Manufactured in accordance with ASTM A952/A952M, ASME B30.9, ASME B30.26, EN 1677-4 and OSHA 1910.184.
- Proof Load tested at 2.5 times the WLL with certification for each batch manufactured.
- Design Factor 4:1.
- Fatigue rated to 20,000 cycles at 1.5 times the WLL.
- Tempering temperature at a minimum of 400°C.
- Designed for 1-2 legs Chain, Wire Rope and Webbing Slings.
- Each link is marked with batch number that links to the test certificate with full traceability to raw materials.

X-003 Forged Oblong Master Link

Item No.	For Grade 100 Chain (mm)		WLL 8 0-45° tonnes	Proof Load kN	Used to single hook according to DIN 15401 No.	Dimensions (mm)			N.W. kg
	1-leg	2-leg				D	A	B	
X-003-06	6	-	1.4	34	2.5	11	100	60	0.2
X-003-0806	7,8	6	2.9	71	4.0	14	120	70	0.5
X-003-1008	10	7, 8	5.3	130	5.0	17	140	80	0.7
X-003-13	13	-	6.7	164	6.0	19	150	90	1.1
X-003-1310	13	10	8.4	206	6.0	22	160	95	1.5
X-003-16	16	-	10.0	245	10.0	25	190	110	2.3
X-003-1613	16	13	14.1	345	8.0	28	180	105	2.7
X-003-19	19,20	-	16.0	392	10.0	30	200	120	3.5
X-003-2216	22	16	21.0	515	16.0	34	240	140	5.3
X-003-26	26	-	26.5	649	16.0	38	250	150	7.4
X-003-2619	26	19, 20	33.6	823	16.0	40	250	150	8.3
X-003-3222	32	22	39.9	978	25.0	45	300	180	12.3

★ Design factor 4:1 proof tested and certified.

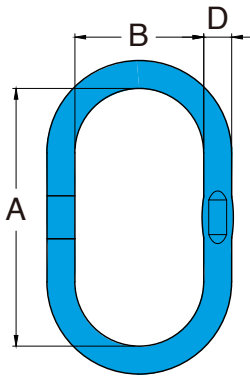

- Quenched and Tempered Alloy Steel.
- At least 25% greater WLL than traditional G80 products.
- Manufactured in accordance with ASTM A952/A952M, ASME B30.9, ASME B30.26 ,EN 1677-4, and OSHA 1910.184.
- Proof Load tested at 2.5 times the WLL with certification for each batch manufactured.
- Design Factor 4:1.
- Fatigue rated to 20,000 cycles at 1.5 times the WLL.
- Tempering temperature at a minimum of 400°C.
- Welded Master Link designed for 1-2 legs Chain, Wire Rope and Webbing Slings.
- Each link is marked with batch number that links to the test certificate with full traceability to raw materials.

X-004 Welded Master Link

Sub-links SPEC for X-0081 Items in grey area are not for sale individually.

Item No.	Code No.	For Grade 100 Chain (mm)		WLL 8 0-45° tonnes	Proof Load kN	Dimensions (mm)			N.W. kg
		1-leg	2-leg			D	A	B	
X-004-13	DD-13	10	6	4.0	98	13	54	25	0.2
X-004-16	DD-16	13	7,8	6.7	164	16	70	34	0.4
X-004-19	DD-19	16	10	10.0	245	19	85	40	0.6
X-004-22	DD-22	20	13	14.0	343	22	115	50	1.1
X-004-28	DD-28	22	16	19.0	466	28	140	65	2.1
X-004-32	DD-32	26	20	26.5	649	32	150	70	3.0
X-004-36	DD-36	-	22	31.0	760	36	170	75	4.3
X-004-40	DD-40	32	-	40.4	990	40	170	80	5.5
X-004-45	DD-45	-	26	42.4	1039	45	170	80	7.1
X-004-50	DD-50	-	32	64.0	1568	50	200	100	10.3

★Design factor 4:1 proof tested and certified.

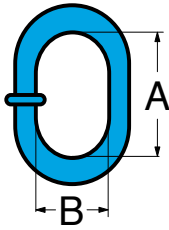

- Quenched and Tempered Alloy Steel.
- At least 25% greater WLL than traditional G80 chain
- Manufactured in accordance with EN 818-2
- Proof Load tested at 2.5 times the WLL
- Design Factor 4:1
- Temperature application range -20° up to 200°C
- Marked with grade (10) and batch number that links to the test certificate with full traceability to raw material.
- Blue painted surface finish.

Grade 100 Lifting Chain

Item No.	Chain Dia mm	Working Load Limit tonnes*	Dimensions		Length Per Carton meters	N.W. kg Per m
			A mm	B mm		
X-009-06	6	1.4	18	8.5	1,200	0.6
X-009-08	8	2.5	24	10.4	800	1.1
X-009-10	10	4.0	30	13.0	500	2.2
X-009-13	13	6.7	39	16.9	300	3.7
X-009-16	16	10.0	48	20.8	200	6.0

★ Design factor 4:1 proof tested and certified.
Tested Acc. to EN 818

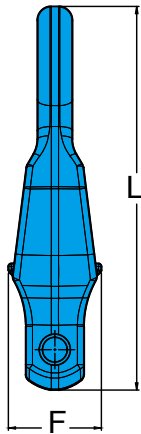
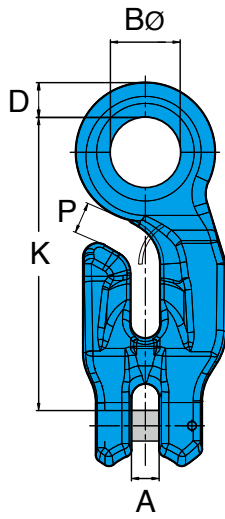

- Quenched and Tempered Alloy Steel.
- At least 25% greater WLL than traditional G80 products.
- Manufactured in accordance with DIN EN 1677-1 and DIN 5692.
- Proof Load tested at 2.5 times the WLL with certification for each batch manufactured.
- Design Factor 4:1
- Fatigue rated to 20,000 cycles at 1.5 times the WLL.
- Tempering temperature at a minimum of 400°C.
- Each hook is marked with batch number that links to the test certificate with full traceability to raw materials.

G-100 Eye Grab Hook

Item No.	WLL tonnes	For Grade 100 Chain mm	Dimensions (mm)							N.W. kg
			A	B	D	F	K	L	P	
X-079-06	1.4	6	8	18	9	24	76	99	12	0.24
X-079-07	2.5	7, 8	10	24	13	32	102	134	12	0.54
X-079-10	4.0	10	12	31	14	40	125	163	15	1.03
X-079-13	6.7	13	16	37	18	51	158	208	20	2.18
X-079-16	10.0	16	19	48	24	64	202	264	21	4.39

★Design factor 4:1 proof tested and certified.

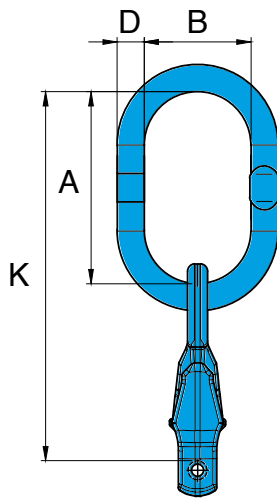

- Quenched and Tempered Alloy Steel.
- At least 25% greater WLL than traditional G80 products.
- Manufactured in accordance with EN 1677 and ASTM A952/ A 952M.
- Proof Load tested at 2.5 times the WLL with certification for each batch manufactured.
- Design Factor 4:1.
- Fatigue rated to 20,000 cycles at 1.5 times the WLL.
- Tempering temperature at a minimum of 400°C.
- Each link is marked with batch number that links to the test certificate with full traceability to raw materials.
- Fully integrated shortening clutch and master link.
- No reduction in WLL when shortening chain.
- Speedy assembly.
- Light weight system.
- Cost effective compared to slings which use multiple components.



G100 Single Leg Assembly

Item No.	WLL	For Grade 100 Chain	Can be used on single hook Acc. To DIN15401 No.	Dimensions (mm)				N.W.
	tonnes			mm	D	A	B	
X-A04-06	1.4	6	4	13	120	70	196	0.7
X-A04-08	2.5	7,8	5	16	140	80	242	1.2
X-A04-10	4.0	10	6	19	160	95	285	2.1
X-A04-13	6.7	13	10	22	170	105	328	3.9
X-A04-16	10.0	16	10	28	190	110	392	7.0

★Design factor 4:1 proof tested and certified.

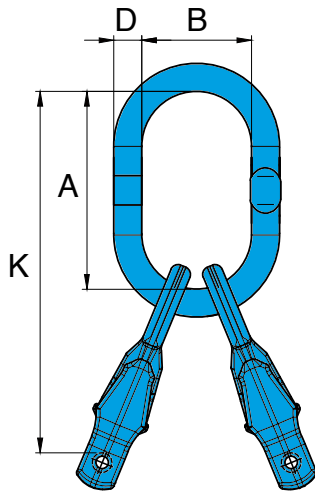

- Quenched and Tempered Alloy Steel.
- At least 25% greater WLL than traditional G80 products.
- Manufactured in accordance with EN 1677 and ASTM A952/ A 952M.
- Proof Load tested at 2.5 times the WLL with certification for each batch manufactured.
- Design Factor 4:1.
- Fatigue rated to 20,000 cycles at 1.5 times the WLL.
- Tempering temperature at a minimum of 400°C.
- Each link is marked with batch number that links to the test certificate with full traceability to raw materials.
- Fully integrated shortening clutch and master link.
- No reduction in WLL when shortening chain.
- Speedy assembly.
- Light weight system.
- Cost effective compared to slings which use multiple components.



G100 2 Leg Assembly

Item No.	WLL tonnes	For Grade 100 Chain mm	Can be used on single hook Acc. To DIN15401 No.	Dimensions				N.W. kg
				D	A	B	K	
X-A05-06	2.0	6	4	13	120	70	196	0.9
X-A05-08	3.5	7,8	6	19	160	95	262	2.2
X-A05-10	5.6	10	10	22	170	105	295	3.8
X-A05-13	9.4	13	10	28	190	110	348	7.0
X-A05-16	14.0	16	12	32	230	130	432	13.6

★Design factor 4:1 proof tested and certified.

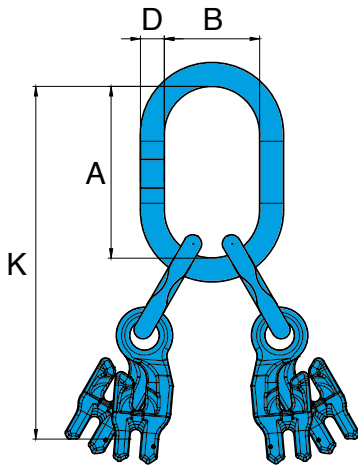

- Quenched and Tempered Alloy Steel.
- At least 25% greater WLL than traditional G80 products.
- Manufactured in accordance with EN 1677 and ASTM A952/ A 952M.
- Proof Load tested at 2.5 times the WLL with certification for each batch manufactured.
- Design Factor 4:1.
- Fatigue rated to 20,000 cycles at 1.5 times the WLL.
- Tempering temperature at a minimum of 400°C.
- Each link is marked with batch number that links to the test certificate with full traceability to raw materials.
- Fully integrated shortening clutch and master link.
- No reduction in WLL when shortening chain.
- Speedy assembly.
- Light weight system.
- Cost effective compared to slings which use multiple components

G100 4 Leg Assembly

Item No.	WLL tonnes	For Grade 100 Chain mm	Can be used on single hook Acc. To DIN15401 No.	Dimensions (mm)				N.W. kg
				D	A	B	K	
X-A06-06	2.9	6	6	19	160	95	290	2.4
X-A06-08	5.3	7,8	10	22	170	105	342	4.6
X-A06-10	8.4	10	10	28	190	110	400	8.1
X-A06-13	14.1	13	12	32	230	130	503	15.8
X-A06-16	21.0	16	20	36	275	150	617	28.9

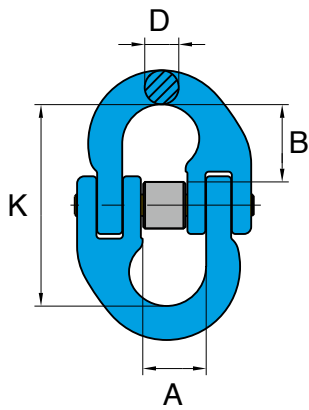

- Quenched and Tempered Alloy Steel.
- At least 25% greater WLL than traditional G80 products.
- Manufactured in accordance with EN 1677- 1 and ASTM A952/ A952M.
- Certified by DGUV GS-0A-15-05
- Proof Load tested at 2.5 times the WLL with certification for each batch manufactured.
- Design Factor 4:1.
- Fatigue rated to 20,000 cycles at 1.5 times the WLL.
- Suitable for use with both Grade 80 and Grade 100 chain.

G-100 Connecting Link

Item No.	For Grade 100 Chain	WLL tonnes*	Dimensions (mm)				N.W. kg
	mm		A	B	D	K	
X-015-06	6	1.4	15	17	7	45	0.08
X-015-07	7, 8	2.5	18	23	9	59	0.20
X-015-10	10	4.0	25	27	11	69	0.30
X-015-13	13	6.7	30	37	16	92	0.70
X-015-16	16	10.0	36	39	19	101	1.20
X-015-20	20	16.0	42	46	23	122	2.10
X-015-22	22	19.0	49	59	24	152	3.50
X-015-26	26	26.5	55	62	30	162	4.80
X-015-32	32	40.0	69	79	36	203	9.00

★ Design factor 4:1 proof tested and certified.

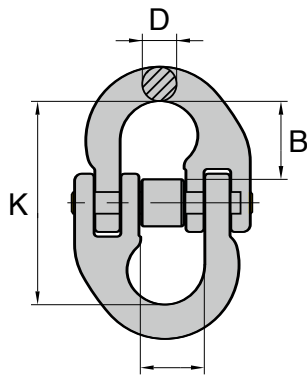

- Quenched and Tempered Alloy Steel.
- At least 25% greater WLL than traditional G80 products.
- Manufactured in accordance with EN 1677- 1 and ASTM A952/ A952M.
- Proof Load tested at 2.5 times the WLL with certification for each batch manufactured.
- Design Factor 4:1.
- Fatigue rated to 20,000 cycles at 1.5 times the WLL.
- Suitable for use with both Grade 80 and Grade 100 chain.
- Dacromet surface finish for enhanced corrosion resistance.

G-100 Connecting Link

Dacromet® surface finish**

Item No.	For Grade 100 Chain	WLL tonnes*	Dimensions (mm)				N.W. kg
	mm		A	B	D	K	
X-M015-06	6	1.4	15	18	7	45	0.10
X-M015-07	7, 8	2.5	18	25	9	59	0.20
X-M015-10	10	4.0	25	28	11	69	0.30
X-M015-13	13	6.7	30	38	16	92	0.70
X-M015-16	16	10.0	36	41	19	101	1.20
X-M015-20	20	16.0	42	49	23	122	2.10
X-M015-22	22	19.0	49	63	24	152	3.50
X-M015-26	26	26.5	55	66	30	162	4.80
X-M015-32	32	40.0	69	87	36	203	9.00

★ Design factor 4:1 proof tested and certified.

Safety Triggers



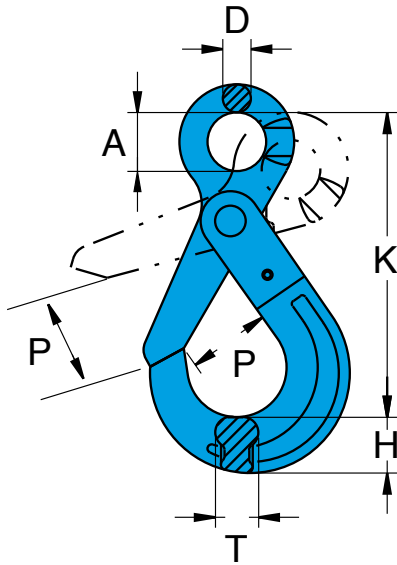

- Quenched and Tempered Alloy Steel.
- At least 25% greater WLL than traditional G80 products.
- Manufactured in accordance with EN 1677- 3 and ASME B30.26, ASME B30.10.
- Certified by DGUV GS-0A-15-05.
- Proof Load tested at 2.5 times the WLL with certification for each batch manufactured.
- Design Factor 4:1.
- Fatigue rated to 20,000 cycles at 1.5 times the WLL.
- Tempering temperature minimum 400°C
- Magnaflux crack detection is performed 100% on each batch.

G-100 Eye Self Locking Hook

Item No.	For Grade 100 Chain	WLL tonnes*	Dimensions (mm)						N.W. kg
	mm		A	D	H	K	P	T	
X-025-06	6	1.4	21	10	19	110	28	15	0.5
X-025-07	7,8	2.5	25	11	24	136	34	20	0.8
X-025-10	10	4.0	32	13	30	167	44	26	1.5
X-025-13	13	6.7	40	16	39	207	51	30	3.0
X-025-16	16	10.0	50	21	49	252	60	36	5.8
X-025-20	20	16.0	60	23	65	293	70	53	10.0
X-025-22	22	19.0	70	24	63	319	80	49	12.5
X-025-26	26	26.5	80	25	69	343	99	56	15.0

★ Design factor 4:1 proof tested and certified.

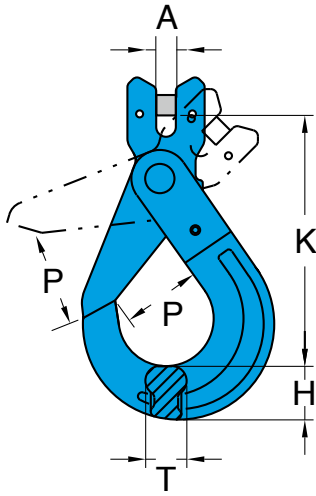

- Quenched and Tempered Alloy Steel.
- At least 25% greater WLL than traditional G80 products.
- Manufactured in accordance with EN 1677- 3 and ASME B30.26, ASME B30.10, PAS1061.
- Certified by DGUV GS-0A-15-05
- Proof Load tested at 2.5 times the WLL with certification for each batch manufactured.
- Design Factor 4:1.
- Fatigue rated to 20,000 cycles at 1.5 times the WLL.
- Tempering temperature minimum 400°C
- Magnaflux crack detection is performed 100% on each batch.

G-100 Clevis Self Locking Hook

Item No.	For Grade 100 Chain	WLL tonnes*	Dimensions (mm)					N.W. kg
	mm		A	H	K	P	T	
X-026-06	6	1.4	7	19	94	28	15	0.4
X-026-07	7,8	2.5	9	24	119	34	20	0.9
X-026-10	10	4.0	11	30	142	44	26	1.4
X-026-13	13	6.7	15	39	178	52	30	3.0
X-026-16	16	10.0	18	49	213	60	36	5.0
X-026-20	20	16.0	25	65	251	70	53	11.0
X-026-22	22	19.0	24	63	273	80	49	13.5

★ Design factor 4:1 proof tested and certified.

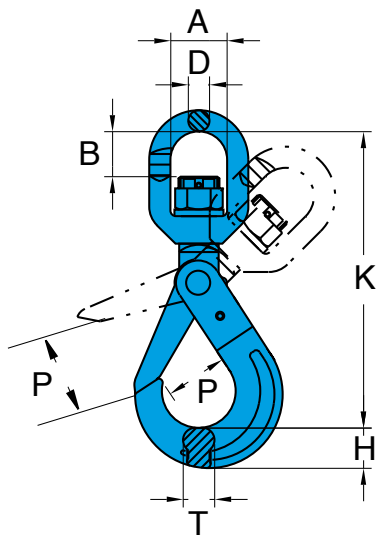

- Quenched and Tempered Alloy Steel.
- At least 25% greater WLL than traditional G80 products.
- Manufactured in accordance with EN 1677- 3 and ASME B30.26, ASME B30.10, PAS1061.
- Certified by DGUV GS-0A-15-05.
- Proof Load tested at 2.5 times the WLL with certification for each batch manufactured.
- Design Factor 4:1.
- Fatigue rated to 20,000 cycles at 1.5 times the WLL.
- Tempering temperature minimum 400°C
- Magnaflux crack detection is performed 100% on each batch.

G-100 Swivel Self Locking Hook

With Brass Bushing

Item No.	For Grade 100 Chain	WLL tonnes*	Dimensions (mm)							N.W. kg
	mm		A	B	D	H	K	P	T	
X-027-06	6	1.4	32	25	12	19	149	28	15	0.7
X-027-07	7,8	2.5	36	30	13	24	186	34	20	1.2
X-027-10	10	4.0	41	38	16	30	218	44	26	2.0
X-027-13	13	6.7	46	48	21	39	276	51	30	4.1
X-027-16	16	10.0	61	56	23	49	329	60	36	7.2
X-027-20	20	16.0	74	86	25	65	403	70	53	13.0
X-027-22	22	19.0	97	98	33	63	454	80	49	20.0
X-027-26	26	26.5	123	120	51	69	535	99	56	33.0

★ Design factor 4:1 proof tested and certified.

⚠ WARNING INFORMATION : This hook is a positioning device and is not intended to rotate under load. For swivel hooks designed to rotate under load, see X-027N.

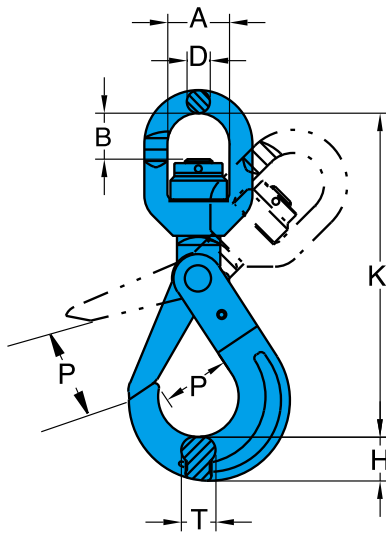

- Quenched and Tempered Alloy Steel.
- At least 25% greater WLL than traditional G80 products.
- Manufactured in accordance with EN 1677- 3 and ASME B30.26, ASME B30.10, PAS1061.
- Certified by DGUV GS-0A-15-05
- Proof Load tested at 2.5 times the WLL with certification for each batch manufactured.
- Design Factor 4:1.
- Fatigue rated to 20,000 cycles at 1.5 times the WLL.
- Tempering temperature minimum 400°C
- Magnaflux crack detection is performed 100% on each batch.
- Built with ball bearing and enables full swivel feature under load.

G-100 Swivel Self Locking Hook

with Ball Bearing, which performs full swivel under load.

Item No.	For Grade 100 Chain	WLL tonnes*	Dimensions (mm)							N.W. kg
	mm		A	B	D	H	K	P	T	
X-027N-06	6	1.4	32	23	12	19	149	28	15	0.7
X-027N-07	7,8	2.5	36	29	13	24	186	34	20	1.2
X-027N-10	10	4.0	41	35	16	30	218	44	26	2.0
X-027N-13	13	6.7	46	44	21	39	276	51	30	4.1
X-027N-16	16	10.0	61	50	23	49	329	60	36	7.2
X-027N-20	20	16.0	74	82	25	65	403	70	53	13.0
X-027N-22	22	19.0	97	96	33	63	454	80	49	20.0
X-027N-26	26	26.5	123	116	51	69	535	99	56	33.0

★ Design factor 4:1 proof tested and certified.

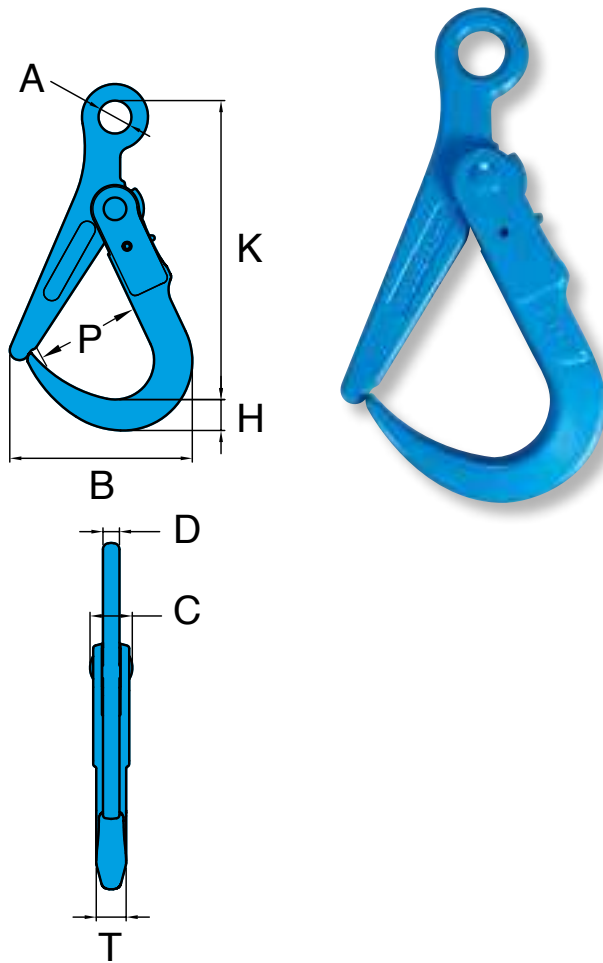

- Quenched and Tempered Alloy Steel.
- Proof Load tested at 2.5 times the WLL with certification for each batch manufactured.
- Design Factor 5:1.
- Fatigue rated to 20,000 cycles at 1.5 times the WLL.
- Tempering temperature minimum 400°C
- Magnaflux crack detection is performed 100% on each batch.

G-100 Super Lock Hook

Item No.	WLL tonnes*	Dimensions (mm)								N.W. kg
		A	B	C	D	H	K	P	T	
X-019-02	2.0	32	177	41	16	30	290	108	29	3.5
X-019-03	3.0	32	177	41	16	30	290	108	29	3.5

★ Design factor 5:1 proof tested and certified.

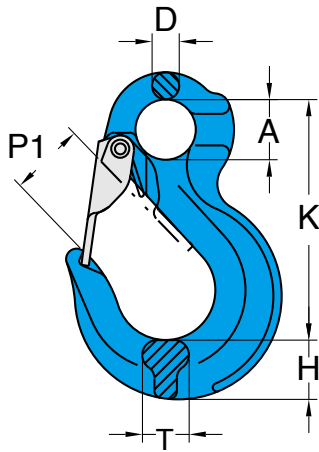

- Quenched and Tempered Alloy Steel.
- At least 25% greater WLL than traditional G80 products.
- Manufactured in accordance with EN 1677- 2 and ASME B30.26, ASME B30.10, PAS1061.
- Certified by DGUV GS-0A-15-05
- Proof Load tested at 2.5 times the WLL with certification for each batch manufactured.
- Design Factor 4:1.
- Fatigue rated to 20,000 cycles at 1.5 times the WLL.
- Tempering temperature minimum 400°C
- Magnaflux crack detection is performed 100% on each batch.

G-100 Eye Sling Hook with Latch

Item No.	For Grade 100 Chain	WLL tonnes*	Dimensions (mm)						N.W. kg
	mm		A	D	H	K	P1	T	
X-044/S-06	6	1.4	20	10	19	80	23	17	0.3
X-044/S-07	7,8	2.5	25	12	22	98	28	20	0.5
X-044/S-10	10	4.0	33	15	30	122	36	23	1.0
X-044/S-13	13	6.7	40	18	38	152	40	28	1.8
X-044/S-16	16	10.0	51	22	44	185	44	36	3.4
X-044/S-20	20	16.0	61	27	64	230	54	48	7.3
X-044/S-22	22	19.0	51	31	61	245	76	52	9.3
X-044/S-26	26	26.5	65	34	77	285	77	61	13.5
X-044/S-32	32	40.0	91	41	79	358	114	65	22.0

★ Design factor 4:1 proof tested and certified.

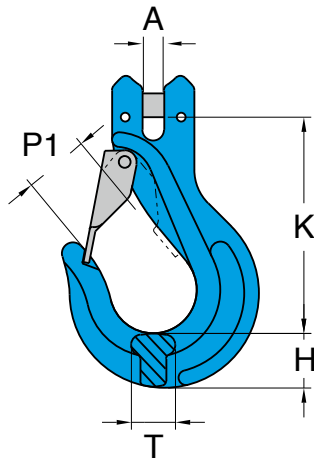

- Quenched and Tempered Alloy Steel.
- At least 25% greater WLL than traditional G80 products.
- Manufactured in accordance with EN 1677- 2 and ASME B30.26, ASME B30.10, PAS1061.
- Certified by DGUV GS-0A-15-05
- Proof Load tested at 2.5 times the WLL with certification for each batch manufactured.
- Design Factor 4:1.
- Fatigue rated to 20,000 cycles at 1.5 times the WLL.
- Tempering temperature minimum 400°C
- Magnaflux crack detection is performed 100% on each batch.

G-100 Clevis Sling Hook with Latch

Item No.	For Grade 100 Chain	WLL tonnes*	Dimensions (mm)					N.W. kg
	mm		A	H	K	P1	T	
X-043/S-06	6	1.4	7	18	79	23	15	0.3
X-043/S-07	7,8	2.5	9	22	98	27	18	0.6
X-043/S-10	10	4.0	12	30	122	34	24	1.1
X-043/S-13	13	6.7	15	37	147	44	30	2.3
X-043/S-16	16	10.0	17	41	166	48	39	3.8
X-043/S-20	20	16.0	24	64	207	57	48	8.7
X-043/S-22	22	19.0	25	61	217	75	52	9.5

★ Design factor 4:1 proof tested and certified.

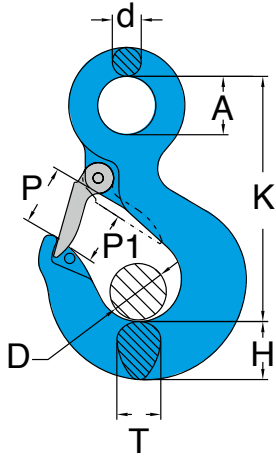

- Quenched and Tempered Alloy Steel.
- Proof Load tested at 2 times of 5:1 WLL with certification for each batch manufactured.
- Fatigue rated to 20,000 cycles at 1.5 times of 5:1 WLL.
- Magnaflux crack detection is performed 100% on each batch.
- YOKE Eye Hoist Hooks are Predrilled to accept a YOKE latch kits.

Alloy Eye Hoist Hook with Latch

Item No.	Hook Feature Code	Working Load Limit	Dimensions (mm)								N.W. kg
			5:1	A	D	d	H	K	P	P1	
8-173-01	AA	1.0	23	22	10	19	83	26	22	15	0.3
8-173-015	BB	1.5	23	19	11	22	95	23	19	17	0.4
8-173-02	CC	2.0	29	20	13	27	106	24	20	22	0.7
8-173-03	DD	3.0	32	25	15	29	122	28	25	24	0.9
8-173-05	EE	5.0	41	31	18	37	149	36	31	31	2.0
8-173-07	FF	7.0	51	38	24	48	192	42	39	37	4.0
8-173-11	GG	11.0	63	57	28	56	233	61	60	47	7.0
8-173-15	HH	15.0	73	62	32	64	260	68	62	52	9.4
8-173-22	JJ	22.0	90	81	40	74	318	92	81	68	18.7
8-173-30	KK	30.0	90	83	45	93	357	89	83	76	31.3

★ Design factor 5:1 proof tested and certified.

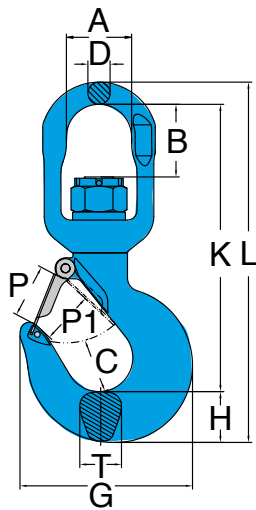

- Quenched and Tempered Alloy Steel.
- Proof Load tested at 2 times of 5:1 WLL with certification for each batch manufactured.
- Fatigue rated to 20,000 cycles at 1.5 times of 5:1 WLL.
- Magnaflux crack detection is performed 100% on each batch.
- YOKE Swivel Hoist Hooks are Predrilled to accept a YOKE latch kits.

Alloy Swivel Hoist Hook with Brass Washer

Item No.	Hook Feature Code	Working Load Limit mm	Dimensions (mm)										N.W. kg	
			A	B	C	D	G	H	K	L	P	P1		T
8-175-01	AA	1.0	32	23	25	12	78	19	123	154	26	22	16	0.6
8-175-015	BB	1.5	32	25	25	12	81	23	131	165	24	19	17	0.7
8-175-02	CC	2.0	36	30	26	13	90	27	145	184	24	20	22	0.9
8-175-03	DD	3.0	41	38	29	16	102	29	172	217	28	25	24	1.5
8-175-05	EE	5.0	46	48	38	21	122	38	218	277	35	31	31	3.2
8-175-07	FF	7.0	61	56	49	23	160	48	261	332	43	39	35	5.7
8-175-11	GG	11.0	74	86	62	25	196	56	327	410	61	57	47	9.5
8-175-15	HH	15.0	97	98	65	33	221	64	372	471	72	62	56	16.5
8-175-22	JJ	22.0	123	116	71	51	277	76	469	599	86	81	68	33.4
8-175-30	KK	30.0	123	116	87	51	353	93	503	651	89	83	76	45.9

★ Design factor 5:1 proof tested and certified.

⚠ WARNING INFORMATION: This hook is a positioning device and is not intended to rotate under load. For swivel hooks designed to rotate under load, see 8-175N.

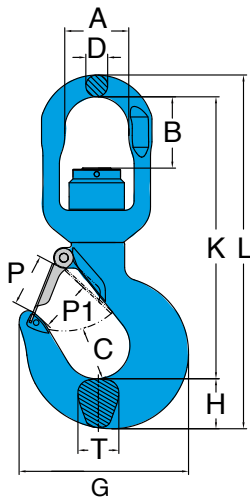

- Quenched and Tempered Alloy Steel.
- Proof Load tested at 2 times of 5:1 WLL with certification for each batch manufactured.
- Fatigue rated to 20,000 cycles at 1.5 times of 5:1 WLL.
- Magnaflux crack detection is performed 100% on each batch.
- YOKE Swivel Hoist Hooks are Predrilled to accept a YOKE latch kits.

Alloy Swivel Bearing Hoist Hook

with Ball Bearing, which performs full swivel under load.

Item No.	Hook Feature Code	Working Load Limit	Dimensions (mm)										N.W. kg	
			mm	A	B	C	D	G	H	K	L	P		P1
8-175N-01	AA	1.0	32	23	25	12	78	19	123	154	26	22	16	0.6
8-175N-015	BB	1.5	32	23	25	12	81	23	131	165	24	19	17	0.7
8-175N-02	CC	2.0	36	29	26	13	90	27	145	184	24	20	22	0.9
8-175N-03	DD	3.0	41	35	29	16	102	29	172	217	28	25	24	1.6
8-175N-05	EE	5.0	46	44	38	21	122	38	218	277	35	31	31	3.2
8-175N-07	FF	7.0	61	50	49	23	160	48	261	332	43	39	35	5.7
8-175N-11	GG	11.0	74	82	62	25	196	56	327	410	61	57	47	9.5
8-175N-15	HH	15.0	97	96	65	33	221	64	372	471	72	62	56	16.0
8-175N-22	JJ	22.0	123	116	71	51	277	76	469	599	86	81	68	33.5
8-175N-30	KK	30.0	123	116	87	51	353	93	503	651	89	83	76	45.0

★ Design factor 5:1 proof tested and certified.

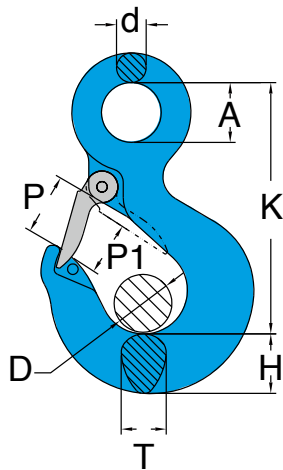

- Quenched and Tempered Alloy Steel.
- At least 25% greater WLL than traditional G80 products.
- Manufactured in accordance with EN 1677- 2 and ASME B30.26.
- Proof Load tested at 2.5 times the WLL with certification for each batch manufactured.
- Design Factor 4:1.
- Fatigue rated to 20,000 cycles at 1.5 times the WLL.
- Tempering temperature minimum 400°C
- Magnaflux crack detection is performed 100% on each batch.

G-100 Eye Hook

Item No.	Hook Feature Code	For Grade 100 Chain	WLL	Dimensions (mm)								N.W.
				mm	tonnes*	A	D	d	H	K	P	
X-173-05	AA	5.0	1.0	23	22	10	22	83	26	22	16	0.3
X-173-06	BB	6.0	1.4	23	19	11	22	95	23	19	17	0.4
X-173-07	CC	7, 8	2.5	29	20	13	27	106	24	20	22	0.7
X-173-10	DD	10.0	4.0	32	25	15	29	122	28	25	24	0.9
X-173-13	EE	13.0	6.7	41	31	18	37	149	36	31	31	2.0
X-173-16	FF	16.0	10.0	51	38	24	48	192	42	39	37	4.0
X-173-20	GG	20.0	16.0	63	57	28	56	233	61	57	47	7.0
X-173-22	HH	22.0	19.0	73	62	32	64	260	68	62	52	9.4
X-173-26	JJ	26.0	26.5	91	81	40	74	318	92	81	68	18.7
X-173-32	KK	32.0	40.0	91	83	45	92	347	89	83	76	31.3

★ Design factor 4:1 proof tested and certified.

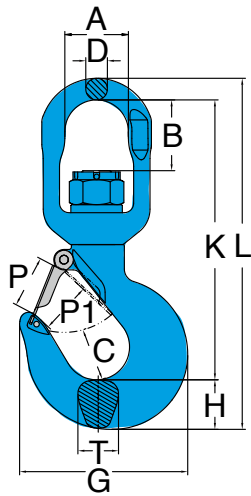

- Quenched and Tempered Alloy Steel.
- At least 25% greater WLL than traditional G80 products.
- Manufactured in accordance with EN 1677- 2 and ASME B30.26.
- Proof Load tested at 2.5 times the WLL with certification for each batch manufactured.
- Design Factor 4:1.
- Fatigue rated to 20,000 cycles at 1.5 times the WLL.
- Tempering temperature minimum 400°C
- Magnaflux crack detection is performed 100% on each batch.

G-100 Swivel Hook

Item No.	Hook Feature Code	For Grade 100 Chain	WLL	Dimensions (mm)										N.W.	
				mm	tonnes*	A	B	C	D	G	H	K	L		P
X-175-05	AA	5	1.0	32	23	25	12	73	19	125	156	24	22	17	0.6
X-175-06	BB	6	1.4	32	25	25	12	81	23	131	165	24	19	22	0.7
X-175-07	CC	7, 8	2.5	36	30	26	13	90	27	145	184	24	20	22	1.0
X-175-10	DD	10	4.0	41	38	29	16	102	29	172	217	28	25	24	1.5
X-175-13	EE	13	6.7	46	48	38	21	122	38	218	277	35	31	31	3.2
X-175-16	FF	16	10.0	61	56	49	23	160	48	261	332	43	39	35	5.6
X-175-20	GG	18-20	16.0	74	86	62	25	196	56	327	410	61	57	47	9.6
X-175-22	HH	22	19.0	97	98	65	33	221	64	372	471	72	62	56	15.9
X-175-26	JJ	26	26.5	123	116	71	51	277	76	469	599	86	81	68	33.4
X-175-32	KK	32	40.0	123	116	87	51	353	93	503	651	89	83	76	45.6

★ Design factor 4:1 proof tested and certified.

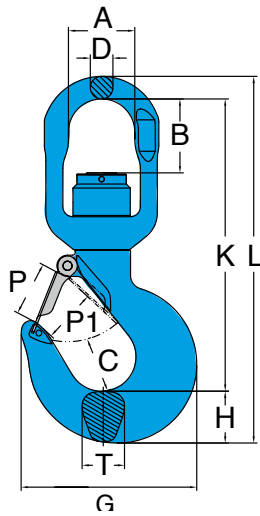

- Quenched and Tempered Alloy Steel.
- At least 25% greater WLL than traditional G80 products.
- Manufactured in accordance with EN 1677- 2 and ASME B30.26.
- Proof Load tested at 2.5 times the WLL with certification for each batch manufactured.
- Design Factor 4:1.
- Fatigue rated to 20,000 cycles at 1.5 times the WLL.
- Tempering temperature minimum 400°C
- Magnaflux crack detection is performed 100% on each batch.
- Built with ball bearing and enables full swivel feature under load.

G-100 Swivel Bearing Hook

Item No.	Hook Feature Code	For Grade 100 Chain	WLL	Dimensions (mm)											N.W.
				mm	tonnes*	A	B	C	D	G	H	K	L	P	
X-175N-05	AA	5	1.0	32	23	25	12	73	19	125	156	24	22	17	0.6
X-175N-06	BB	6	1.4	32	23	25	12	81	23	131	165	24	19	17	0.7
X-175N-07	CC	7, 8	2.5	36	29	26	13	90	27	145	184	24	20	22	1.0
X-175N-10	DD	10	4.0	41	35	29	16	102	29	172	217	28	25	24	1.6
X-175N-13	EE	13	6.7	46	44	38	21	122	38	218	277	35	31	31	3.3
X-175N-16	FF	16	10.0	61	50	49	23	160	48	261	332	43	39	35	5.6
X-175N-20	GG	18-20	16.0	74	82	62	25	196	56	327	410	61	57	47	9.5
X-175N-22	HH	22	19.0	97	96	65	33	221	64	372	471	72	62	56	16.0
X-175N-26	JJ	26	26.5	123	116	71	51	277	76	469	599	86	81	68	33.5
X-175N-32	KK	32	40.0	123	116	87	51	353	93	503	651	89	83	76	45.0

★ Design factor 4:1 proof tested and certified.

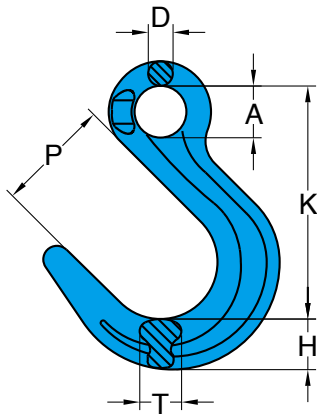

- Quenched and Tempered Alloy Steel.
- At least 25% greater WLL than traditional G80 products.
- Manufactured in accordance with DIN PAS 1061 and ASTM A952/A 952M, EN 1677- 1.
- Certified by DGUV GS-0A-15-05
- Proof Load tested at 2.5 times the WLL with certification for each batch manufactured.
- Design Factor 4:1.
- Fatigue rated to 20,000 cycles at 1.5 times the WLL.
- Tempering temperature minimum 400°C
- Designed for the assembly of chain slings where wide throat openings are necessary.
- Before using the hook, check whether hooks without safety latches are allowed to be used for the particular application.

G-100 Eye Foundry Hook

Item No.	For Grade 100 Chain	WLL tonnes*	Dimensions (mm)						N.W. kg
	mm		A	D	H	K	P	T	
X-047-07	7,8	2.5	24	12	30	123	62	19	0.8
X-047-10	10	4.0	32	15	35	149	74	29	1.6
X-047-13	13	6.7	40	19	39	180	88	32	2.6
X-047-16	16	10.0	50	25	46	215	101	41	4.5
X-047-20	20	16.0	60	26	59	248	113	58	9.3

★ Design factor 4:1 proof tested and certified.

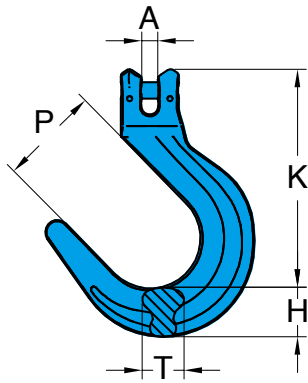

- Quenched and Tempered Alloy Steel.
- At least 25% greater WLL than traditional G80 products.
- Manufactured in accordance with DIN PAS 1061 and ASTM A952/A 952M, EN 1677- 1.
- Certified by DGUV GS-0A-15-05
- Design Factor 4:1.
- Fatigue rated to 20,000 cycles at 1.5 times the WLL.
- Tempering temperature minimum 400°C
- Designed for the assembly of chain slings where wide throat openings are necessary.
- Before using the hook, check whether hooks without safety latches are allowed to be used for the particular application.

G-100 Clevis Foundry Hook

Item No.	For Grade 100 Chain	WLL tonnes*	Dimensions (mm)					N.W. kg
	mm		A	H	K	P	T	
X-046-07	7,8	2.5	10	30	133	62	20	0.95
X-046-10	10	4.0	12	35	162	74	29	1.80
X-046-13	13	6.7	15	39	180	88	32	3.60
X-046-16	16	10.0	18	46	216	101	41	6.40
X-046-20	20	16.0	24	59	279	116	57	11.20

★ Design factor 4:1 proof tested and certified.

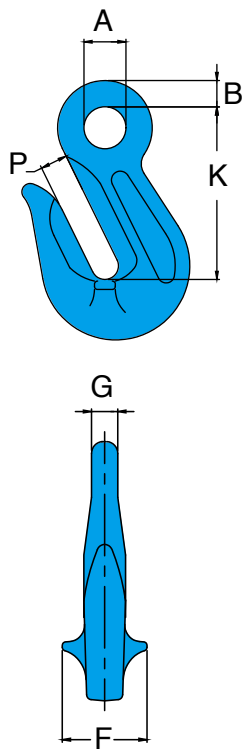

- Quenched and Tempered Alloy Steel.
- At least 25% greater WLL than traditional G80 products.
- Manufactured in accordance with DIN 5692, EN 1677-1 and ASTM A952/A 952M.
- Certified by DGUV GS-MO-15-05.
- Proof Load tested at 2.5 times the WLL with certification for each batch manufactured.
- Design Factor 4:1.
- Fatigue rated to 20,000 cycles at 1.5 times the WLL.
- Tempering temperature minimum 400°C
- Not for use with Omega Link
- Enables full WLL while in use, thanks to supporting wings which prevent chain link deformation.

G-100 Eye Grab Hook

Item No.	For Grade 100 Chain	WLL tonnes*	Dimensions (mm)						N.W. kg
	mm		A	B	F	G	K	P	
X-041-06	6	1.4	13	7	26	8	50	8	0.2
X-041-07	7,8	2.5	16	10	30	9	62	10	0.3
X-041-10	10	4.0	20	13	40	13	82	13	0.6
X-041-13	13	6.7	26	16	52	16	107	17	1.4
X-041-16	16	10.0	30	18	70	20	132	21	2.4
X-041-20	20	16.0	40	22	73	24	148	24	4.0
X-041-22	22	19.0	42	24	86	26	166	26	5.0
X-041-26	26	26.5	50	30	110	32	207	33	10.0
X-041-32	32	40.0	62	37	130	42	266	42	24.0

★ Design factor 4:1 proof tested and certified.

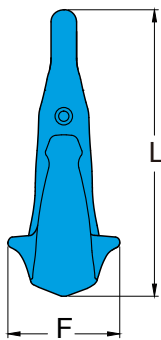
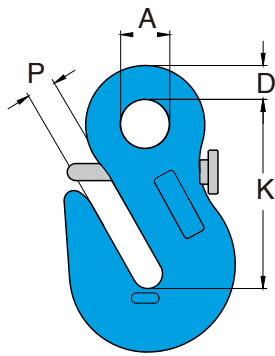

- Quenched and Tempered Alloy Steel.
- At least 25% greater WLL than traditional G80 products.
- Manufactured in accordance with DIN 5692, EN 1677-1 and ASTM A952/A 952M.
- Certified by DGUV GS-0A-15-05.
- Proof Load tested at 2.5 times the WLL with certification for each batch manufactured.
- Design Factor 4:1.
- Fatigue rated to 20,000 cycles at 1.5 times the WLL.
- Tempering temperature minimum 400°C
- Not for use with Omega Link
- Enables full WLL while in use, thanks to supporting wings which prevent chain link deformation.

G-100 Eye Grab Hook

with Safety Pin

Item No.	For Grade 100 Chain	WLL tonnes*	Dimensions (mm)						N.W. kg
	mm		A	D	F	K	L	P	
X-0411-07	7, 8	2.5	16	11	35	65	98	10	0.4
X-0411-10	10	4.0	20	14	46	78	118	12	0.7
X-0411-13	13	6.7	26	18	47	113	169	18	1.7

★ Design factor 4:1 proof tested and certified.

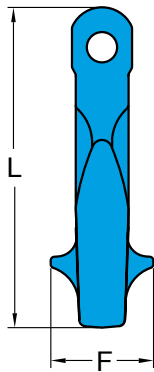
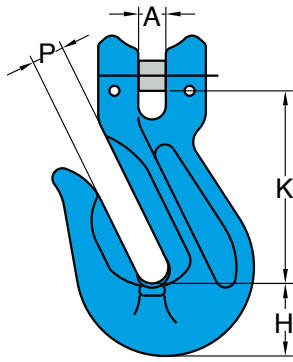

- Quenched and Tempered Alloy Steel.
- At least 25% greater WLL than traditional G80 products.
- Manufactured in accordance with DIN PAS 1061, EN 1677-1 and ASTM A952/A 952M.
- Certified by DGUV GS-0A-15-05.
- Proof Load tested at 2.5 times the WLL with certification for each batch manufactured.
- Design Factor 4:1.
- Fatigue rated to 20,000 cycles at 1.5 times the WLL.
- Tempering temperature minimum 400°C
- Not for use with Omega Link
- Enables full WLL while in use, thanks to supporting wings which prevent chain link deformation.

G-100 Clevis Grab Hook

Item No.	For Grade 100 Chain	WLL tonnes*	Dimensions (mm)					N.W. kg	
	mm		A	F	H	K	L		P
X-042-06	6	1.4	7	25	18	47	79	8	0.2
X-042-07	7,8	2.5	10	30	22	54	93	10	0.4
X-042-10	10	4.0	11	41	29	78	128	13	0.8
X-042-13	13	6.7	15	52	38	99	165	17	1.6
X-042-16	16	10.0	18	57	45	114	195	21	2.7
X-042-20	20	16.0	22	73	52	130	222	24	4.8
X-042-22	22	19.0	24	70	56	139	247	26	6.4

★ Design factor 4:1 proof tested and certified.

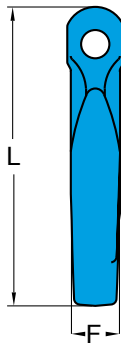
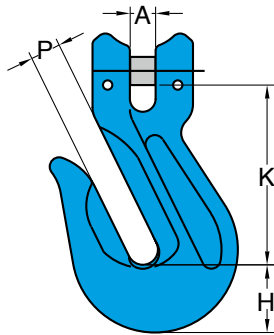

- Quenched and Tempered Alloy Steel.
- At least 25% greater WLL than traditional G80 products.
- Manufactured in accordance with DIN PAS 1061, EN 1677-1 and ASTM A952/A 952M.
- Certified by DGUV GS-0A-15-05.
- Proof Load tested at 2.5 times the WLL with certification for each batch manufactured.
- Design Factor 4:1.
- Fatigue rated to 20,000 cycles at 1.5 times the WLL.
- Tempering temperature minimum 400°C
- Not for use with Omega Link
- Enables full WLL while in use, thanks to supporting wings which prevent chain link deformation.
- For towing application only.

G-100 Clevis Grab Hook

without Cradle

Item No.	For Grade 100 Chain	WLL tonnes*	Dimensions (mm)					N.W. kg	
	mm		A	F	H	K	L		P
X-0421-07	7,8	2.5	10	16	22	54	93	10	0.4
X-0421-10	10	4.0	12	21	29	77	128	13	0.8
X-0421-13	13	6.7	15	26	38	99	165	17	1.6
X-0421-16	16	10.0	18	33	45	114	195	21	2.7

★ Design factor 4:1 proof tested and certified.

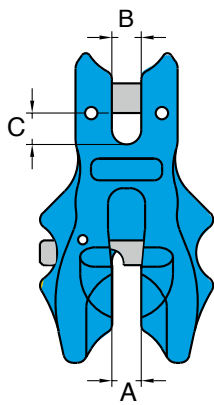

Push to Release →
Spring Locking Pin,
for safety purpose.

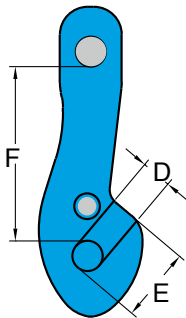

- Quenched and Tempered Alloy Steel.
- At least 25% greater WLL than traditional G80 products.
- Manufactured in accordance with EN 1677- 1 and ASME B30.26.
- Proof Load tested at 2.5 times the WLL with certification for each batch manufactured.
- Design Factor 4:1.
- Fatigue rated to 20,000 cycles at 1.5 times the WLL.
- Tempering temperature minimum 400°C
- The use of Clevis Clutch still allows 100% of the chain sling capacity.
- With the locking system and spring locking pin design to enhance security and prevent the chains from disengaging.

G-100 Clevis Clutch - Locking Type

Item No.	For Grade 100 Chain	WLL tonnes	Dimensions (mm)						N.W. kg
	mm		A	B	C	D	E	F	
X-061-07	7, 8	2.5	10	10	10	10	24	58	0.5
X-061-10	10	4.0	12	12	12	12	34	71	1.0
X-061-13	13	6.7	15	15	16	15	40	92	2.2
X-061-16	16	10.0	21	18	18	19	48	103	3.9

★Design factor 4:1 proof tested and certified.

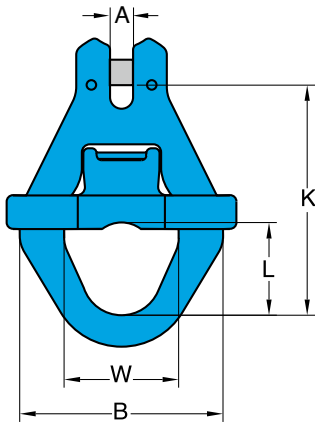

- Quenched and Tempered Alloy Steel.
- At least 25% greater WLL than traditional G80 products.
- Manufactured in accordance with EN 1677- 1 and ASME B30.26.
- Proof Load tested at 2.5 times the WLL with certification for each batch manufactured.
- Design Factor 4:1.
- Fatigue rated to 20,000 cycles at 1.5 times the WLL.
- Tempering temperature minimum 400°C
- The use of Clevis Clutch still allows 100% of the chain sling capacity.
- With the locking system and spring locking pin design to enhance security and prevent the chains from disengaging.

G-100 Clevis Container Hook

Item No.	For Grade 100 Chain	WLL tonnes	Dimensions (mm)					N.W. kg
	mm		A	B	K	L	W	
X-069-10	10	4.0	12	125	138	57	65	1.6
X-069-13	13	6.7	15	125	146	57	65	1.8

★Design factor 4:1 proof tested and certified.



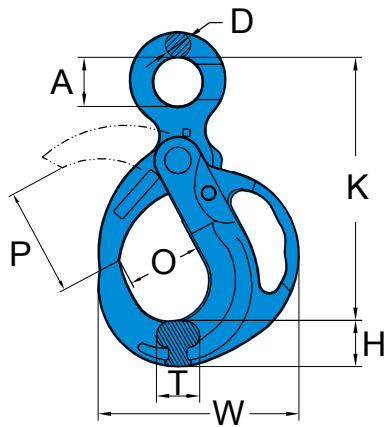

- Quenched and Tempered Alloy Steel.
- Manufactured in accordance with EN 1677- 3.
- Manufactured in accordance with ASTM A952/ A952M, DIN PAS 1061.
- Proof Load tested at 2.5 times the WLL with certification for each batch manufactured.
- Design Factor 4:1.
- Fatigue rated to 20,000 cycles at 1.5 times the WLL.
- Tempering temperature minimum 400°C
- Magnaflux crack detection is performed 100% on each batch.



Designed to protect your fingers

G-100 Eye Grip Safe Locking Hook

Item No.	For Grade 100 Chain	WLL tonnes*	Dimensions (mm)								N.W. kg
	mm		A	D	H	K	O	P	T	W	
X-950-10	10	4.0	33	13	31	176	49	71	27	137	1.9
X-950-13	13	6.7	40	16	39	226	64	80	34	174	4.0
X-950-16	16	10.0	50	21	47	277	78	114	39	212	6.3
X-950-20	20	16.0	62	23	55	329	92	127	54	251	12.3
X-950-22	22	19.0	70	24	59	350	98	151	56	258	14.0

★ Design factor 4:1 proof tested and certified

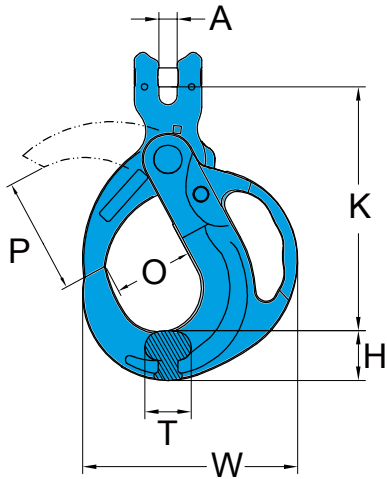

- Quenched and Tempered Alloy Steel.
- Manufactured in accordance with EN 1677- 3.
- Manufactured in accordance with ASTM A952/ A952M, DIN PAS 1061.
- Proof Load tested at 2.5 times the WLL with certification for each batch manufactured.
- Fatigue rated to 20,000 cycles at 1.5 times the WLL.
- Tempering temperature minimum 400°C
- Magnaflux crack detection is performed 100% on each batch.

G-100 Clevis Grip Safe Locking Hook

Item No.	For Grade 100 Chain	WLL tonnes*	Dimensions (mm)							N.W. kg
	mm		A	H	K	O	P	T	W	
X-951-10	10	4.0	12.1	31	153	49	71	27	137	1.9
X-951-13	13	6.7	15.5	39	203	64	80	34	174	4.1
X-951-16	16	10.0	19.1	47	244	78	114	39	212	7.1
X-951-20	20	16.0	24	55	312	92	127	54	251	12.7
X-951-22	22	19.0	24.2	59	304	98	151	56	258	14.1

★ Design factor 4:1 proof tested and certified

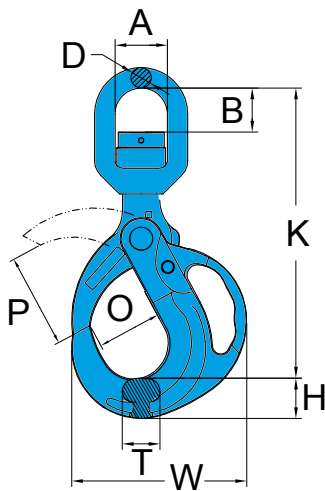

- Quenched and Tempered Alloy Steel.
- Manufactured in accordance with EN 1677- 3.
- Manufactured in accordance with ASTM A952/ A952M, DIN PAS 1061.
- Proof Load tested at 2.5 times the WLL with certification for each batch manufactured.
- Design Factor 4:1.
- Fatigue rated to 20,000 cycles at 1.5 times the WLL.
- Tempering temperature minimum 400°C
- Magnaflux crack detection is performed 100% on each batch.
- Built with ball bearing and enables full swivel feature under load.

G-100 Swivel Grip Safe Locking Hook

Item No.	For Grade 100 Chain	WLL tonnes*	Dimensions (mm)									N.W. kg
	mm		A	B	D	H	K	O	P	T	W	
X-952N-10	10	4.0	41	35	16	31	226	49	71	27	137	2.4
X-952N-13	13	6.7	46	44	21	39	283	64	80	34	174	5.2
X-952N-16	16	10.0	61	50	23	47	347	78	114	39	212	8.4
X-952N-20	20	16.0	74	82	25	55	433	92	127	54	251	14.5
X-952N-22	22	19.0	97	96	33	59	476	98	151	56	258	20.4

★ Design factor 4:1 proof tested and certified

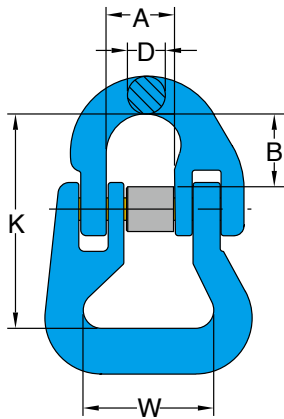

- Quenched and Tempered Alloy Steel.
- At least 25% greater WLL than traditional G80 products.
- Manufactured in accordance with EN 1677- 1, PAS1061 and ASME B30.26.
- Certified by DGUV GS-0A-15-05.
- Proof Load tested at 2.5 times the WLL with certification for each batch manufactured.
- Design Factor 4:1.
- Fatigue rated to 20,000 cycles at 1.5 times the WLL.
- Tempering temperature minimum 400°C
- Magnaflux crack detection is performed 100% on each batch.

G-100 Web Sling Connector

Item No.	WLL tonnes*	Dimensions (mm)					N.W. kg
		A	B	D	K	W	
X-016-06	1.4	15	17	7	56	39	0.2
X-016-07	2.5	18	23	9	63	39	0.3
X-016-10	4.0	25	27	11	77	46	0.6
X-016-13	6.7	30	37	16	97	53	1.1
X-016-16	10.0	36	39	19	114	66	2.0
X-016-20	16.0	42	46	23	132	79	3.2
X-016-22	19.0	49	59	24	188	124	7.7

★ Design factor 4:1 proof tested and certified.

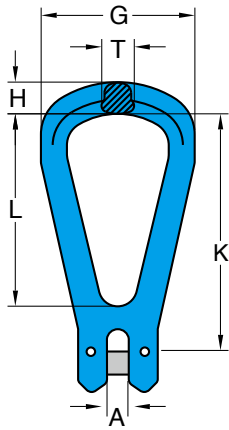

- Quenched and Tempered Alloy Steel.
- At least 25% greater WLL than traditional G80 products.
- Manufactured in accordance with EN 1677- 1 and ASME B30.26.
- Proof Load tested at 2.5 times the WLL with certification for each batch manufactured.
- Design Factor 4:1.
- Fatigue rated to 20,000 cycles at 1.5 times the WLL.
- Tempering temperature minimum 400°C
- Magnaflux crack detection is performed 100% on each batch.

G-100 Single leg Clevis Master Link

Item No.	For Grade 100 Chain	WLL tonnes*	Dimensions (mm)						N.W. kg
	mm		A	G	H	K	L	T	
X-059-07	7,8	2.5	10	65	15	103	83	19	0.4
X-059-10	10	4.0	11	96	19	133	108	19	0.8
X-059-13	13	6.7	15	108	22	168	136	25	1.5
X-059-16	16	10.0	18	124	26	203	165	27	2.4

★ Design factor 4:1 proof tested and certified

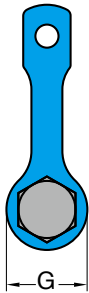
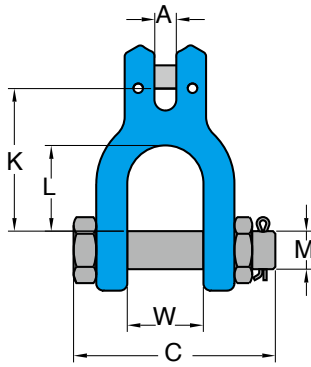

- Quenched and Tempered Alloy Steel.
- At least 25% greater WLL than traditional G80 products.
- Manufactured in accordance with EN 1677- 1 and ASME B30.26.
- Proof Load tested at 2.5 times the WLL with certification for each batch manufactured.
- Design Factor 4:1.
- Fatigue rated to 20,000 cycles at 1.5 times the WLL.
- Tempering temperature minimum 400°C
- Magnaflux crack detection is performed 100% on each batch.

G-100 Clevis Shackle

Item No.	For Grade 100 Chain	WLL tonnes*	Dimensions (mm)							N.W. kg
	mm		A	C	G	K	L	M	W	
X-066-07	7,8	2.5	10	81	34	60	36	16	32	0.4
X-066-10	10	4.0	12	94	40	78	48	20	34	0.8
X-066-13	13	6.7	15	121	44	98	64	22	50	1.4
X-066-16	16	10.0	18	140	55	112	67	28	60	2.5

★ Design factor 4:1 proof tested and certified

G-100 Coupling Pin & Sleeve Set.

for X-015



Item No.	Size		Working Load Limit tonnes*
	inch	mm	
X-P015-06	7/32	6	1.4
X-P015-07	1/4 - 5/16	7	2.5
X-P015-10	3/8	10	4.0
X-P015-13	1/2	13	6.7
X-P015-16	5/8	16	10.0
X-P015-20	3/4	18,20	16.0
X-P015-22	7/8	22	19.0
X-P015-26	1	26	26.5
X-P015-32	1 1/4	32	40.0

Latch Kits.

for 8-044, 8-043, X-044, X-043



Item No.	Size	
	inch	mm
8-P044-06	7/32	6
8-P044-07	1/4 - 5/16	7
8-P044-10	3/8	10
8-P044-13	1/2	13
8-P044-16	5/8	16.0
8-P044-20	3/4	18,20
8-P044-22	7/8	22
8-P044-26	1	26
8-P044-32	1 1/4	32

G-100 Load Pin Kits

for X-026 , X-042 , X-043 , X-046



Item No.	Size		Working Load Limit tonnes*
	inch	mm	
X-P026-06	7/32	6	1.4
X-P026-07	1/4 - 5/16	7	1.5
X-P026-10	3/8	10	4.0
X-P026-13	1/2	13	6.7
X-P026-16	5/8	16	10.0
X-P026-20	3/4	18,20	16.0
X-P026-22	7/8	22	19.0

Trigger Kits For Grip Self Locking Hooks

For X-950, X-951, X-952N



Item No.	Size		Working Load Limit tonnes*
	inch	mm	
X-P950-10	3/8	10	4.0
X-P950-13	1/2	13	6.7
X-P950-16	5/8	16	10.0
X-P950-20	3/4	20,22	16.0

Trigger Kits for G80 and G100 Self Locking Hooks



Item No.	Size	
	inch	mm
8-P025-06	7/32	6
8-P025-07	1/4-5/16	7
8-P025-10	3/8	10
8-P025-13	1/2	13
8-P025-16	5/8	16
8-P025-20	3/4	18,20
8-P025-22	7/8	22
8-P025-26	1	26
8-P025-28	1-1/8	28

**For G100 size 20mm: X-P025-20

Index by Part No.

Product No.	Repair Kits No.
X-025-06	8-P025-06
X-025-07	8-P025-07
X-025-10	8-P025-10
X-025-13	8-P025-13
X-025-16	8-P025-16
X-025-20	X-P025-20
X-025-22	8-P025-22
X-025-26	8-P025T-26
X-025-28	8-P025-28
8-025-06	8-P025-06
8-025-07	8-P025-07
8-025-10	8-P025-10
8-025-13	8-P025-13
8-025-16	8-P025-16
8-025-20	8-P025T-20
8-025-22	8-P025-22
8-025-26	8-P025T-26
8-025-28	8-P025T-28

New Trigger Kits for Self Locking Hooks size 20mm, 26mm, and 28mm after design change



G80 size 20mm		
Item No.	Size	
	inch	mm
8-P025T-20	3/4	18,20
G80 and G100 size 26mm		
Item No.	Size	
	inch	mm
8-P025T-26	1	26
G80 size 28mm		
Item No.	Size	
	inch	mm
8-P025T-28	1-1/8	28





DANGER: Overhead lifting presents a very real danger of severe injury or loss of life if lifting equipment is not used properly. Please read and understand all of these instructions prior to using any lifting sling or sling assembly. Sling should only be used by qualified persons who are responsible for the sling selection, inspection and use.

Grade 80 Chain Sling Components

WORKING LOAD LIMITS IN TONNES acc. to EN1677

90°						Choke endless sling
For Chain Size mm	tonnef	80 - 45° α 0 - 90°	45° - 60° 90° - 120°	80 - 45° α 0 - 90°	45° - 60° 90° - 120°	
6	1.12	1.6	1.12	2.36	1.7	1.8
7	1.5	2.12	1.5	3.15	2.24	2.5
8	2.0	2.8	2.0	4.25	3.0	3.15
10	3.15	4.25	3.15	6.7	4.75	5.0
13	5.3	7.5	5.3	11.2	8.0	8.5
16	8.0	11.2	8.0	17.0	11.5	12.5
19	11.2	16.0	11.2	23.6	17.0	18.0
20	12.5	17.0	12.5	26.5	19.0	20.0
22	15.0	21.2	15.0	31.5	22.4	23.6
26	21.2	30.0	21.2	45.0	31.5	33.5
32	31.5	45.0	31.5	67.0	47.5	50.0

**Safety factor 4:1 above limits are valid for standard use and equally loaded slings. Properly use and maintenance of your YOKE chain slings will give long life and enable you to carry out your lifting operations efficiently and safely.

Warning: Never exceed a vertical sling angle of 60°

SAFE USE

- Never load in excess of the rated capacity for the application.
- Keep a record of all slings in use.
- User should remove all twists from a chain leg before lifting and, should never knot a chain.
- Always use YOKE shortening hook or clutch when chain slings should be shortened.
- Always inspect to insure that chain is free from damage or wear before use.
- Always inspect all sling components prior to each use.
- Ensure that chain is protected from any sharp corners on the load.
- Ensure that the master link articulates freely on the hook of the crane or other lifting appliance.
- Never tip load hooks. The load should always be supported correctly in the bowl of the hook.
- Always use the correct size sling for the load, allowing for the included angle and the possibility of unequal loading.
- Personnel must keep all body parts from between the sling and the load, and from between the sling and the crane/hoist hook. Persons shall never ride the chain sling/rope sling or web sling or the load during lifting or while suspended. Persons must stand clear of all loads while lifting or while suspended. During lifting, with or without the load, personnel must be alert for possible snagging of the load or the chain sling.

MAINTENANCE

- A thorough examination should be carried out by a competent person at intervals at least every year or more frequently according to statutory regulations, type of use and past records.
- Chains with bent links or with cracks or gouges in the link should be replaced, as should deformed components such as bent master links, deformed hooks and any fittings showing signs of damage.
- Chain and components wear should never exceed 10% of the original dimensions.
- Once a chain sling has been overloaded it must be taken out of service.
- Store chain slings on a properly designed rack. They should not be left lying on the floor where they may suffer mechanical or corrosion damage or may be lost.

LIMITATION ON USE

- YOKE alloy chain or chain slings should not be used in acid or caustic solutions nor in heavily acidic or caustic laden atmospheres. The high tensile strength of the heat treated alloy material in alloy steel chains and components is susceptible to hydrogen embrittlement when exposed to acids.
- YOKE slings must not be heat-treated, galvanized, plated, coated or subject to any process involving heating or pickling. Each of these processes can have dangerous effects and will invalidate the manufacturer certificate.
- YOKE slings may be used at temperatures between -40°C to 200°C with no reduction in the working load limit. The use of YOKE chain slings within the permissible temperature range in the table below does not require any permanent reduction in working load limit when the chain sling is returned to normal temperatures. A sling accidentally exposed to temperatures in excess of the maximum permissible should be withdrawn from service immediately and returned to the distributor for thorough examination.
- When using YOKE slings in exceptionally hazardous conditions, the degree of hazard should be assessed by a competent person and the Working Load Limit adjusted accordingly. Examples are lifting of potentially dangerous loads such as molten metals, corrosive materials or fissile material and including certain offshore activities.

Sling temperature (F)	Sling temperature (C)	Reduction in Working Load Limit
-40°F to 400°F	-40°C to 200°C	None
400°F to 550°F	200°C to 300°C	10%
550°F to 750°F	300°C to 400°C	25%
Above 750°F	Above 400°C	Do not use.

Oblong Master Link.

Connected to Chain with "YA" connecting link.

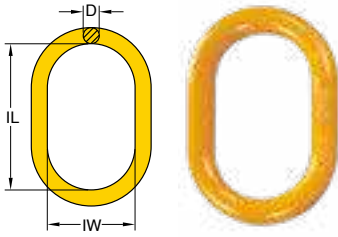

Extra width inside allows better works on large crane hooks.

Item No.	WLL β 0-45° tonnes*	For Grade 80 Chain(mm)		Dimensions (mm)			N.W. kg
		1 Leg	2 Leg	D	IL	IW	
8-003-06	※ 1.25	6	--	11	100	60	0.2
8-003-0806	※ 2.5	7, 8	6	14	120	70	0.4
8-003-1008	※ 4.0	10	7, 8	17	140	80	0.7
8-003-13	※ 5.4	13	--	19	150	90	1.1
8-003-1310	※ 7.5	13	10	22	160	95	1.5
8-003-16	※ 10.0	16	--	25	190	110	2.2
8-003-1613	※ 10.0	16	13	28	180	105	2.8
8-003-19	※ 12.0	19, 20	--	30	200	120	3.8
8-003-2216	※ 17.0	22	16	34	240	140	5.5
8-003-26	※ 25.0	26	--	38	250	150	7.0
8-003-2619	※ 28.0	26	19, 20	40	250	150	8.0
8-003-3222	※ 37.0	32	22	45	300	180	12.7

※ Forged Oblong Master Links.

Design factor 4:1 proof tested and certified Tested acc. to EN 1677

Oblong Master Link with Flat.

Connected to Chain with "YO" Omega Link.

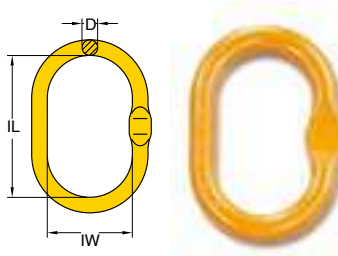

Item No.	WLL β 0-45° tonnes*	For Grade 80 Chain(mm)		Dimensions (mm)			N.W. kg
		1 Leg	2 Leg	D	IL	IW	
8-003F-06	※ 1.25	6	--	11	100	60	0.2
8-003F-0806	※ 2.50	7, 8	6	14	120	70	0.4
8-003F-1008	※ 4.00	10	7, 8	17	140	80	0.7
8-003F-1310	※ 7.50	13	10	22	160	95	1.5
8-003F-1613	※ 10.00	16	13	28	184	105	2.8
8-003F-2216	※ 17.00	20	16	34	245	140	5.3
8-003F-2619	※ 25.00	--	19, 20	40	250	150	8.0

※ Forged Oblong Master Links.

★ Design factor 4:1 Proof tested and certified

WLL=Working Load Limit Tested acc. to EN 1677

Clevis Master Link.

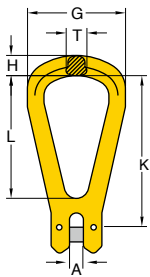

Item No.	Working Load Limit tonnes*	For Grade 80 Chain mm	Dimensions (mm)						N.W. kg
			A	G	H	K	L	T	
8-059-07	2.0	7, 8	10	65	15	103	83	19	0.4
8-059-10	3.15	10	11	96	19	133	108	19	0.8
8-059-13	5.3	13	15	108	22	168	136	25	1.5
8-059-16	8.0	16	18	124	26	203	165	27	2.4

★ Design factor 4:1 proof tested and certified
Tested acc. to EN 1677

Connecting Link

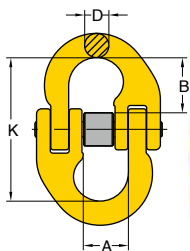

Item No.	Working Load Limit tonnes*	For Grade 80 Chain mm	Dimensions (mm)				N.W. kg
			A	B	D	K	
8-015-06	1.12	6	15	17	7	45	0.1
8-015-07	2.00	7, 8	18	22	9	58	0.2
8-015-10	3.15	10	26	27	11	69	0.3
8-015-13	5.30	13	30	37	15	91	0.7
8-015-16	8.00	16	36	39	19	101	1.1
8-015-20	12.50	18, 20	42	46	22	122	1.9
8-015-22	15.00	22	49	59	24	152	3.0
8-015-26	21.20	26	55	63	30	164	5.0
8-015-32	31.50	32	69	79	36	203	9.0

★ Design factor 4:1 proof tested and certified
Tested acc. to EN 1677

Connecting Link

Dacromet® Surface Finish.**

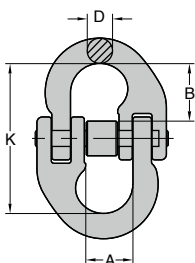

Item No.	Working Load Limit tonnes*	For Grade 80 Chain mm	Dimensions (mm)				N.W. kg
			A	B	D	K	
8-M015-06	1.12	6	15	17	7	45	0.10
8-M015-07	2.00	7, 8	18	24	9	58	0.16
8-M015-10	3.15	10	26	28	11	69	0.30
8-M015-13	5.30	13	30	38	15	91	0.70
8-M015-16	8.00	16	36	41	19	101	1.20
8-M015-20	12.50	18, 20	42	50	22	122	1.90
8-M015-22	15.00	22	49	63	24	152	3.00
8-M015-26	21.20	26	55	66	30	164	4.60
8-M015-32	31.50	32	69	85	36	203	8.50

★ Design factor 4:1 proof tested and certified
Tested acc. to EN 1677

Omega Link.

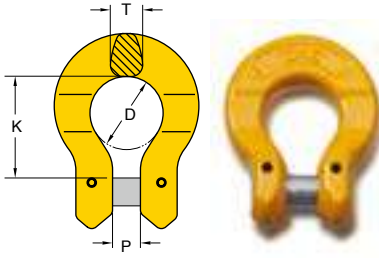

Item No.	Working Load Limit tonnes*	For Grade 80 Chain mm	Dimensions (mm)				N.W. kg
			D	K	P	T	
8-018-06	1.12	6	22	29	7	9	0.1
8-018-07	2.00	7, 8	27	36	9	11	0.2
8-018-10	3.15	10	32	44	12	15	0.4
8-018-13	5.30	13	42	55	16	17	0.8
8-018-16	8.00	16	50	69	18	22	1.6
8-018-20	12.50	18, 20	58	81	22	28	2.1

★ Design factor 4:1 proof tested and certified
Tested acc. to EN 1677



Swivel Self Locking Hook.

with Brass Bushing

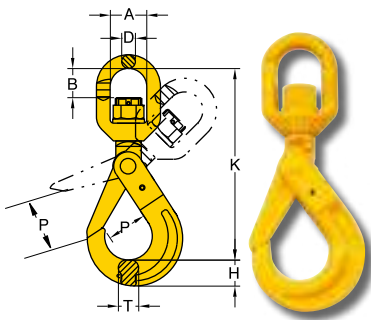

Item No.	Working Load Limit tonnes*	For Grade 80 Chain mm	Dimensions (mm)							N.W. kg
			A	B	D	H	K	P	T	
8-027-06	1.12	6	32	25	12	19	149	28	15	0.7
8-027-07	2.00	7, 8	36	30	14	24	186	34	20	1.2
8-027-10	3.15	10	41	38	16	30	218	44	26	2.0
8-027-13	5.30	13	46	48	22	39	276	51	30	4.1
8-027-16	8.00	16	61	56	24	49	329	61	36	7.2
8-027-20	12.50	18, 20	74	86	26	62	403	91	48	11.5
8-027-22	15.00	22	97	98	33	63	457	80	49	18.6
8-027-26	21.20	26	123	120	26	69	535	99	56	31.9

★ Design factor 4:1 proof tested and certified
Tested acc. to EN 1677

⚠ WARNING INFORMATION: This hook is a positioning device and is not intended to rotate under load. For swivel hooks designed to rotate under load, see 8-027N .

Swivel Self Locking Hook.

with Ball Bearing, which performs full swivel underload

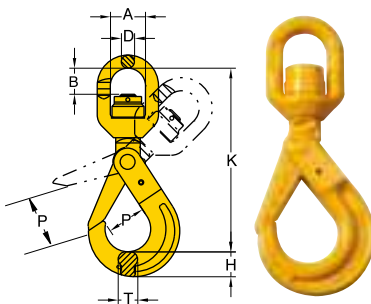

Item No.	Working Load Limit tonnes*	For Grade 80 Chain mm	Dimensions (mm)							N.W. kg
			A	B	D	H	K	P	T	
8-027N-06	1.12	6	32	23	12	19	149	28	15	0.7
8-027N-07	2.00	7, 8	36	29	14	24	186	34	20	1.2
8-027N-10	3.15	10	41	34	16	30	218	44	26	2.0
8-027N-13	5.30	13	46	44	22	39	276	51	30	4.2
8-027N-16	8.00	16	61	51	24	49	329	61	36	7.3
8-027N-20	12.50	18, 20	74	82	26	62	403	91	48	11.7
8-027N-22	15.00	22	97	96	33	63	457	80	49	18.0
8-027N-26	21.20	26	123	116	26	69	535	99	56	32.0

★ Design factor 4:1 proof tested and certified
Tested acc. to EN 1677

How to use YOKE Self Locking Hook?



Eye Self Locking Hook.

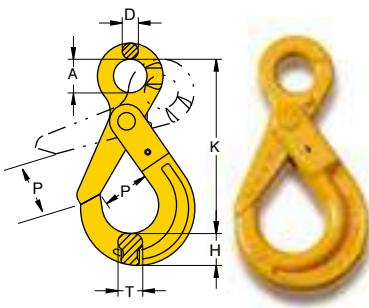

Item No.	Working Load Limit tonnes*	For Grade 80 Chain mm	Dimensions (mm)						N.W. kg
			A	D	H	K	P	T	
8-025-06	1.12	6	21	10	19	110	28	15	0.5
8-025-07	2.00	7,8	25	11	24	136	34	20	0.8
8-025-10	3.15	10	33	13	30	167	44	26	1.4
8-025-13	5.30	13	40	16	39	207	51	30	3.0
8-025-16	8.00	16	50	21	49	252	61	36	5.8
8-025-20	12.50	18, 20	62	23	62	281	91	48	8.5
8-025-22	15.00	22	70	24	63	319	80	49	12.5
8-025-26	21.20	26	80	25	69	343	99	56	14.0
8-025-28	25.00	28	92	28	81	405	123	63	26.0

★ Design factor 4:1 proof tested and certified
Tested acc. to EN 1677

Clevis Self Locking Hook.

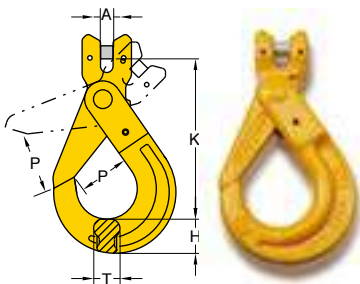

Item No.	Working Load Limit tonnes*	For Grade 80 Chain mm	Dimensions (mm)					N.W. kg
			A	H	K	P	T	
8-026-06	1.12	6	7	19	93	28	15	0.5
8-026-07	2.00	7,8	9	24	119	34	20	0.8
8-026-10	3.15	10	12	30	143	44	26	1.4
8-026-13	5.30	13	15	39	179	51	30	2.9
8-026-16	8.00	16	18	49	212	61	36	5.6
8-026-20	12.50	18, 20	21	62	243	91	48	9.0
8-026-22	15.00	22	24	63	273	80	49	13.0

★ Design factor 4:1 proof tested and certified
Tested acc. to EN 1677

Eye Sling Hook.
with Latch

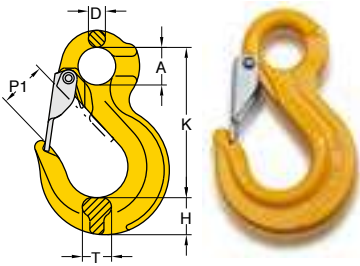

Item No.	Working Load Limit tonnes*	For Grade 80 Chain mm	Dimensions (mm)						N.W. kg
			A	D	H	K	P1	T	
8-044/S-06	1.12	6	20	10	19	80	23	17	0.3
8-044/S-07	2.00	7, 8	25	12	22	98	28	20	0.5
8-044/S-10	3.15	10	32	15	30	121	36	23	1.0
8-044/S-13	5.30	13	40	18	38	152	40	28	1.7
8-044/S-16	8.00	16	50	22	45	185	44	32	3.2
8-044/S-20	12.50	18, 20	62	27	49	225	45	46	5.5
8-044/S-22	15.00	22	51	31	62	244	73	52	9.0
8-044/S-26	21.20	26	64	35	77	285	77	61	13.5
8-044/S-32	31.50	32	89	40	80	352	114	65	20.0

★ Design factor 4:1 proof tested and certified
Tested acc. to EN 1677

Eye Foundry Hook.

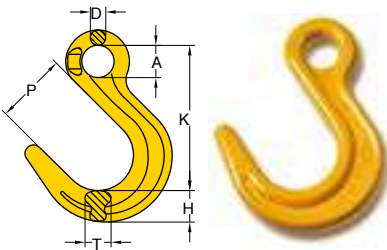

Item No.	Working Load Limit tonnes*	For Grade 80 Chain mm	Dimensions (mm)						N.W. kg
			A	D	H	K	P	T	
8-047-07	2.00	7, 8	24	12	27	122	61	19	0.7
8-047-10	3.15	10	32	15	32	150	74	23	1.3
8-047-13	5.30	13	40	19	39	180	88	32	2.3
8-047-16	8.00	16	50	24	46	215	98	41	4.1
8-047-20	12.50	18,20	60	26	59	248	112	58	9.3

★ Design factor 4:1 proof tested and certified
Tested acc. to EN 1677

Shackle Eye Swivel Hook, with brass bushing.

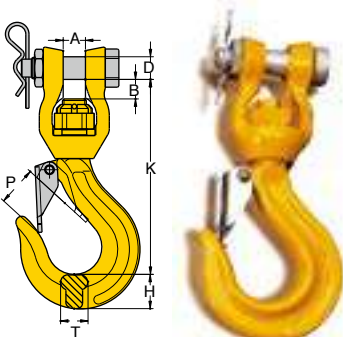

Item No.	Working Load Limit tonnes*	For Grade 80 Chain mm	Dimensions (mm)						N.W. kg	
			A	B	D	H	K	P		T
8-048-16	8.0	16	28	28	28	45	225	54	35	6.0

★ Design factor 4:1 proof tested and certified.
Tested acc. to EN 1677

⚠ **WARNING INFORMATION:** This hook is a positioning device and is not intended to rotate under load.

Clevis Sling Hook. with Latch

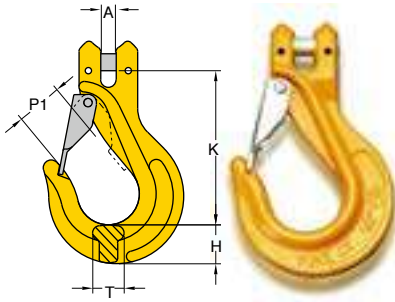

Item No.	Working Load Limit tonnes*	For Grade 80 Chain mm	Dimensions (mm)					N.W. kg
			A	H	K	P1	T	
8-043/S-06	1.12	6	7	18	79	23	15	0.3
8-043/S-07	2.00	7, 8	9	22	98	27	18	0.6
8-043/S-10	3.15	10	12	29	121	34	23	1.2
8-043/S-13	5.30	13	15	37	147	44	30	2.3
8-043/S-16	8.00	16	18	42	166	48	39	3.7
8-043/S-20	12.50	18, 20	21	50	200	56	47	6.5

★ Design factor 4:1 proof tested and certified
Tested acc. to EN 1677

Clevis Shackle.

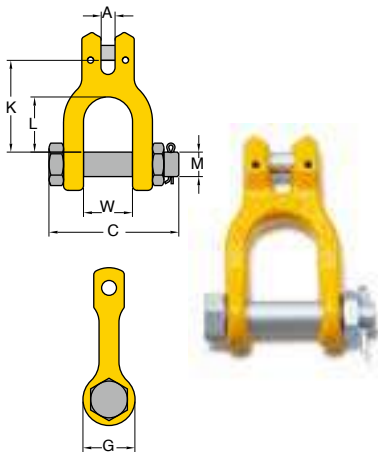

Item No.	Working Load Limit tonnes*	For Grade 80 Chain mm	Dimensions (mm)							N.W. kg
			A	C	G	K	L	M	W	
8-066-07	2.00	7, 8	9	79	34	59	35	16	32	0.4
8-066-10	3.15	10	12	93	40	78	48	20	34	0.8
8-066-13	5.30	13	15	118	44	98	64	22	50	1.4
8-066-16	8.00	16	18	141	55	112	68	28	60	2.4

★ Design factor 4:1 proof tested and certified
Tested acc. to EN 1677

Clevis C Hook.

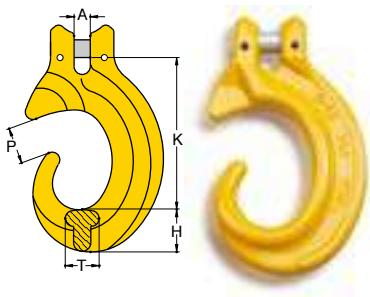

Item No.	Working Load Limit tonnes*	For Grade 80 Chain mm	Dimensions (mm)					N.W. kg
			A	H	K	P	T	
8-097-07	2.00	7, 8	9	22	80	19	18	0.5
8-097-10	3.15	10	12	26	103	26	24	0.9
8-097-13	5.30	13	15	34	135	34	32	2.1
8-097-16	8.00	16	18	45	160	38	37	3.8

★ Design factor 4:1 proof tested and certified
Tested acc. to EN 1677

Eye Swivel Hook.

with Ball Bearing, which performs full swivel under load

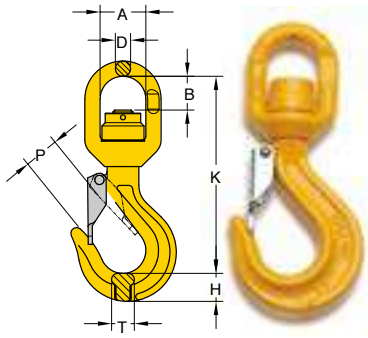

Item No.	Working Load Limit tonnes*	For Grade 80 Chain mm	Dimensions (mm)							N.W. kg
			A	B	D	H	K	P	T	
8-049N-06	1.12	6	32	23	11	19	136	24	16	0.6
8-049N-07	2.00	7, 8	36	27	12	22	155	26	18	0.9
8-049N-10	3.15	10	41	37	16	29	189	36	23	1.6
8-049N-13	5.30	13	46	40	21	35	233	42	28	3.4
8-049N-16	8.00	16	61	50	22	44	280	50	35	5.1
8-049N-20	12.50	18, 20	74	82	25	65	356	56	49	9.5

★ Design factor 4:1 proof tested and certified
Tested acc. to EN 1677

Clevis Traveling Clutch.

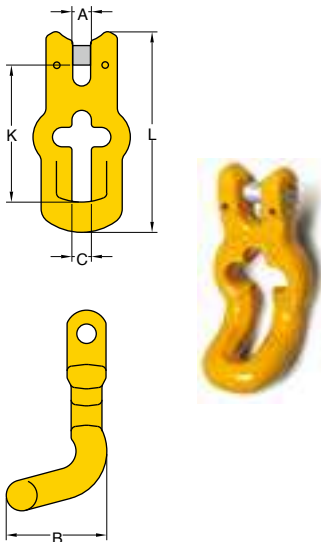

Item No.	Working Load Limit tonnes*	For Grade 80 Chain mm	Dimensions (mm)					N.W. kg
			A	B	C	K	L	
8-064-06	1.12	5, 6	7	31	8	64	86	0.2
8-064-07	2.00	7, 8	9	44	10	73	104	0.4
8-064-10	3.15	10	11	61	13	82	121	0.7

★ Design factor 4:1 proof tested and certified.
Tested acc. to EN 1677

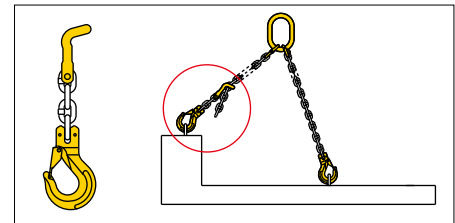

Shank Self Locking Hook.

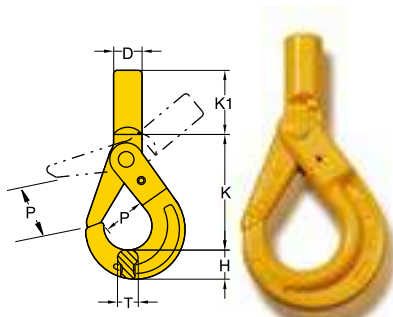

Item No.	Working Load Limit tonnes*	Shank Dimensions		Dimensions (mm)					N.W. kg
		D	d min**	H	K	K1	P	T	
8-024-06	1.12	21	11	19	90	37	28	15	0.5
8-024-07	2.00	25	13	24	115	43	34	20	0.9
8-024-10	3.15	29	16	33	135	48	44	26	1.5
8-024-13	5.30	34	20	39	171	64	51	30	3.0
8-024-16	8.00	37	25	49	204	75	61	36	5.5
8-024-20	12.50	43	38	62	219	90	91	48	9.0
8-024-22	15.00	51	45	63	251	115	80	49	12.0
8-024-26	21.20	65	50	69	271	151	99	56	18.0

** d min. = the smallest shank dimension after machining.

Note: After machining the shank, proof loading must be carried out.

★ Design factor 4:1

Eye Grab Hook.

Not for use with Omega Link Item. 8-018
No reduction of working load limit, thanks to supporting wings which prevent chain link deformation.

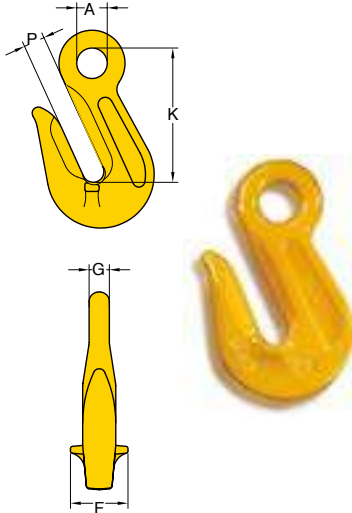

Item No.	Working Load Limit tonnes*	For Grade 80 Chain mm	Dimensions (mm)					N.W. kg
			A	F	G	K	P	
8-041-06	1.12	6	13	26	8	51	8	0.2
8-041-07	2.00	7, 8	15	30	9	62	10	0.3
8-041-10	3.15	10	20	40	13	82	13	0.6
8-041-13	5.30	13	26	52	16	107	16	1.4
8-041-16	8.00	16	30	70	20	132	22	2.3
8-041-20	12.50	18, 20	38	73	24	147	24	3.9
8-041-22	15.00	22	42	86	26	166	26	4.7
8-041-26	21.20	26	50	110	32	207	30	9.9
8-041-32	31.50	32	61	127	41	269	37	21.4

★ Design factor 4:1 proof tested and certified.
Tested acc. to EN 1677

Clevis Grab Hook.

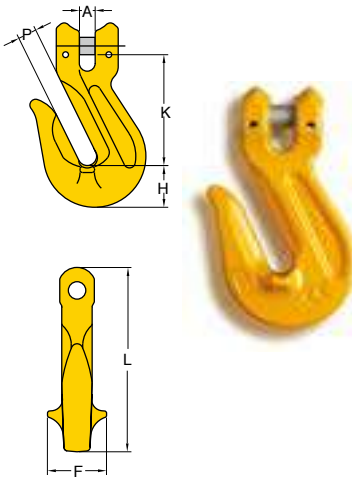

Item No.	Working Load Limit tonnes*	For Grade 80 Chain mm	Dimensions (mm)						N.W. kg
			A	F	H	K	L	P	
8-042-06	1.12	6	7	25	17	47	79	8	0.2
8-042-07	2.00	7, 8	9	30	21	54	93	10	0.3
8-042-10	3.15	10	12	41	29	77	128	13	0.8
8-042-13	5.30	13	15	52	37	99	165	16	1.6
8-042-16	8.00	16	18	57	45	114	195	20	2.8
8-042-20	12.50	18, 20	21	73	52	130	222	23	4.8

★ Design factor 4:1 proof tested and certified.
Tested acc. to EN 1677

Clevis Clutch - Locking Type.

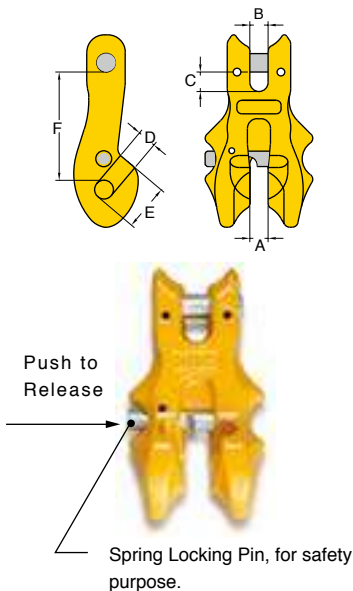

Item No.	Working Load Limit tonnes*	For Grade 80 Chain mm	Dimensions (mm)						N.W. kg
			A	B	C	D	E	F	
8-061-06	1.12	6	7	7	10	7	18	50	0.3
8-061-07	2.00	7, 8	10	10	10	10	24	56	0.5
8-061-10	3.15	10	12	12	12	12	28	66	0.9
8-061-13	5.30	13	15	15	16	16	39	88	2.2
8-061-16	8.00	16	21	18	18	19	48	103	3.7
8-061-20	12.50	18, 20	23	22	23	23	53	129	5.8

★ Design factor 4:1 proof tested and certified.
Tested acc. to EN 1677



Eye Container Hook.

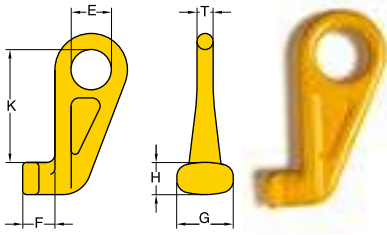

Item No.	Dsc.	Working Load Limit tonnes*	Dimensions (mm)						N.W. kg
			E	F	G	H	K	T	
8-067-STR	Straight	12.5	70	45	75	48	192	25	3.9
8-067-45LT	Left 45°	12.5	70	45	75	48	192	25	3.9
8-067-45RH	Right 45°	12.5	70	45	75	48	192	25	3.9

8-067-45LT

8-067-45RH

8-067-STR



★ Design factor 4:1 proof tested and certified.

**Shortening Clutch
with Half Link**

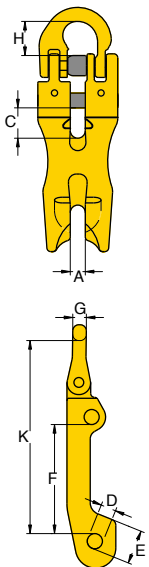

Item No.	Working Load Limit tonnes*	For Grade 80 Chain mm	Dimensions (mm)								N.W. kg
			A	C	D	E	F	H	G	K	
8-078-07	2.00	7, 8	12	20	10	23	70	22	9	128	0.7
8-078-10	3.15	10	13	26	12	29	87	26	11	154	1.3
8-078-13	5.30	13	15	33	16	37	115	36	15	203	2.8
8-078-16	8.00	16	21	39	19	46	143	39	19	248	5.3

★ Design factor 4:1 proof tested and certified.
Tested acc. to EN 1677







Insulate

1000 Volts Resistance

YOKE Insulation Solution



YOKE Insulation Solution

- YOKE Insulated Swivel is designed for winch protection in overhead crane during welding operations.
- Heavy hoisting with a strong but lightweight system.
- Individual swivels & components are proof load tested to a minimum of 2.5 times the working load limit.
- All Swivels are individually tested during manufacturing to assure 1000 Volts insulating property. Test certificate is packaged with each unit shipped.
- YOKE Insulated Swivels are designed with ball bearing which performs to fully swivel under Load.
- Acquired  certificate approved by Deutsche Gesetzliche Unfallversicherung (DGUV) .

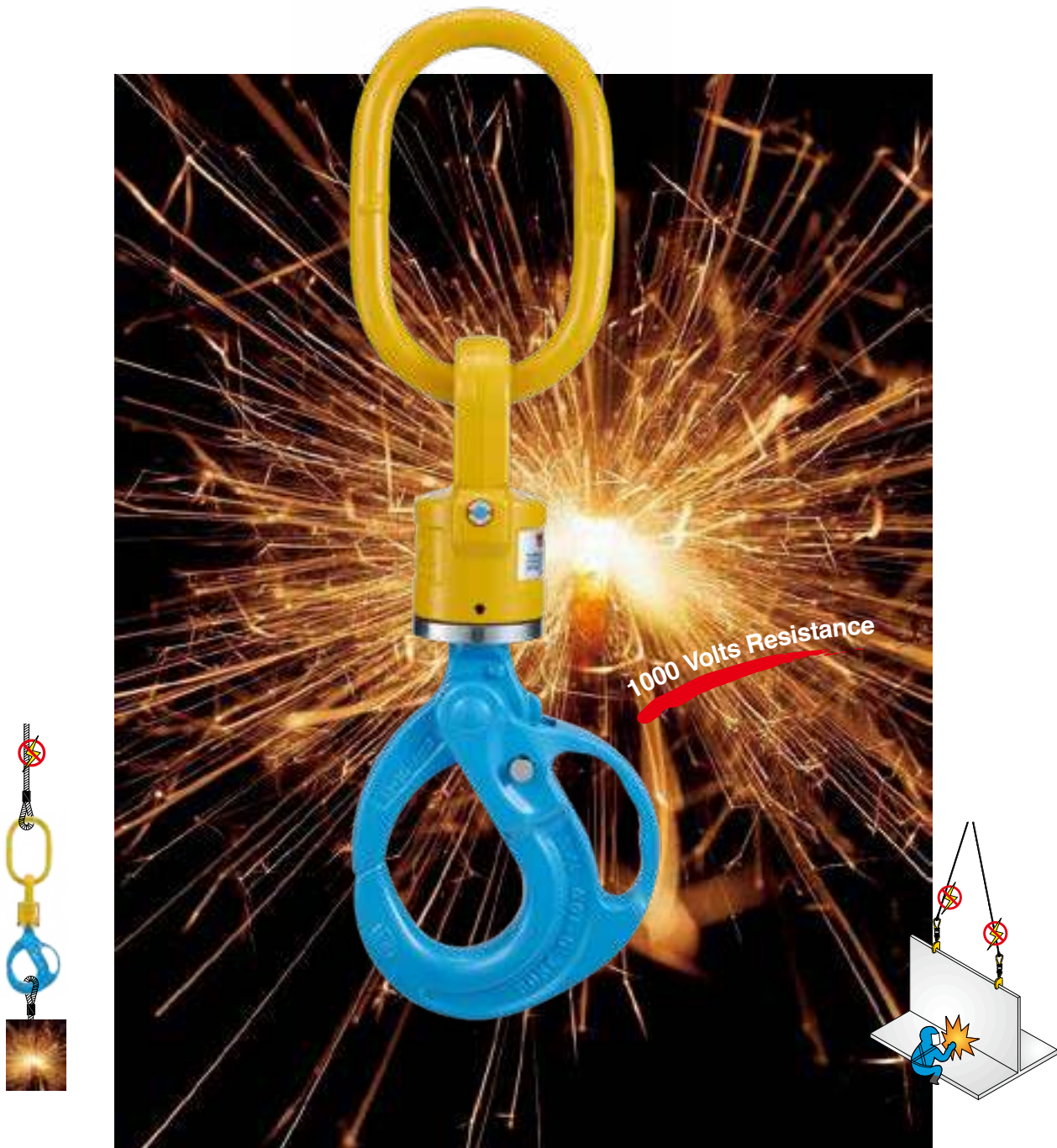

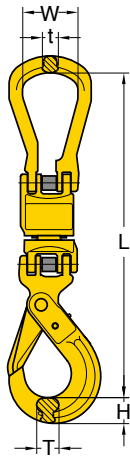

1000 Volts Resistance

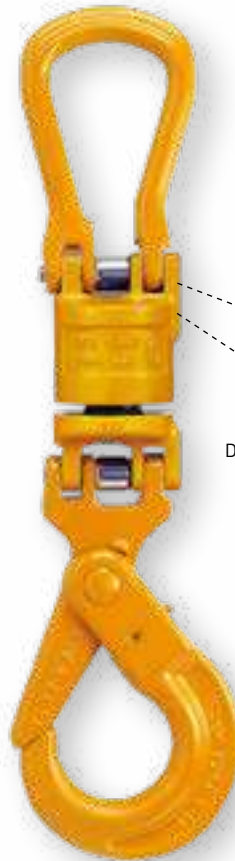

Digital Chip embedded

Digital Chip embedded with Certificate for serial Traceability

- Individually tested to resist 1000 Volts insulated with Test Certificate.
- Design for protection Winch of overhead crane during welding operations on suspended loads.

Insulated Sling Swivel Hook

Item No.	Working Load Limit tonnes*	For Grade 80 Chain mm	Dimensions (mm)					N.W. kg
			H	L	T	W	t	
8-124-07	2.00	7, 8	24	310	20	50	15	1.8
8-124-10	3.15	10	30	374	26	65	19	3.3
8-124-13	5.30	13	39	471	30	72	23	6.7
8-124-16	8.00	16	49	560	36	80	25	12.0
8-124-20	12.50	18, 20	62	624	48	104	31	18.0

★ Design factor 4:1 proof tested and certified
Tested acc. to EN 1677

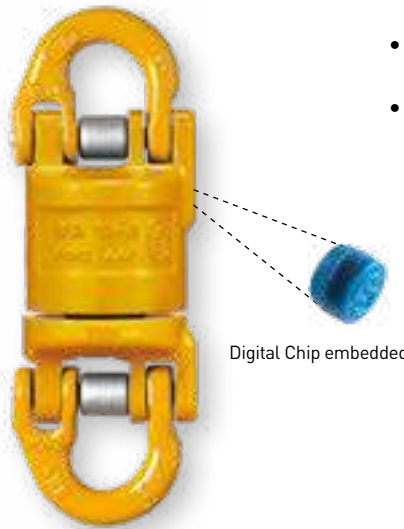
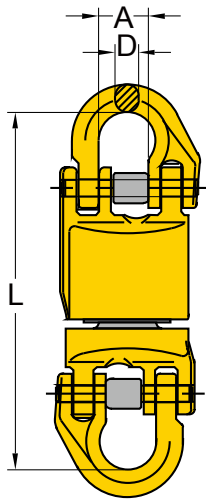

- Individually tested to resist 1000 Volts insulated with Test Certificate.
- Design for protection Winch of overhead crane during welding operations on suspended loads.

Digital Chip embedded

1000 Volts Resistance

Digital Chip embedded with Certificate for serial Traceability

Insulated Swivel Connectors

Item No.	Working Load Limit tonnes*	For Grade 80 Chain mm	Dimensions (mm)			N.W. kg
			A	D	L	
8-123-07	2.00	7, 8	18	9	131	0.7
8-123-10	3.15	10	25	11	162	1.5
8-123-13	5.30	13	30	16	214	3.2
8-123-16	8.00	16	36	19	243	5.4
8-123-20	12.50	18, 20	42	22	285	9.0

★ Design factor 4:1 proof tested and certified
Tested acc. to EN 1677

Insulated Blank Swivels.

with Ball Bearing

Individually tested to resist 1000 Volts insulated with Test Certificate.

Design for protection of overhead crane during welding operations on suspended loads.

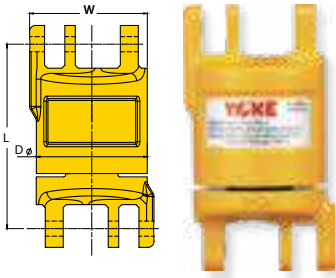

1000 Volts Resistance

Item No.	Working Load Limit tonnes*	For Grade 80 Chain mm	Dimensions (mm)			N.W. kg
			L	D	W	
8-088N-07	2.00	7, 8	75	48	50.0	0.7
8-088N-10	3.15	10	97	58	62.0	1.3
8-088N-13	5.30	13	123	74	78.5	2.7
8-088N-16	8.00	16	143	90	95.0	4.7
8-088N-20	12.50	18, 20	164	105	110.0	7.0

★ Design factor 4:1 proof tested and certified.
Tested acc. to EN 1677

Half Coupling Link.

with Coupling Pin and Sleeve Locking

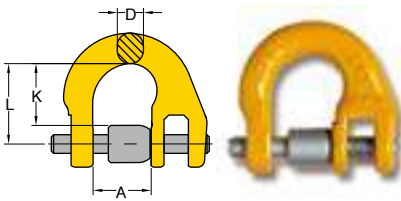

Item No.	Working Load Limit tonnes*	For Grade 80 Chain mm	Dimensions (mm)				N.W. kg
			A	D	K	L	
8-054-06	1.12	6	15	7	17	22	0.1
8-054-07	2.00	7, 8	18	9	22	28	0.1
8-054-10	3.15	10	25	11	26	34	0.2
8-054-13	5.30	13	30	16	35	45	0.4
8-054-16	8.00	16	36	19	38	50	0.6
8-054-20	12.50	18, 20	42	22	46	60	1.1
8-054-22	15.00	22	49	24	59	76	1.7
8-054-26	21.20	26	55	30	62	80	2.7
8-054-32	31.50	32	69	36	79	100	5.0

★ Design factor 4:1 proof tested and certified.
Tested acc. to EN 1677

Coupling Self Locking Hook.

with Coupling Pin and Sleeve

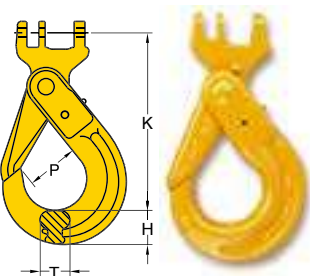

Item No.	Working Load Limit tonnes*	For Grade 80 Chain mm	Dimensions (mm)				N.W. kg
			H	K	P	T	
8-023-06	1.12	6	19	105	29	15	0.5
8-023-07	2.00	7, 8	24	136	34	20	0.8
8-023-10	3.15	10	30	154	44	26	1.3
8-023-13	5.30	13	39	202	55	30	2.8
8-023-16	8.00	16	49	242	60	36	5.7
8-023-20	12.50	18, 20	62	257	90	48	8.5
8-023-22	15.00	22	63	304	80	49	11.0
8-023-26	21.20	26	69	329	99	56	15.0

★ Design factor 4:1 proof tested and certified.
Tested acc. to EN 1677

DNV 2.7-1 TYPE APPROVAL

Offshore Container Lifting Operation





DATM

Offshore Lifting

Offshore Container Lifting Operation.

The Features of YOKE DA™ Offshore Container Lifting Series

YOKE DA™ Series are manufactured to meet the requirements of DNV 2.7-1 for offshore container lifting to fulfill the need for the critical requirements of charpy impact, strength and ductility.

Lower Temperature Demand

YOKE DA™ Series are designed to withstand impacts in extreme environments down to maximum -40°C .

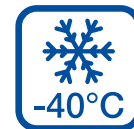

Higher Safety Factors

YOKE DA™ Shackles have a design factor of 6 for Grade 6 Shackles and a design factor of 8 for Grade 8 shackles, and YOKE DA™ Master Link & Assembly have a design factor of 5 to enable them to operate in the harshest environments.

DNV 2.7-1 Specified Test Certificate

Test certificate with material and manufacturing process specified in DNV 2.7-1 for complete traceability.

To perform in the harshest weather and roughest sea conditions, YOKE DA™ Series are specially designed, manufactured and tested for the operating in the offshore container industry.

TYPE APPROVAL C

TYPE APPROVAL CERTIFICATE

DNV GL

Certificate No:
TAS0000074

TYPE APPROVAL CERTIFICATE

Portable Offshore Units

Temperature -40°C
Temperature -40°C

Containers, August 20
Offshore units, Decem
purposes - Deck shackl
ed liftings sets - Par

Portable Offshore U

for DNV
Enger-Helge
Head of

DNV GL

Certificate No:
TAS000011K

m lifting appliances

n on all vessels classed

m lifting appliances

n on all vessels classed

DNV GL

Matteucci
of Section

DNV GL

matteucci@dnvgl.com
Norway

Matteucci
of Section

DNV GL and the Norwegian Class

Page 1 of 4



TYPE APPROVAL CERTIFICATE

Certificate No:
TAS000015G
Revision No:
1

This is to certify:
That the Lifting set component for offshore containers and portable offshore units

with type designation(s)
Couplings - Type: Omega Link OA-018

Issued to:
Yoke Industrial Corp.
Taichung, Taiwan

is found to comply with:
DNV GL standard DNVGL-ST-E271 - 2.7-1 Offshore containers, January 2021
DNV GL standard DNVGL-ST-E273 - 2.7-3 Portable offshore units, April 2018 (Amended January 2020)
ISO 15955-2:2018, Offshore containers and associated liftings sets - Part 2: Design, manufacture and testing of lifting sets
IMO/IBC Circular 686
EN 1577-1 - Components for slings - Safety - Part 1: Forged steel components, Grade 8

Application:
Grade 8, Couplings for offshore container and portable offshore units lifting sets

Issued at Aberdeen, on 2021-02-03

This Certificate is valid until 2026-12-02

DNV local unit: RA066849

Approval Engineer: Elizabeth Legg

for DNV
DNV GL
DNV GL and the Norwegian Class
DNV GL
Ezra Srinivasan Kuppli
Team Lead - Containers

This Certificate is issued to Yoke Industrial Corp. Any significant change in design or construction may render this Certificate invalid. The validity will remain for the Type Approval Certificate and not for the approval of individual components.

LEGAL NOTICE: Users (customer stated in the applicable contract) with the holder of this document, or following from regulatory law, the liability of DNV GL to third parties and their subsidiaries as well as their officers, directors and employees ("DNV") arising from or in connection with the services provided by DNV GL in the scope of this approval or related services, whether in contract or in tort (including negligence), shall be limited to such extent and under any circumstances be limited to DNV GL's liability.

may render this Certificate invalid.
called.

dnvgl.com Page 1 of 3
Graphic are trademarks of DNV GL AS.

Safety is our first priority™

- Quality, Reliability, Innovation -



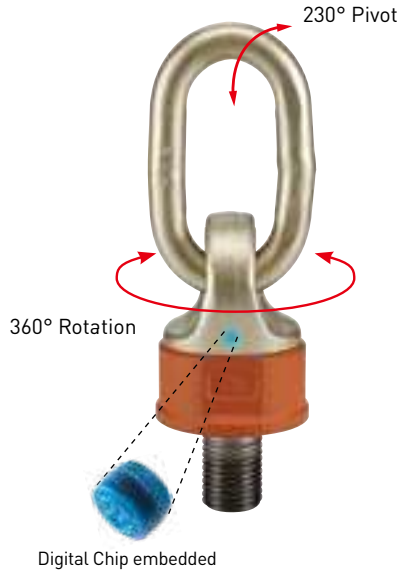
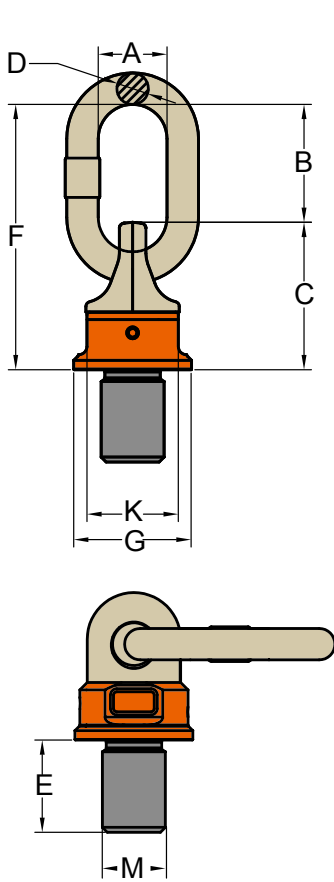

- Pivots to 230°, rotates through 360° due to its unique ball bearing design.
- Manufactured from forged alloy steel, quenched and tempered.
- Tested in accordance with DNV GL-ST-0378.
- Load rated parts are 100% magnaflux crack detected.
- Individual forged parts and batch code links to Test Certificate sheet.
- Bolts are Metric thread.
- Proof tested to 2.5 times the WLL.
- Fatigue rated to 20,000 cycles at 1.5 times the WLL.
- All YOKE Lifting points meet or exceed all the requirements of ASME B30.26.
- Easy to attach or dismantle due to the forged hexagon shaped body of the DA Swivel Point.
- Capable of rotating under load. Do not turn continuously in 90 degree direction at full load.

Digital Chip embedded with Certificate for serial Traceability

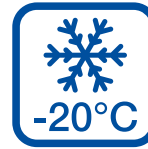

DA Swivel Point

Metric Thread (DA-271)

Item No.	Working Load Limit tonnes	Thread version			Dimensions							Torque in Nm	N.W. kg
		M mm	E mm	Pitch DIN13	G	C	K	F mm	D	B	A		
DA-271-003	0.4	M 8	12	1.25	35	40	30	72	8	32	29	10	0.2
DA-271-004	0.6	M 10	15	1.50	35	40	30	72	8	32	29	10	0.2
DA-271-006	0.7	M 12	18	1.75	40	45	36	95	10	50	35	10	0.3
DA-271-013	1.5	M 16	24	2.00	46	54	41	104	13	50	36	30	0.5
DA-271-020	2.5	M 20	30	2.50	62	68	55	122	13	54	36	70	1.0
DA-271-035	4.0	M 24	36	3.00	78	88	70	154	19	66	41	150	2.2
DA-271-060	6.0	M 30	45	3.50	90	120	80	206	22	86	50	350	4.5
DA-271-080	10.0	M 36	54	4.00	90	120	80	206	22	86	50	410	4.6
DA-271-120	13.0	M 42	63	4.50	98	122	84	235	25	110	67	550	5.5
DA-271-130	14.0	M 48	72	5.00	98	122	84	235	25	110	67	550	6.1
DA-271-140	20.0	M 52	78	5.00	120	150	94	270	32	120	72	750	10.5
DA-271-160	20.0	M 56	84	5.50	120	150	94	270	32	120	72	800	10.7
DA-271-161	20.0	M 64	96	6.00	120	150	94	270	32	120	72	800	11.6

*Design factor 4:1 proof tested and certified.



Kind of attachment

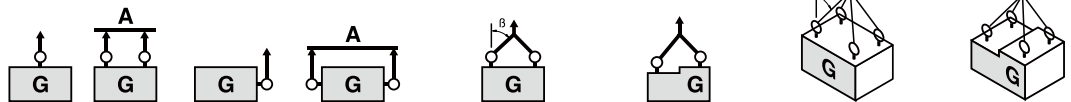

Number of legs		1	2	1	2	2	2	2	3-4	3-4	3-4
Load direction		0°	0°	90°	90°	0-45°	45°- 60°	unsymm.	0 - 45°	45°- 60°	unsymm.
Item No.	Thread	WLL(t)									
DA-271-003	M 8	0.6	1.2	0.4	0.8	0.56	0.4	0.4	0.84	0.60	0.4
DA-271-004	M10	0.9	1.8	0.6	1.2	0.84	0.6	0.6	1.26	0.90	0.6
DA-271-006	M12	1.2	2.4	0.7	1.4	0.98	0.7	0.7	1.47	1.05	0.7
DA-271-013	M16	2.6	5.2	1.5	3.0	2.10	1.5	1.5	3.15	2.25	1.5
DA-271-020	M20	4.0	8.0	2.5	5.0	3.50	2.5	2.5	5.25	3.75	2.5
DA-271-035	M24	7.0	14.0	4.0	8.0	5.60	4.0	4.0	8.40	6.00	4.0
DA-271-060	M30	10.0	20.0	6.0	12.0	8.40	6.0	6.0	12.60	9.00	6.0
DA-271-080	M36	15.0	30.0	10.0	20.0	14.0	10.0	10.0	21.00	15.00	10.0
DA-271-120	M42	17.0	34.0	13.0	26.0	18.2	13.0	13.0	27.30	19.50	13.0
DA-271-130	M48	18.0	36.0	14.0	28.0	19.6	14.0	14.0	29.40	21.00	14.0
DA-271-140	M52	25.0	50.0	20.0	40.0	28.0	20.0	20.0	42.00	30.00	20.0
DA-271-160	M56	28.0	56.0	20.0	40.0	28.0	20.0	20.0	42.00	30.00	20.0
DA-271-161	M64	28.0	56.0	20.0	40.0	28.0	20.0	20.0	42.00	30.00	20.0

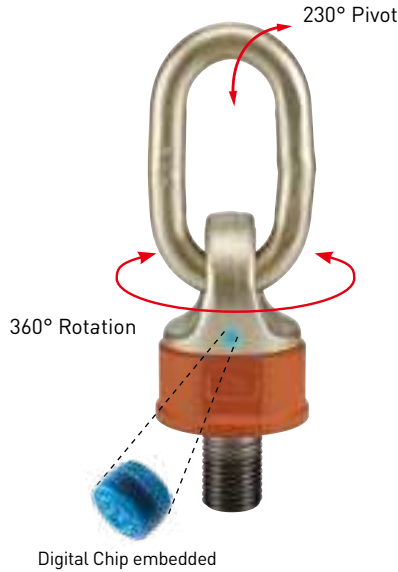
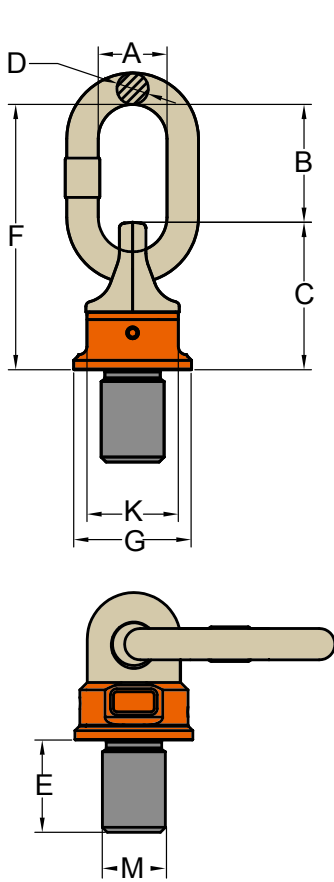

- Pivots to 230°, rotates through 360° due to its unique ball bearing design.
- Manufactured from forged alloy steel, quenched and tempered.
- Tested in accordance with DNV GL-ST-0378.
- Load rated parts are 100% magnaflux crack detected.
- Individual forged parts and batch code links to Test Certificate sheet.
- Bolts are UNC thread.
- Proof tested to 2.5 times the WLL.
- Fatigue rated to 20,000 cycles at 1.5 times the WLL.
- All YOKE Lifting points meet or exceed all the requirements of ASME B30.26.
- Easy to attach or dismantle due to the forged hexagon shaped body of the DA Swivel Point.
- Capable of rotating under load. Do not turn continuously in 90 degree direction at full load.

Digital Chip embedded with Certificate for serial Traceability



DA Swivel Point

UNC Thread (DA-272)

Item No.	Working Load Limit	Thread version			Dimensions							Torque in Nm	N.W.
		M	E	TPI	G	C	K	F	D	B	A		
	tonnes	inch	inch					inch				lbs	
DA-272-006	0.7	1/2	0.75	13UNC	1.57	1.77	1.42	3.74	0.39	1.97	1.38	15	0.7
DA-272-013	1.5	5/8	0.94	11UNC	1.81	2.13	1.61	4.09	0.51	1.97	1.42	45	1.2
DA-272-018	2.0	3/4	1.13	10UNC	1.81	2.68	1.61	4.09	0.51	1.97	1.42	45	1.2
DA-272-020	2.5	7/8	1.31	9UNC	2.44	2.68	2.17	4.80	0.51	2.13	1.42	100	2.2
DA-272-035	4.0	1	1.50	8UNC	3.07	3.46	2.76	6.06	0.75	2.60	1.61	190	4.8
DA-272-060	6.0	1 1/4	1.88	7UNC	3.54	4.72	3.15	8.11	0.87	3.39	1.97	270	9.9
DA-272-080	10.0	1 1/2	2.25	6UNC	3.54	4.72	3.15	8.11	0.87	3.39	1.97	270	10.0
DA-272-120	13.0	1 3/4	2.63	5UNC	3.86	4.80	3.31	9.25	0.98	4.33	2.64	350	12.1
DA-272-130	14.0	2	3.00	4.5UNC	3.86	4.80	3.31	9.25	0.98	4.33	2.64	350	13.5
DA-272-140	20.0	2 1/4	3.38	4.5UNC	4.72	5.91	3.70	10.63	1.26	4.72	2.85	350	23.1
DA-272-160	20.0	2 1/2	3.75	4UNC	4.72	5.91	3.70	10.63	1.26	4.72	2.85	350	23.5

*Design factor 4:1 proof tested and certified.



Kind of attachment																
	Item No.	Thread	WLL(t)	WLL(t)	WLL(t)	WLL(t)	WLL(t)	WLL(t)	WLL(t)	WLL(t)	WLL(t)	WLL(t)	WLL(t)	WLL(t)	WLL(t)	
Number of legs	1	2	1	2	2	2	2	2	3-4	3-4	3-4					
Load direction	0°	0°	90°	90°	0-45°	45°- 60°	unsymm.	0 - 45°	45°- 60°	unsymm.						
DA-272-006	1/2	1.2	2.4	0.7	1.4	0.98	0.7	0.7	1.47	1.05	0.7					
DA-272-013	5/8	2.6	5.2	1.5	3.0	2.10	1.5	1.5	3.15	2.25	1.5					
DA-272-018	3/4	3.6	7.2	2.0	4.0	2.80	2.0	2.0	4.20	3.00	2.0					
DA-272-020	7/8	4.0	8.0	2.5	5.0	3.50	2.5	2.5	5.25	3.75	2.5					
DA-272-035	1	7.0	14.0	4.0	8.0	5.60	4.0	4.0	8.40	6.00	4.0					
DA-272-060	1 1/4	10.0	20.0	6.0	12.0	8.40	6.0	6.0	12.60	9.00	6.0					
DA-272-080	1 1/2	15.0	30.0	10.0	20.0	14.00	10.0	10.0	21.00	15.00	10.0					
DA-272-120	1 3/4	17.0	34.0	13.0	26.0	18.20	13.0	13.0	27.30	19.50	13.0					
DA-272-130	2	18.0	36.0	14.0	28.0	19.60	14.0	14.0	29.40	21.00	14.0					
DA-272-140	2 1/4	25.0	50.0	20.0	40.0	28.00	20.0	20.0	42.00	30.00	20.0					
DA-272-160	2 1/2	28.0	56.0	20.0	40.0	28.00	20.0	20.0	42.00	30.00	20.0					

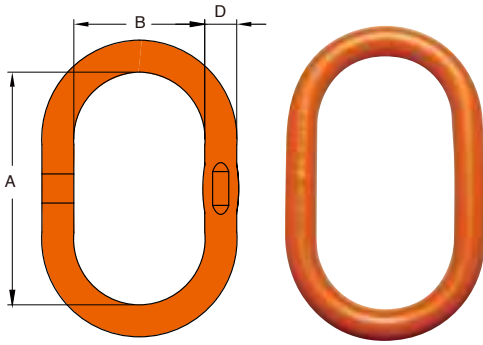

- Welded alloy steel, quenched and tempered.
- Tested and manufactured in accordance with DNV GL ST-2.7-1, EN 1677-4, ASME B30.26.
- Certified by DNV GL ST-2.7-1.
- Fatigue rated to 20,000 cycles at 1.5 times the Working Load Limit (WLL).
- Charpy tested in accordance with DNV GL ST-2.7-1.
- Proof Load tested to 2.5 times the Working Load Limit (WLL).
- Design factor 5:1.
- Charpy test of 42 joules (31ft. lbs.) at -40°C (-40°F) for normal section.
- Charpy test of 27 joules (20ft. lbs.) at -40°C (-40°F) for welded section.

DA Master Link

**DNV GL ST-2.7-1
(Offshore Containers)**



Item No.	Code NO.	WLL 8 0-45° tonnes	Proof Load kN	"can be used to single hook according to DIN 15401 NO."	Dimensions (inch)			N.W. lbs
					D	A	B	
DA-001-13	FD-13	2.8	69	2.5	0.51	4.72	2.36	0.8
DA-001-16	FD-16	4.0	98	6.0	0.63	6.30	3.54	1.6
DA-001-19	FD-19	6.7	164	6.0	0.75	6.30	3.54	2.4
DA-001-22	FD-22	8.9	218	8.0	0.87	7.09	3.94	3.6
DA-001-223	FD-223	6.3	154	16.0	0.87	10.63	5.51	5.0
DA-001-25	FD-25	11.5	282	10.0	0.98	8.27	4.53	5.3
DA-001-251	FD-251	11.5	282	16.0	0.98	10.83	5.71	6.7
DA-001-28	FD-28	13.0	319	16.0	1.10	10.83	5.71	8.5
DA-001-32	FD-32	17.1	419	16.0	1.26	10.83	5.71	11.3
DA-001-36	FD-36	24.0	588	20.0	1.42	11.22	6.10	15.1
DA-001-40	FD-40	28.1	688	20.0	1.57	11.81	6.30	19.7
DA-001-45	FD-45	38.3	938	25.0	1.77	13.39	7.09	28.2
DA-001-50	FD-50	45.0	1103	32.0	1.97	13.78	7.68	36.6

*Welded Master Link *Design Factor 5:1 *Proof tested at 2.5 times the WLL

Item No.	Code NO.	WLL 8 0-45° tonnes	Proof Load kN	"can be used to single hook according to DIN 15401 NO."	Dimensions (mm)			N.W. kg
					D	A	B	
DA-001-13	FD-13	2.8	69	2.5	13	120	60	0.4
DA-001-16	FD-16	4.0	98	6.0	16	160	90	0.7
DA-001-19	FD-19	6.7	164	6.0	19	160	90	1.1
DA-001-22	FD-22	8.9	218	8.0	22	180	100	1.6
DA-001-223	FD-223	6.3	154	16.0	22	270	140	2.3
DA-001-25	FD-25	11.5	282	10.0	25	210	115	2.4
DA-001-251	FD-251	11.5	282	16.0	25	275	145	3.1
DA-001-28	FD-28	13.0	319	16.0	28	275	145	3.9
DA-001-32	FD-32	17.1	419	16.0	32	275	145	5.1
DA-001-36	FD-36	24.0	588	20.0	36	285	155	6.9
DA-001-40	FD-40	28.1	688	20.0	40	300	160	8.9
DA-001-45	FD-45	38.3	938	25.0	45	340	180	12.8
DA-001-50	FD-50	45.0	1103	32.0	50	350	195	16.6

Sub-links SPEC for DA-007. Items in grey area are not for sale individually.

DA-001-131	FD-131	2.8	69	1.6	13	90	50	0.3
DA-001-161	FD-161	4.0	98	4.0	16	140	70	0.6
DA-001-191	FD-191	6.7	164	4.0	19	140	70	0.9
DA-001-221	FD-221	8.9	218	6.0	22	140	70	1.3
DA-001-222	FD-222	8.9	218	6.0	22	162	90	1.5
DA-001-281	FD-281	13.0	319	8.0	28	190	100	2.8
DA-001-282	FD-282	14.5	355	10.0	28	200	110	3.0
DA-001-361	FD-361	24.0	588	16.0	36	275	145	6.6
DA-001-401	FD-401	28.1	688	12.0	40	260	130	7.8

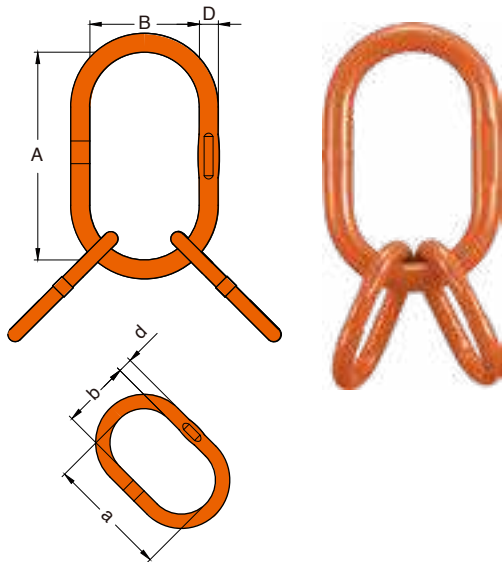

- Welded alloy steel, quenched and tempered.
- Tested and manufactured in accordance with DNV GL ST-2.7-1, EN 1677-4, ASME B30.26.
- Certified by DNV GL ST-2.7-1.
- Fatigue rated to 20,000 cycles at 1.5 times the Working Load Limit (WLL).
- Charpy tested in accordance with DNV GL ST-2.7-1.
- Proof Load tested to 2.5 times the Working Load Limit (WLL).
- Design factor 5:1.
- Charpy test of 42 joules (31ft. lbs.) at -40°C (-40°F) for normal section.
- Charpy test of 27 joules (20ft. lbs.) at -40°C (-40°F) for welded section.

DA Master Link Assembly

**DNV GL ST-2.7-1
(Offshore Containers)**

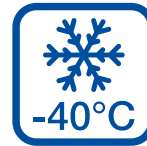

Item No.	Assembled with.	WLL 0-45° tonnes	Proof Load kN	"can be used to single hook according to DIN 15401 NO."	Dimensions (inch)						N.W. lbs
					D	A	B	d	a	b	
DA-007-16	FD-161 +2 FD-131	4.1	100	4	0.63	5.51	2.76	0.51	3.54	1.97	2.7
DA-007-22	FD-222 +2 FD-191	8.9	218	6	0.87	6.38	3.54	0.75	5.51	2.76	7.4
DA-007-221	FD-223 +2 FD-161	6.3	154	16	0.87	10.63	5.51	0.63	5.51	2.76	7.9
DA-007-25	FD-251 +2 FD-19	8.9	218	16	0.98	10.83	5.71	0.75	6.30	3.54	11.5
DA-007-28	FD-28 +2 FD-22	12.9	316	16	1.10	10.83	5.71	0.87	7.09	3.94	15.7
DA-007-281	FD-282 +2 FD-221	14.5	355	10	1.10	7.87	4.33	0.87	5.51	2.76	12.2
DA-007-32	FD-32 +2 FD-25	17.0	417	16	1.26	10.83	5.71	0.98	8.27	4.53	22.0
DA-007-36	FD-361 +2 FD-281	23.6	578	16	1.42	10.83	5.71	1.10	7.48	3.94	26.9
DA-007-40	FD-40 +2 FD-32	28.1	688	20	1.57	11.81	6.30	1.26	10.83	5.71	42.4
DA-007-45	FD-45 +2 FD-36	38.3	938	25	1.77	13.39	7.09	1.42	11.22	6.10	58.4
DA-007-50	FD-50 +2 FD-401	45.0	1103	32	1.97	13.78	7.68	1.57	10.24	5.12	71.1

*Welded Master Link

*Design Factor 5:1

*Proof tested at 2.5 times the WLL

Item No.	Assembled with.	WLL 0-45° tonnes	Proof Load kN	"can be used to single hook according to DIN 15401 NO."	Dimensions (mm)						N.W. kg
					D	A	B	d	a	b	
DA-007-16	FD-161 +2 FD131	4.1	100	4	16	140	70	13	90	50	1.2
DA-007-22	FD-222 +2 FD191	8.9	218	6	22	162	90	19	140	70	3.3
DA-007-221	FD-223 +2 FD161	6.3	154	16	22	270	140	16	140	70	3.6
DA-007-25	FD-251 +2 FD-19	8.9	218	16	25	275	145	19	160	90	5.2
DA-007-28	FD-28 +2 FD-22	12.9	316	16	28	275	145	22	180	100	7.1
DA-007-281	FD-282 +2 FD-221	14.5	355	10	28	200	110	22	140	70	5.5
DA-007-32	FD-32 +2 FD-25	17.0	417	16	32	275	145	25	210	115	10.0
DA-007-36	FD-361 +2 FD-281	23.6	578	16	36	275	145	28	190	100	12.2
DA-007-40	FD-40 +2 FD-32	28.1	688	20	40	300	160	32	275	145	19.2
DA-007-45	FD-45 +2 FD-36	38.3	938	25	45	340	180	36	285	155	26.5
DA-007-50	FD-50 +2 FD-401	45.0	1103	32	50	350	195	40	260	130	32.3

*Welded Master Link

*Design Factor 5:1

*Proof tested at 2.5 times the WLL

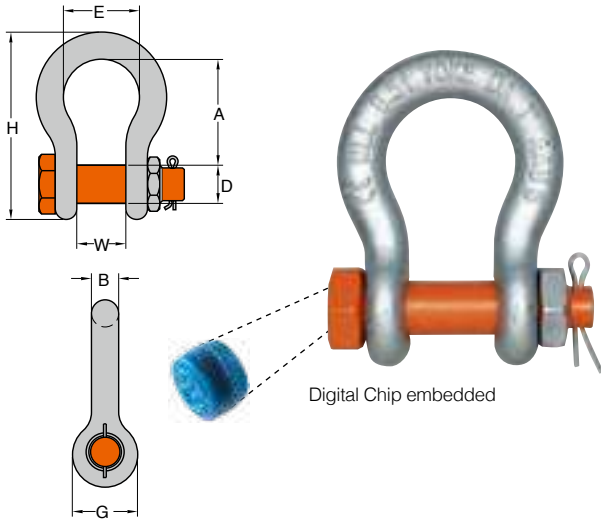

- Forged alloy steel, quenched and tempered.
- Tested and manufactured in accordance with DNV GL ST-2.7-1, DNV GL-ST-0378, EN 13889, ASME B30.26, U.S. Fed. Spec. RR-C-271F Type IVA, Grade A, Class 3.
- Certified by DNV GL ST-2.7-1.
- Fatigue rated to 20,000 cycles at 1.5 times the Working Load Limit (WLL).
- Charpy tested in accordance with DNV GL ST-2.7-1.
- Hot dip galvanized.
- Charpy test of 42 joules (31ft. lbs.) at -40°C (-40°F) for normal section.

DA 838 Shackle

Grade 6

**DNV GL ST-2.7-1
(Offshore Containers)**

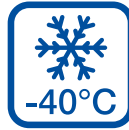

Digital Chip embedded with Certificate for serial Traceability

Item No.	Nominal Size		Working Load Limit	Dimensions (inch)							N.W.
	inch	tonnes*		A	B	D	E	G	H	W	
DA-838-13	1/2	2.00	1.93	0.52	0.63	1.30	1.18	3.34	0.79	0.9	
DA-838-16	5/8	3.25	2.40	0.63	0.75	1.70	1.50	4.17	1.06	1.5	
DA-838-19	3/4	4.75	2.83	0.75	0.87	1.97	1.81	5.04	1.30	2.2	
DA-838-22	7/8	6.50	3.39	0.87	0.98	2.28	2.09	5.91	1.50	3.7	
DA-838-26	1	8.50	3.78	1.02	1.10	2.68	2.40	6.57	1.73	5.3	
DA-838-28	1 1/8	9.50	4.37	1.10	1.26	2.91	2.68	7.52	1.81	7.5	
DA-838-32	1 1/4	12.00	4.84	1.26	1.42	3.30	2.99	8.07	2.12	10.6	
DA-838-36	1 3/8	13.50	5.28	1.42	1.50	3.62	3.31	9.13	2.32	14.3	
DA-838-38	1 1/2	17.00	5.57	1.50	1.69	3.90	3.62	10.00	2.36	19.4	
DA-838-45	1 3/4	25.00	7.00	1.85	2.00	5.00	4.17	12.32	2.87	38.5	
DA-838-50	2	35.00	7.76	2.09	2.24	5.75	4.80	13.66	3.27	53.2	
DA-838-64	2 1/2	** 55.00	10.51	2.62	2.76	7.24	5.91	17.95	4.13	95.7	

*2t to 35t are type approved of DNV 2.7-1. Minimum Ultimate Load is 6 times the Working Load Limit.

Item No.	Nominal Size		Working Load Limit	Dimensions (mm)							N.W.
	mm	tonnes*		A	B	D	E	G	H	W	
DA-838-13	13	2.00	1.93	13.0	16	33	30	85	20	0.4	
DA-838-16	16	3.25	2.40	16.0	19	43	38	106	27	0.7	
DA-838-19	19	4.75	2.83	19.0	22	50	46	126	33	1.0	
DA-838-22	22	6.50	3.39	22.0	25	58	53	148	38	1.7	
DA-838-26	26	8.50	3.78	26.0	28	68	61	166	44	2.4	
DA-838-28	28	9.50	4.37	28.0	32	74	68	190	46	3.4	
DA-838-32	32	12.00	4.84	32.0	36	84	76	210	54	4.8	
DA-838-36	36	13.50	5.28	36.0	38	92	84	232	59	6.5	
DA-838-38	38	17.00	5.57	38.0	43	99	92	254	60	8.8	
DA-838-45	45	25.00	7.00	47.0	51	127	106	313	73	17.5	
DA-838-50	50	35.00	7.76	53.0	57	146	122	347	83	24.2	
DA-838-64	64	** 55.00	10.51	66.5	70	184	150	456	105	43.5	

*2t to 35t are type approved of DNV 2.7-1. Minimum Ultimate Load is 6 times the Working Load Limit.

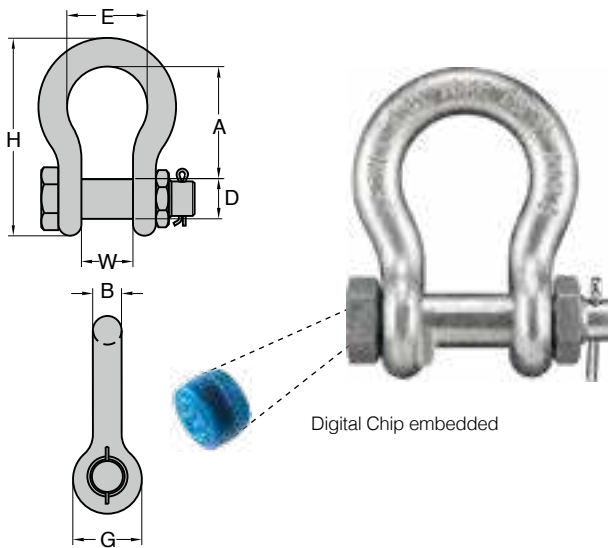

- Forged alloy steel, quenched and tempered.
- Tested and manufactured in accordance with DNV GL ST-2.7-1, DNV GL-ST-0378, EN 13889, ASME B30.26, U.S. Fed. Spec. RR-C-271F Type IVA, Grade A, Class 3.
- Certified by DNV GL ST-2.7-1.
- Fatigue rated to 20,000 cycles at 1.5 times the Working Load Limit (WLL).
- Charpy tested in accordance with DNV GL ST-2.7-1.
- Hot dip galvanized.
- Charpy test of 42 joules (31ft. lbs.) at -40°C (-40°F) for normal section.

DA 808 Shackle

Grade 8

**DNV GL ST-2.7-1
(Offshore Containers)**



Digital Chip embedded with Certificate for serial Traceability

Item No.	Nominal Size	Working Load Limit tonnes*	Dimensions (inch)							N.W. lbs
	inch		A	B	D	E	G	H	W	
DA-808-13	1/2	2.00	1.93	0.52	0.63	1.30	1.18	3.34	0.79	0.9
DA-808-16	5/8	3.25	2.40	0.63	0.75	1.70	1.50	4.17	1.06	1.5
DA-808-19	3/4	4.75	2.83	0.75	0.87	1.97	1.81	5.04	1.30	2.2
DA-808-22	7/8	6.50	3.39	0.87	0.98	2.28	2.09	5.91	1.50	3.7
DA-808-26	2	8.50	3.78	1.02	1.10	2.68	2.40	6.57	1.73	5.3
DA-808-28	1 1/8	9.50	4.37	1.10	1.26	2.91	2.68	7.52	1.81	7.5
DA-808-32	1 1/4	12.00	4.84	1.26	1.42	3.30	2.99	8.07	2.12	10.6
DA-808-36	1 3/8	13.50	5.28	1.42	1.50	3.62	3.31	9.13	2.32	14.3
DA-808-38	1 1/2	17.00	5.57	1.50	1.69	3.90	3.62	10.00	2.36	19.4
DA-808-45	1 3/4	25.00	7.00	1.85	2.00	5.00	4.17	12.32	2.87	38.5
DA-808-50	2	35.00	7.76	2.09	2.24	5.75	4.80	13.66	3.27	53.2
DA-808-64	2 1/2	** 85.00	10.51	2.62	2.76	7.24	5.91	17.95	4.13	95.7
DA-808-76	3	**120.00	12.99	3.11	3.25	7.87	6.61	21.57	5.00	178.2
DA-808-89	3 1/2	**150.00	14.65	3.62	3.76	9.02	7.99	24.65	5.24	264.0
DA-808-100	4	**175.00	14.49	4.09	4.25	10.00	9.02	25.71	5.51	336.6

*2t to 35t are type approved of DNV 2.7-1. Minimum Ultimate Load is 8 times the Working Load Limit.

**85t to 175t meet all requirements of DNV 2.7-1. Minimum Ultimate Load is 5.4 times the Working Load Limit.

Item No.	Nominal Size	Working Load Limit tonnes*	Dimensions (mm)							N.W. kg
	mm		A	B	D	E	G	H	W	
DA-808-13	13	2.00	49	13.0	16.0	33	30	85	20	0.4
DA-808-16	16	3.25	61	16.0	19.0	43	38	106	27	0.7
DA-808-19	19	4.75	72	19.0	22.0	50	46	126	33	1.0
DA-808-22	22	6.50	86	22.0	25.0	58	53	148	38	1.7
DA-808-26	26	8.50	96	26.0	28.0	68	61	166	44	2.4
DA-808-28	28	9.50	111	28.0	32.0	74	68	190	46	3.4
DA-808-32	32	12.00	123	32.0	36.0	84	76	210	54	4.8
DA-808-36	36	13.50	134	36.0	38.0	92	84	232	59	6.5
DA-808-38	38	17.00	146	38.0	43.0	99	92	254	60	8.8
DA-808-45	45	25.00	178	47.0	51.0	127	106	313	73	17.5
DA-808-50	50	35.00	197	53.0	57.0	146	122	347	83	24.2
DA-808-64	64	** 85.00	267	66.5	70.0	184	150	456	105	43.5
DA-808-76	76	**120.00	330	79.0	82.5	200	168	548	127	81.0
DA-808-89	89	**150.00	372	92.0	95.5	229	203	626	133	120.0
DA-808-100	100	**175.00	368	104.0	108.0	254	229	653	140	153.0

*2t to 35t are type approved of DNV 2.7-1. Minimum Ultimate Load is 8 times the Working Load Limit.

**85t to 175t meet all requirements of DNV 2.7-1. Minimum Ultimate Load is 5.4 times the Working Load Limit.

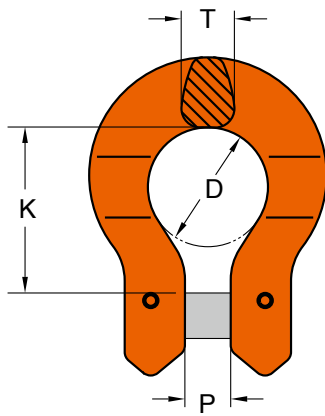

Digital Chip embedded

- Forged alloy steel, quenched and tempered.
- Tested and manufactured in accordance with EN 1677-1, DNVGL-ST-E271 and DNV GL-ST-E273.
- Certified by DNV GL-ST-E271 and DNV GL-ST-E273.
- Fatigue rated to 20,000 cycles at 1.5 times the Working Load Limit (WLL).
- Charpy tested in accordance with DNV GL-ST-E271.
- Design factor 4:1.
- Charpy test of 42 joules (31ft. lbs.) at -20°C (-4°F)

DA Omega Link

**DNV GL ST-2.7-1
(Offshore Containers)**

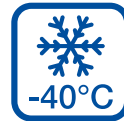

Digital Chip embedded
with Certificate
for serial Traceability

Item No.	Working Load Limit tonnes*	For Grade 80 Chain inch	Dimensions (inch)				N.W. lbs
			D	K	P	T	
DA-018-06	1.12	7/32	0.83	1.15	0.26	0.35	0.2
DA-018-07	2.00	9/32,5/16	1.04	1.41	0.37	0.43	0.4
DA-018-10	3.15	3/8	1.26	1.73	0.46	0.57	0.9
DA-018-13	5.30	1/2	1.65	2.18	0.61	0.67	1.8
DA-018-16	8.00	5/8	1.97	2.73	0.71	0.87	3.5
DA-018-20	12.50	3/4	2.28	3.27	0.85	1.08	4.6

Item No.	Working Load Limit tonnes*	For Grade 80 Chain mm	Dimensions (mm)				N.W. kg
			D	K	P	T	
DA-018-06	1.12	6	21	29	7	9	0.1
DA-018-07	2.00	7,8	27	36	9	11	0.2
DA-018-10	3.15	10	32	44	12	15	0.4
DA-018-13	5.30	13	42	55	16	17	0.8
DA-018-16	8.00	16	50	69	18	22	1.6
DA-018-20	12.50	18,20	58	83	22	28	2.1

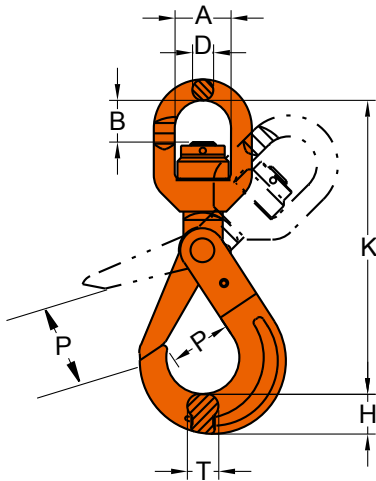

Digital Chip embedded

Digital Chip embedded with Certificate for serial Traceability

- Forged alloy steel, quenched and tempered.
- Tested and manufactured in accordance with EN 1677 and Norsok R002.
- Certified by DNV GL-ST-0378.
- Fatigue rated to 20,000 cycles at 1.5 times the Working Load Limit (WLL).
- Charpy tested in accordance with DNV GL-ST-0378.
- Designed with recessed trigger and ball bearing, providing the locking mechanism being protected against inadvertent opening due to entanglement with any obstruction during lifting.
- Design factor 4:1 and 5:1.
- Latch mechanism is self locking under loading.
- Charpy test of 42 joules (31ft. lbs.) at -20°C (-4°F).

DA Swivel Self Locking Hook

DNV GL-ST-0378
(Offshore and Platform Lifting Appliance)

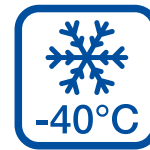

With Ball Bearing, which performs full swivel under load

Item No.	Working Load Limit		Dimensions (inch)							N.W. lbs
	tonnes		A	B	D	H	K	P	T	
	5:1	4:1								
DA-027N-13W	5.3	6.7	2.40	2.52	0.91	1.54	11.61	2.01	1.18	11
DA-027N-16W	8.0	10.0	2.91	3.66	0.98	1.93	14.53	2.36	1.42	18
DA-027N-20	12.8	16.0	2.91	3.23	0.98	2.56	15.24	2.76	2.09	29
DA-027N-22	15.2	19.0	3.82	3.74	1.30	2.48	17.99	3.15	1.93	44
DA-027N-26	21.2	26.5	4.84	4.53	1.65	2.72	21.06	3.90	2.20	72
DA-027N-32	25.2	31.5	4.84	4.53	1.65	3.19	22.95	4.72	2.48	90

Item No.	Working Load Limit		Dimensions (mm)							N.W. kg
	tonnes		A	B	D	H	K	P	T	
	5:1	4:1								
DA-027N-13W	5.3	6.7	61	64	23	39	295	51	30	5.0
DA-027N-16W	8.0	10.0	74	93	25	49	369	60	36	8.1
DA-027N-20	12.8	16.0	74	82	25	65	387	70	53	13.0
DA-027N-22	15.2	19.0	97	95	33	63	457	80	49	20.0
DA-027N-26	21.2	26.5	123	115	42	69	535	99	56	32.7
DA-027N-32	25.2	31.5	123	115	42	81	583	120	63	41.0

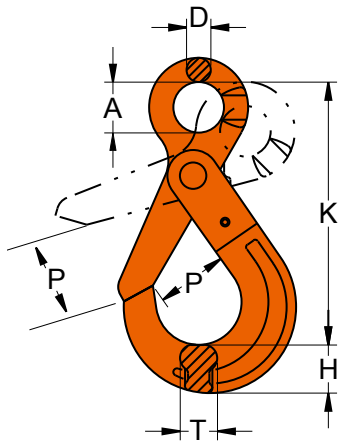

Digital Chip embedded

Digital Chip embedded with Certificate for serial Traceability

- Forged alloy steel, quenched and tempered.
- Tested and manufactured in accordance with EN 1677 and Norsok R002.
- Certified by DNV GL-ST-0378.
- Fatigue rated to 20,000 cycles at 1.5 times the Working Load Limit (WLL).
- Charpy tested in accordance with DNV GL-ST-0378.
- Designed with recessed trigger, providing the locking mechanism being protected against inadvertent opening due to entanglement with any obstruction during lifting.
- Design factor 4:1 and 5:1.
- Latch mechanism is self locking under loading.
- Charpy test of 42 joules (31ft. lbs.) at -20°C (-4°F).

DA Eye Self Locking Hook

DNV GL-ST-0378
(Offshore and Platform Lifting Appliance)

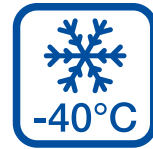

Item No.	Working Load Limit tonnes		Dimensions (inch)						N.W. lbs
	5:1	4:1	A	D	H	K	P	T	
DA-025-13	5.3	6.7	1.57	0.63	1.54	8.15	2.05	1.18	6.6
DA-025-16	8.0	10.0	1.97	0.83	1.93	9.92	2.36	1.42	12.8
DA-025-20	12.8	16.0	2.40	0.91	2.56	11.54	2.76	1.89	22.0
DA-025-22	15.2	19.0	2.76	0.94	2.48	12.56	3.15	1.93	27.5
DA-025-26	21.2	26.5	3.15	0.98	2.72	13.50	3.90	2.20	32.3
DA-025-32	25.2	31.5	3.54	1.10	3.19	15.79	4.72	2.48	57.3

Item No.	Working Load Limit tonnes		Dimensions (mm)						N.W. kg
	5:1	4:1	A	D	H	K	P	T	
DA-025-13	5.3	6.7	40	16	39	207	52	30	3.0
DA-025-16	8.0	10.0	50	21	49	252	60	36	5.8
DA-025-20	12.8	16.0	61	23	65	293	70	48	10.0
DA-025-22	15.2	19.0	70	24	63	319	80	49	12.5
DA-025-26	21.2	26.5	80	25	69	343	99	56	14.7
DA-025-32	25.2	31.5	90	28	81	401	120	63	26.0

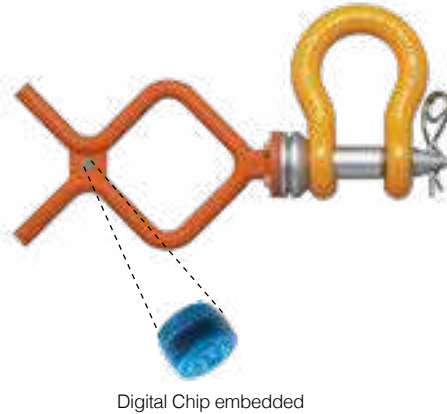
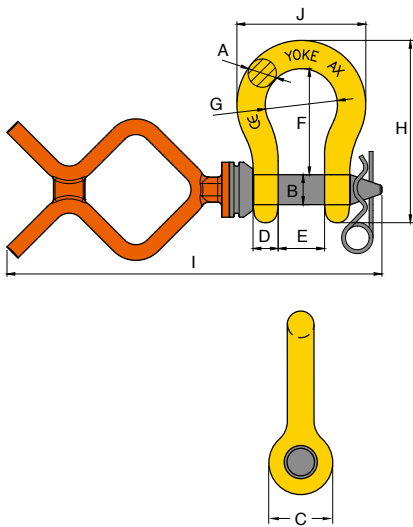

Digital Chip embedded

Digital Chip embedded with Certificate for serial Traceability

- Forged alloy steel, quenched and tempered.
- Designed specifically for ROV application.
- Handles are Carbon Steel.
- Individually stamped with the Working Load Limit.
- Shackle Bows are painted yellow to ensure ease of sight in water.
- Convertible handles on ROV shackle bolts.

ROV Anchor Shackle

with Fishtail-handle and Safety Pin
(ROV: Remotely Operated Vehicle)

Item No.	Nominal Size	Working Load Limit	Dimensions (inch)										N.W. lbs
	in.		tonnes	A	B	C	D	E	F	G	H	I	
8-941-22	7/8	6.5	0.9	1.0	2.1	0.8	1.5	3.4	2.3	5.8	16.5	4.0	9.3
8-941-26	1	8.5	1.0	1.1	2.4	0.9	1.7	3.8	2.7	6.5	16.9	4.7	10.6
8-941-28	1 1/8	9.5	1.1	1.3	2.7	1.1	1.8	4.4	2.9	7.5	17.9	5.1	12.5
8-941-32	1 1/4	12.0	1.3	1.4	3.0	1.2	2.1	4.8	3.3	8.3	18.4	5.8	15.8
8-941-36	1 3/8	13.5	1.4	1.5	3.3	1.3	2.3	5.3	3.6	9.1	18.8	6.5	18.9
8-941-38	1 1/2	17.0	1.5	1.8	3.6	1.4	2.4	5.7	3.9	10.0	19.3	6.9	23.5
8-941-45	1 3/4	25.0	1.9	2.0	4.2	1.7	2.9	7.0	5.0	12.3	21.1	8.7	38.7
8-941-50	2	35.0	2.1	2.2	4.8	2.0	3.3	7.8	5.7	13.7	22.0	9.8	58.1

* Minimum Ultimate Load is 5 times the Working Load Limit.
Maximum Proof Load is 2 times the Working Load Limit.

Item No.	Nominal Size	Working Load Limit	Dimensions (mm)										N.W. kg
	mm		tonnes	A	B	C	D	E	F	G	H	I	
8-941-22	22	6.5	22	26	53	21.5	38.0	86	58	148.0	420	102.0	4.2
8-941-26	26	8.5	26	28	61	23.0	44.0	96	68	166.0	429	120.0	4.8
8-941-28	28	9.5	28	32	68	27.0	46.0	111	74	190.0	454	130.0	5.7
8-941-32	32	12.0	32	36	76	29.5	54.0	121	84	210.0	467	148.0	7.2
8-941-36	36	13.5	36	38	84	32.0	59.0	134	92	232.0	477	164.0	8.6
8-941-38	38	17.0	38	45	92	35.0	60.5	146	99	254.0	489	175.0	10.7
8-941-45	45	25.0	47	50	106	44.0	73.0	178	127	313.0	536	221.0	17.6
8-941-50	50	35.0	53	57	122	50.8	83.5	197	146	347.5	560	247.7	26.4

* Minimum Ultimate Load is 5 times the Working Load Limit.
Maximum Proof Load is 2 times the Working Load Limit.

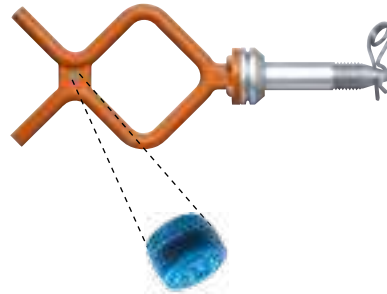
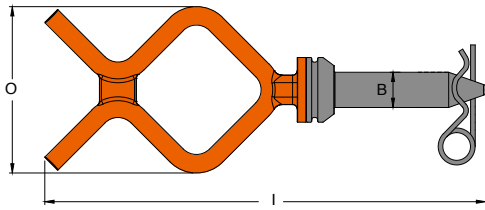

Digital Chip embedded

Digital Chip embedded with Certificate for serial Traceability

- Carbon Steel, quenched and tempered.
- Designed specifically for ROV application.
- Convertible handles on ROV shackle bolts.

ROV Anchor Shackle Fishtail-handle Pin

Item No.	Working Load Limit	Dimensions (inch)			N.W.
	tonnes	B	I	O	lbs
8-941FT-22	6.5	1.02	16.54	7.09	5.9
8-941FT-26	8.5	1.10	16.89	7.09	6.4
8-941FT-28	9.5	1.26	17.87	7.09	7.0
8-941FT-32	12.0	1.42	18.39	7.09	7.7
8-941FT-36	13.5	1.50	18.78	7.09	8.4
8-941FT-38	17.0	1.77	19.25	7.09	9.7
8-941FT-45	25.0	1.97	21.10	7.09	12.3
8-941FT-50	35.0	2.24	22.05	7.09	15.2

Item No.	Working Load Limit	Dimensions (mm)			N.W.
	tonnes	B	I	O	kg
8-941FT-22	6.5	26	420	180	2.7
8-941FT-26	8.5	28	429	180	2.9
8-941FT-28	9.5	32	454	180	3.2
8-941FT-32	12.0	36	467	180	3.5
8-941FT-36	13.5	38	477	180	3.8
8-941FT-38	17.0	45	489	180	4.4
8-941FT-45	25.0	50	536	180	5.6
8-941FT-50	35.0	57	560	180	6.9

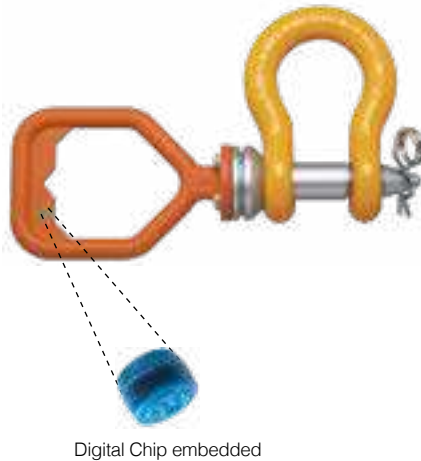
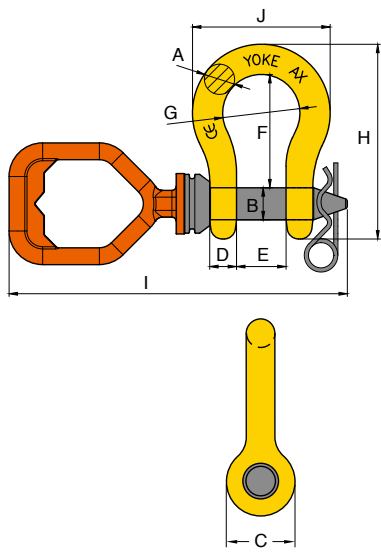

Digital Chip embedded with Certificate for serial Traceability

- Forged alloy steel, quenched and tempered.
- Designed specifically for ROV application.
- Handles are Carbon Steel.
- Individually stamped with the Working Load Limit.
- Shackle Bows are painted yellow to ensure ease of sight in water.
- Convertible handles on ROV shackle bolts.

ROV Anchor Shackle

with D-handle and Safety Pin
(ROV: Remotely Operated Vehicle)

Item No.	Nominal Size	Working Load Limit	Dimensions (inch)										N.W. lbs
			inch	tonnes	A	B	C	D	E	G	H	I	
8-951-22	7/8	6.5	0.9	1.0	2.1	0.9	1.5	2.3	5.8	13.6	4.0	9.9	
8-951-26	1	8.5	1.0	1.1	2.4	0.9	1.7	2.7	6.5	14.0	4.7	11.2	
8-951-28	1 1/8	9.5	1.1	1.3	2.7	1.1	1.8	2.9	7.5	15.0	5.1	13.2	
8-951-32	1 1/4	12.0	1.3	1.4	3.0	1.2	2.1	3.3	8.3	15.5	5.8	16.5	
8-951-36	1 3/8	13.5	1.4	1.5	3.3	1.3	2.3	3.6	9.1	15.9	6.5	19.6	
8-951-38	1 1/2	17.0	1.5	1.8	3.6	1.4	2.4	3.8	10.0	16.3	6.9	24.2	
8-951-45	1 3/4	25.0	1.8	2.0	4.2	1.7	2.9	5.0	12.3	18.2	8.7	39.4	
8-951-50	2	35.0	2.0	2.2	4.8	2.0	3.3	5.7	13.7	19.1	9.8	58.7	

* Minimum Ultimate Load is 5 times the Working Load Limit.
Maximum Proof Load is 2 times the Working Load Limit.

Item No.	Nominal Size	Working Load Limit	Dimensions (mm)										N.W. kg
			mm	tonnes	A	B	C	D	E	G	H	I	
8-951-22	22	6.5	22	26	53	21.5	38.0	58	148.0	346	102.0	4.5	
8-951-26	26	8.5	26	28	61	23.0	44.0	68	166.0	355	120.0	5.1	
8-951-28	28	9.5	28	32	68	27.0	46.0	74	190.0	380	130.0	6.0	
8-951-32	32	12.0	32	36	76	29.5	54.0	84	210.0	393	148.0	7.5	
8-951-36	36	13.5	36	38	84	32.0	59.0	92	232.0	403	164.0	8.9	
8-951-38	38	17.0	38	45	92	35.0	60.5	97	254.0	415	175.0	11.0	
8-951-45	45	25.0	45	50	106	44.0	73.0	127	313.0	462	221.0	17.9	
8-951-50	50	35.0	50	57	122	50.8	83.5	146	347.5	486	247.7	26.7	

* Minimum Ultimate Load is 5 times the Working Load Limit.
Maximum Proof Load is 2 times the Working Load Limit.

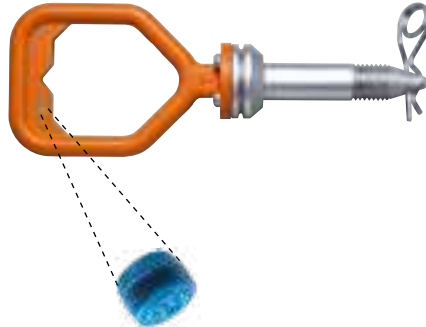
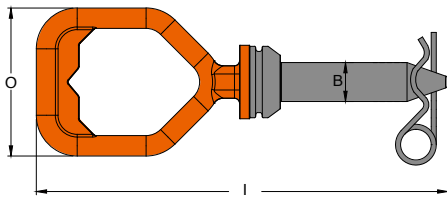

Digital Chip embedded

Digital Chip embedded with Certificate for serial Traceability

- Carbon Steel, quenched and tempered.
- Designed specifically for ROV application.
- Convertible handles on ROV shackle bolts.

ROV Anchor Shackle D-handle Pin

Item No.	Working Load Limit	Dimensions (inch)			N.W.
	tonnes	B	I	O	lbs
8-951DH-22	6.5	1.02	16.54	5.71	5.1
8-951DH-26	8.5	1.10	16.89	5.71	5.5
8-951DH-28	9.5	1.26	17.87	5.71	6.4
8-951DH-32	12.0	1.42	18.39	5.71	6.8
8-951DH-36	13.5	1.50	18.78	5.71	7.5
8-951DH-38	17.0	1.77	19.25	5.71	9.0
8-951DH-45	25.0	1.97	21.10	5.71	11.7
8-951DH-50	35.0	2.24	22.05	5.71	14.3

Item No.	Working Load Limit	Dimensions (mm)			N.W.
	tonnes	B	I	O	kg
8-951DH-22	6.5	26	420	145	2.3
8-951DH-26	8.5	28	429	145	2.5
8-951DH-28	9.5	32	454	145	2.9
8-951DH-32	12.0	36	467	145	3.1
8-951DH-36	13.5	38	477	145	3.4
8-951DH-38	17.0	45	489	145	4.1
8-951DH-45	25.0	50	536	145	5.3
8-951DH-50	35.0	57	560	145	6.5

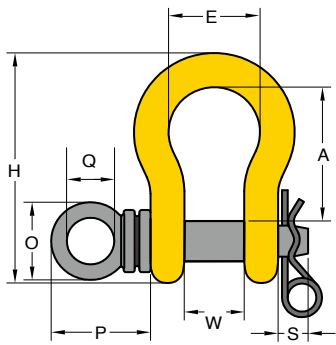

Digital Chip embedded

Digital Chip embedded with Certificate for serial Traceability

ROV: Remotely Operated Vehicle

- Forged alloy steel, quenched and tempered.
- Designed specifically for ROV application.
- Individually stamped with the Working Load Limit.
- Shackle Bows are painted yellow to ensure ease of sight in water.

ROV Anchor Shackle

with Safety Pin

(ROV: Remotely Operated Vehicle)

Item No.	Nominal Size		Working Load Limit tonnes*	Dimensions (inch)									N.W. lbs
	inch	mm		A	E	H	O	P	Q	S	T	W	
8-911-22	7/8	22	6.5	3.39	2.28	5.91	1.96	2.36	1.18	0.87	0.39	1.50	4.0
8-911-26	1	26	8.5	3.78	2.68	6.57	1.96	2.48	1.18	0.91	0.39	1.73	5.5
8-911-28	1 1/8	28	9.5	4.37	2.91	7.52	2.75	3.35	1.38	0.94	0.47	1.81	7.9
8-911-32	1 1/4	32	12.0	4.76	3.30	8.07	2.75	3.35	1.38	1.14	0.47	2.12	10.6
8-911-36	1 3/8	36	13.5	5.28	3.62	9.13	2.95	3.66	1.57	1.22	0.59	2.32	15.0
8-911-38	1 1/2	38	17.0	5.75	3.90	10.00	2.95	3.74	1.57	1.22	0.59	2.36	18.3
8-911-45	1 3/4	45	25.0	7.00	5.00	12.32	3.54	4.48	1.97	1.38	0.71	2.87	36.5
8-911-50	2	50	35.0	7.76	5.75	13.66	4.17	5.19	2.36	1.57	0.78	3.27	51.5

★ Minimum Ultimate Load is 5 times the Working Load Limit.

Maximum Proof Load is 2 times the Working Load Limit.

Item No.	Nominal Size		Working Load Limit tonnes*	Dimensions (mm)									N.W. kg
	inch	mm		A	E	H	O	P	Q	S	T	W	
8-911-22	7/8	22	6.5	86	58	148	50	60	30	22	10	38	1.8
8-911-26	1	26	8.5	96	69	166	50	63	30	23	10	44	2.5
8-911-28	1 1/8	28	9.5	111	74	190	70	85	35	24	12	46	3.6
8-911-32	1 1/4	32	12.0	121	84	210	70	85	35	29	12	54	4.8
8-911-36	1 3/8	36	13.5	134	92	232	75	93	40	31	15	59	6.8
8-911-38	1 1/2	38	17.0	146	99	254	75	95	40	31	15	60	8.3
8-911-45	1 3/4	45	25.0	178	127	313	90	114	50	35	18	73	16.6
8-911-50	2	50	35.0	197	146	347	106	132	60	40	20	83	23.4

★ Minimum Ultimate Load is 5 times the Working Load Limit.

Maximum Proof Load is 2 times the Working Load Limit.

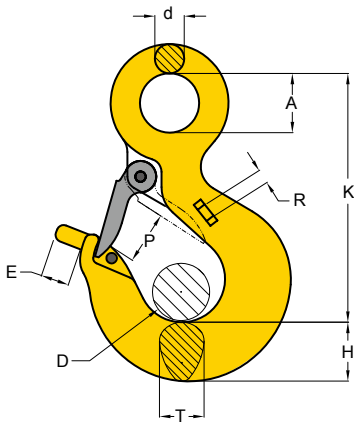

ROV: Remotely Operated Vehicle

- Forged alloy steel, quenched and tempered.
- Designed specifically for ROV application.
- Individually stamped with the Working Load Limit.
- Shackle Bows are painted yellow to ensure ease of sight in water.

Digital Chip embedded with Certificate for serial Traceability

Digital Chip embedded

ROV Eye Sling Hook

(ROV: Remotely Operated Vehicle)

Item No.	Working Load Limit	Dimensions (inch)									N.W. lbs
	tonnes*	A	D	d	E	H	K	P	R	T	
8-921-03	3.0	1.26	0.98	0.59	0.78	1.14	4.80	0.98	0.31	0.95	2.2
8-921-05	5.0	1.57	1.22	0.71	0.78	1.46	5.87	1.22	0.31	1.22	4.6
8-921-07	7.0	2.00	1.54	0.95	0.78	1.89	7.56	1.54	0.31	1.42	8.8
8-921-11	11.0	2.48	2.24	1.10	1.18	2.20	9.13	2.24	0.31	1.85	15.4
8-921-15	15.0	2.84	2.44	1.30	1.18	2.52	10.24	2.44	0.31	2.05	20.7
8-921-22	22.0	3.58	3.19	1.57	1.96	2.91	12.50	3.19	0.39	2.68	40.9
8-921-30	30.0	3.58	3.27	1.77	1.96	3.62	13.66	3.27	0.39	2.99	68.6

★ Minimum Ultimate Load is 4 times the Working Load Limit.
Maximum Proof Load is 2 times the Working Load Limit.

Item No.	Working Load Limit	Dimensions (mm)									N.W. kg
	tonnes*	A	D	d	E	H	K	P	R	T	
8-921-03	3.0	32	25	15	20	29	122	25	8	24	1.0
8-921-05	5.0	40	31	18	20	37	149	31	8	31	2.1
8-921-07	7.0	51	39	24	20	48	192	39	8	36	4.0
8-921-11	11.0	63	57	28	30	56	232	57	8	47	7.0
8-921-15	15.0	72	62	33	30	64	260	62	8	52	9.4
8-921-22	22.0	91	81	40	50	74	318	81	10	68	18.6
8-921-30	30.0	91	83	45	50	92	347	83	10	76	31.2

★ Minimum Ultimate Load is 4 times the Working Load Limit.
Maximum Proof Load is 2 times the Working Load Limit.

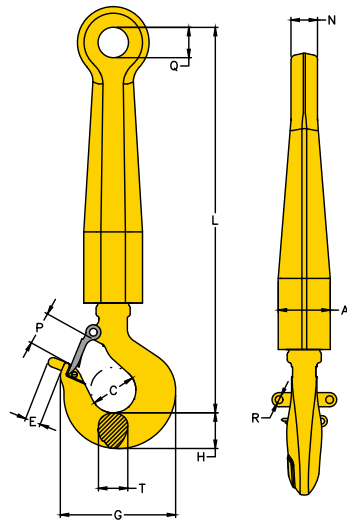

Digital Chip embedded with Certificate for serial Traceability

Digital Chip embedded

- ROV: Remotely Operated Vehicle
- Forged alloy steel, quenched and tempered.
 - Designed specifically for ROV application.
 - Individually stamped with the Working Load Limit.
 - Shackle Bows are painted yellow to ensure ease of sight in water.

ROV Shank Hook

(ROV: Remotely Operated Vehicle)

Item No.	Working Load Limit tonnes*	Dimensions (inch)											N.W. lbs
		A	C	E	G	H	L	N	P	Q	R	T	
8-931-05	5.4	2.17	1.89	0.79	4.80	1.50	16.03	1.10	1.38	1.26	0.32	1.22	13.2
8-931-08	8.0	2.17	2.44	0.79	6.30	1.89	16.97	1.10	1.69	1.26	0.32	1.38	16.7
8-931-11	11.5	2.56	3.03	1.18	7.72	2.21	19.18	1.58	2.40	1.97	0.32	1.85	30.6
8-931-16	16.0	2.56	3.27	1.18	8.70	2.52	19.41	1.58	2.84	1.97	0.32	2.21	35.0
8-931-22	22.0	3.35	4.29	1.97	10.91	2.99	22.25	2.05	3.47	2.56	0.39	2.68	68.2
8-931-32	31.5	3.35	5.00	1.97	13.90	3.58	23.47	2.05	3.50	2.56	0.39	2.99	98.1

★Minimum Ultimate Load is 4 times the Working Load Limit.
Maximum Proof Load is 2 times the Working Load Limit.

Item No.	Working Load Limit tonnes*	Dimensions (mm)											N.W. kg
		A	C	E	G	H	L	N	P	Q	R	T	
8-931-05	5.4	55	48	20	122	38	407	28	35	32	8	31	6.0
8-931-08	8.0	55	62	20	160	48	431	28	43	32	8	35	7.6
8-931-11	11.5	65	77	30	196	56	487	40	61	50	8	47	13.9
8-931-16	16.0	65	83	30	221	64	493	40	72	50	8	56	15.9
8-931-22	22.0	85	109	50	277	76	565	52	88	65	10	68	31.0
8-931-32	31.5	85	127	50	353	91	596	52	89	65	10	76	44.6

★Minimum Ultimate Load is 4 times the Working Load Limit.
Maximum Proof Load is 2 times the Working Load Limit.

YOKE Go Digital, Powered by RiConnect

YOKE's Digital YOKE Snatch Block makes product traceability and Pre-use Check the most simple task ever.

You can obtain and share information through the third party App, RiConnect, by NFC enabled smart phone. Product information, Safe Use Instructions and manufacturer's Certificate (EC Declaration of Conformity/ UK Declaration of Conformity/Declaration of Conformity or Certificate of Conformance or Manufacturer Certificate) can be retrieved simply with a smart phone or tablet.

The unique design of the proprietary wafer-antenna Digital Chip construction, enables Smart phone NFC and RFID Pre-use Check inspection to be more intuitive and efficient.

Tech for Safety!

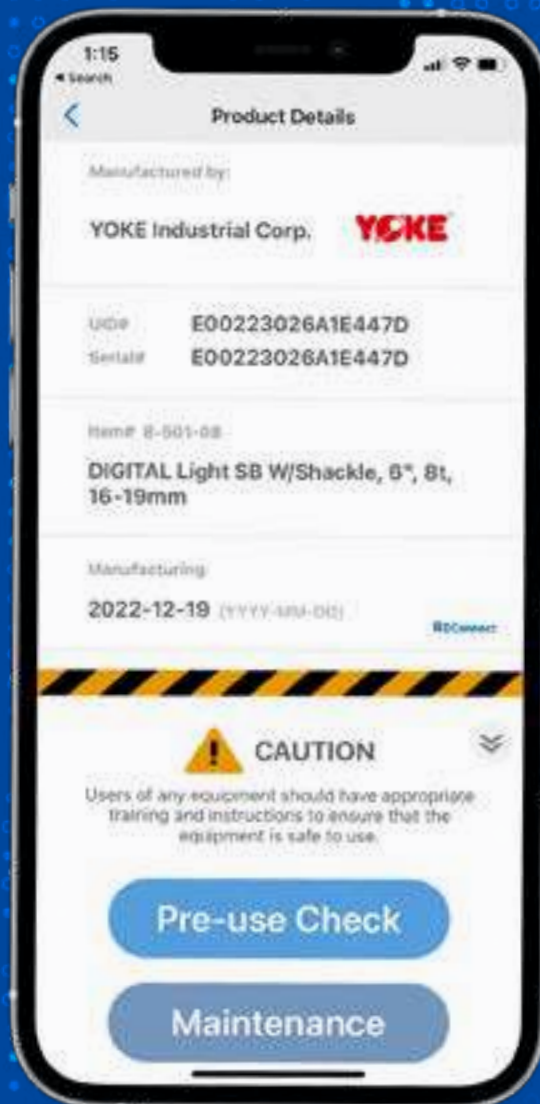

Powered by **RiConnect**

Digital Chip embedded
with Certificate
for serial Traceability





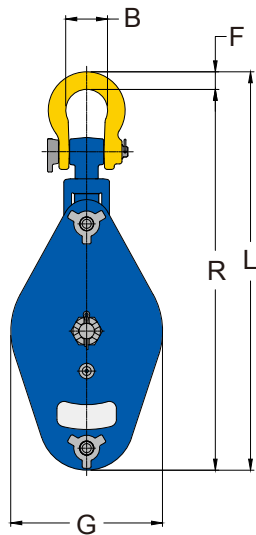

- YOKE Oilfield Hoist Blocks are manufactured of the highest quality alloy steel.
- Available from 4 tonnes to 15 tonnes for wire rope sizes 10mm to 26mm.
- Certified by ABS Type Approval.
- Part number, wire rope size and working load limit are marked on each block.
- Permanent batch codes link to test certificates for easy traceability.
- Supplied with sealed tapered bearings for extended product life and faster line speeds.
- Safety factor 4:1
- Manufactured by an API Q1 Certified facility.

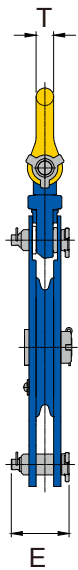

Digital Chip embedded with Certificate for serial Traceability

Oilfield Derrick Block

Item No.	Sheave Dia.	Bearing Type	Wire Rope Size	Working Load Limit	Dimensions							N.W.	
					B	E	F	G	L	R	T	lbs	kg
	inch		mm	tonnes				mm					
8-591-0408	8	**TB	10-13	4	34	82	19	226	550	531	19	35	16
8-591-0810-13	10	TB	10-13	8	64	105	32	276	725	693	32	55	25
8-591-0810-15	10	TB	13-15	8	64	105	32	276	725	693	32	55	25
8-591-1214-16	14	TB	16	12	64	105	32	378	823	791	32	95	43
8-591-1214-19	14	TB	19	12	64	105	32	378	823	791	32	95	43
8-591-1516-22	16	TB	22	15	80	137	44	433	931	975	39	150	68
8-591-1516-26	16	TB	26	15	80	137	44	433	931	975	39	150	68

*Minimum Ultimate Load is 4 times the Working Load Limit.

**TB: Tapered Bearings





Superior Design Features of YOKE Snatch Blocks

- ✓ YSB sheaves are closed die drop forged steel. Available in size from 3" to 12" satisfying your heavy duty applications.
- ✓ Groove bottom hardened to 35 Rc maximizes durability of Snatch Blocks.

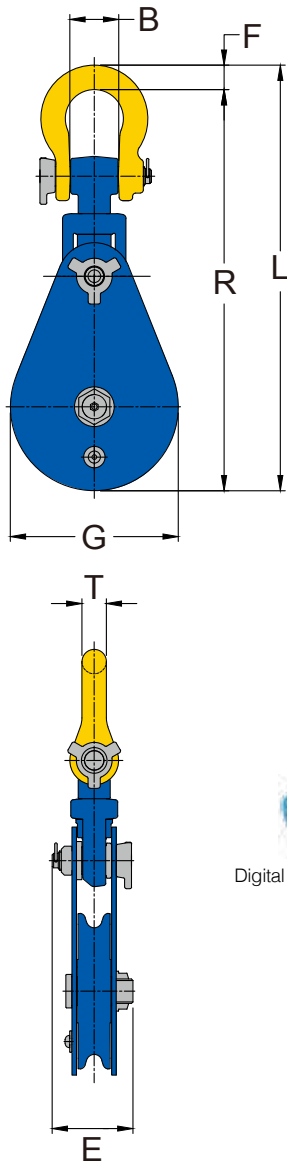

8-501-08 and up

Digital Chip embedded

Digital Chip embedded with Certificate for serial Traceability



8-501-02
8-501-04

Digital Chip embedded

- YOKE Light Snatch Blocks are manufactured of the highest quality tensile steel.
- Available from 2 tonnes to 8 tonnes, for wire rope sizes 8mm to 19mm.
- Certified by CCS, UKCA Type Approval.
- Part number, wire rope size and working load limit are marked on each block.
- Permanent batch codes link to test certificates for easy traceability.
- Supplied with bronze bushings and 3.0"-14" with pressure lube fittings.
- Meets or exceeds all requirements of ASME B30.26.
- Safety factor 4:1
- Fatigue rated

Light Snatch Block with Shackle

Item No.	Sheave Dia. inch	Bearing Type	Wire Rope Size mm	Working Load Limit tonnes	Dimensions							N.W.	
					B	E	F	G	L	R	T	lbs	kg
8-501-02	3.0	**BB	8-10	2	19	64	11	75	228	217	11	4	2
8-501-04	4.5	BB	10-13	4	34	82	19	108	355	336	19	13	6
8-501-08	6.0	BB	16-19	8	64	112	32	152	483	451	32	29	13
8-501-0808	8.0	BB	16-19	8	64	112	32	220	557	525	32	44	20
8-501-0810	10.0	BB	16-19	8	64	112	32	264	598	566	32	46	21
8-501-0812-16	12.0	BB	16	8	64	112	32	310	658	626	32	49	22
8-501-0812-19	12.0	BB	19	8	64	112	32	310	658	626	32	49	22
8-501-0814-16	14.0	BB	16	8	64	112	32	356	696	664	32	56	25
8-501-0814-19	14.0	BB	19	8	64	112	32	356	696	664	32	56	25

*Minimum Ultimate Load is 4 times the Working Load Limit.

**BB: Bronze Bushing

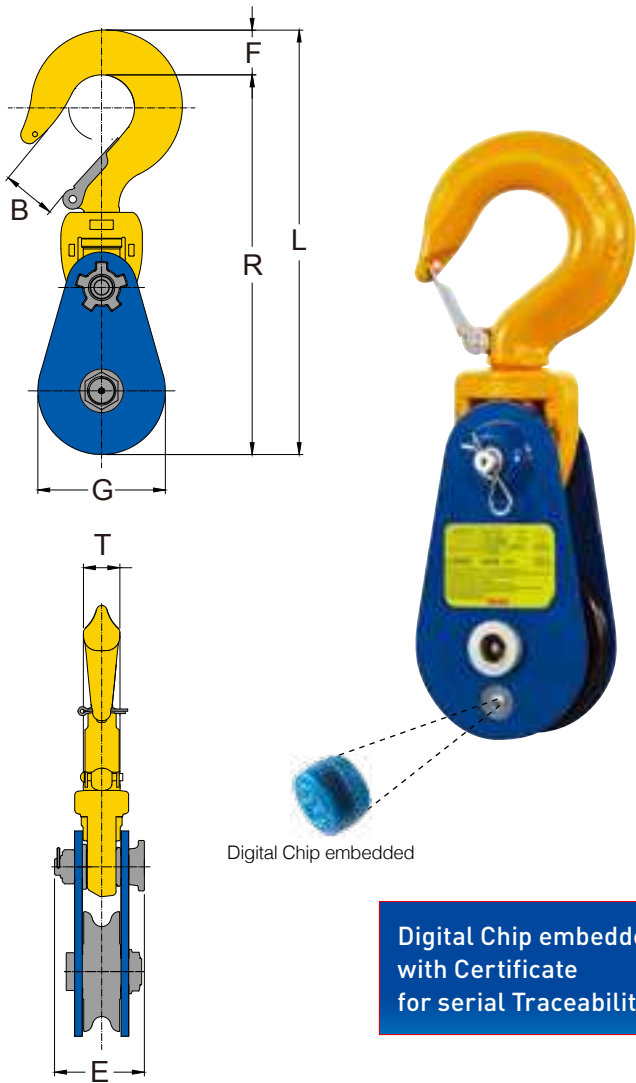

Digital Chip embedded with Certificate for serial Traceability

- YOKE Light Snatch Blocks are manufactured of the highest quality tensile steel.
- Available from 2 tonnes to 8 tonnes, for wire rope sizes 8mm to 19mm.
- Certified by ABS Type Approval.
- Part number, wire rope size and working load limit are marked on each block.
- Permanent batch codes link to test certificates for easy traceability.
- Supplied with bronze bushings and 3.0"-14" with pressure lube fittings.
- Meets or exceeds all requirements of ASME B30.26.
- Safety factor 4:1
- Fatigue rated

Light Snatch Block with Hook

Item No.	Sheave Dia.	Bearing Type	Wire Rope Size	Working Load Limit	Dimensions							N.W.	
					B	E	F	G	L	R	T	lbs	kg
	inch		mm	tonnes				mm					
8-502-02	3.0	**BB	8-10	2	27	64	26	75	250	224	20	7	3
8-502-04	4.5	BB	10-13	4	34	82	35	107	355	320	31	13	6
8-502-08	6.0	BB	16-19	8	48	112	61	152	488	427	40	29	13
8-502-0808	8.0	BB	16-19	8	48	112	61	220	563	502	40	42	19
8-502-0810	10.0	BB	16-19	8	48	112	61	264	603	542	40	45	21
8-502-0812-16	12.0	BB	16	8	48	112	61	310	666	605	40	48	22
8-502-0812-19	12.0	BB	19	8	48	112	61	310	666	605	40	48	22
8-502-0814-16	14.0	BB	16	8	48	112	61	356	701	640	40	55	25
8-502-0814-19	14.0	BB	19	8	48	112	61	356	701	640	40	55	25

*Minimum Ultimate Load is 4 times the Working Load Limit.

**BB: Bronze Bushing

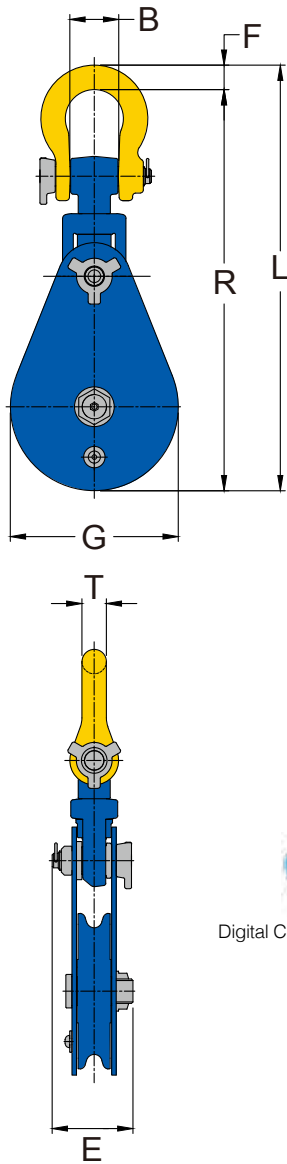

Digital Chip embedded

Digital Chip embedded with Certificate for serial Traceability

- YOKE Forged Snatch Blocks are manufactured of the highest quality forged alloy steel.
- Available from 12 tonnes to 15 tonnes, for wire rope sizes 19mm to 22mm.
- Certified by ABS Type Approval.
- Part number, wire rope size and working load limit are marked on each block.
- Permanent batch codes link to test certificates for easy traceability.
- Supplied with bronze bushings and pressure lube fittings.
- Meets or exceeds all requirements of ASME B30.26.
- Safety factor 4:1
- Fatigue rated

Forged Snatch Block with Shackle

Item No.	Sheave Dia.	Bearing Type	Wire Rope Size	Working Load Limit	Dimensions							N.W.	
					B	E	F	G	L	R	T	lbs	kg
	inch		mm	tonnes				mm					
8-541-12	6	**BB	19-22	12	80	141	44	166	540	496	44	52	24
8-541-15	8	BB	19-22	15	80	141	44	220	589	545	44	61	28
8-541-1510	10	BB	19-22	15	80	141	44	280	714	670	44	90	41

*Minimum Ultimate Load is 4 times the Working Load Limit.

**BB: Bronze Bushing

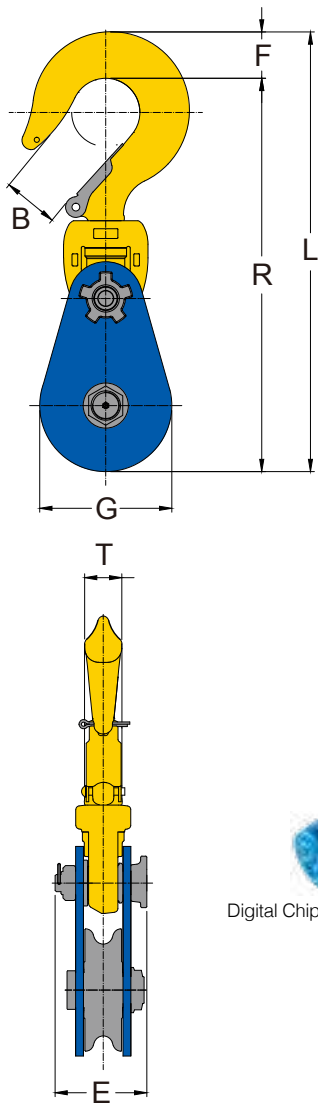

Digital Chip embedded

Digital Chip embedded with Certificate for serial Traceability

- YOKE Forged Snatch Blocks are manufactured of the highest quality forged alloy steel.
- Available from 12 tonnes to 15 tonnes, for wire rope sizes 19mm to 22mm.
- Part number, wire rope size and working load limit are marked on each block.
- Permanent batch codes link to test certificates for easy traceability.
- Supplied with bronze bushings and pressure lube fittings.
- Meets or exceeds all requirements of ASME B30.26.
- Safety factor 4:1
- Fatigue rated

Forged Snatch Block with Hook

Item No.	Sheave Dia.	Bearing Type	Wire Rope Size	Working Load Limit	Dimensions							N.W.	
					B	E	F	G	L	R	T	lbs	kg
	inch		mm	tonnes				mm					
8-542-12	6	**BB	19-22	12	60	140	67	166	565	498	50	52	24
8-542-15	8	BB	19-22	15	60	140	67	220	614	547	50	61	28
8-542-1510	10	BB	19-22	15	60	140	67	280	739	672	50	90	41

*Minimum Ultimate Load is 4 times the Working Load Limit.

**BB: Bronze Bushing

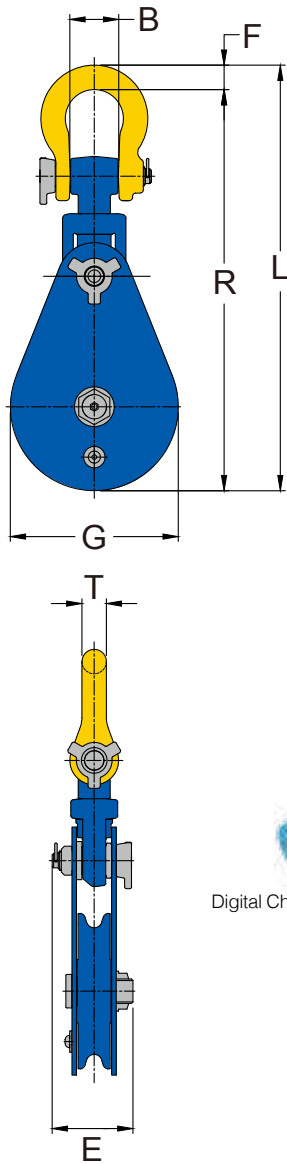

Digital Chip embedded with Certificate for serial Traceability

- YOKE Super Snatch Blocks are manufactured of the highest quality tensile steel.
- Available for 20 tonnes, for wire rope sizes 25mm to 29mm.
- Certified by ABS, UKCA Type Approval.
- Part number, wire rope size and working load limit are marked on each block.
- Permanent batch codes link to test certificates for easy traceability.
- Supplied with bronze bushings and pressure lube fittings.
- Meets or exceeds all requirements of ASME B30.26.
- Safety factor 4:1
- Fatigue rated

Super Snatch Block with Shackle

Item No.	Sheave Dia. inch	Bearing Type	Wire Rope Size mm	Working Load Limit tonnes	Dimensions							N.W.	
					B	E	F	G	L	R	T	lbs	kg
8-551-20	8	**BB	25-29	20	93	146	55	216	671	616	51	92	42
8-551-2010	10	BB	25-29	20	93	146	55	280	778	723	51	119	54
8-551-2012-25	12	BB	25	20	93	146	55	330	833	778	51	139	63
8-551-2012-29	12	BB	29	20	93	146	55	330	833	778	51	139	63

*Minimum Ultimate Load is 4 times the Working Load Limit.

**BB: Bronze Bushing

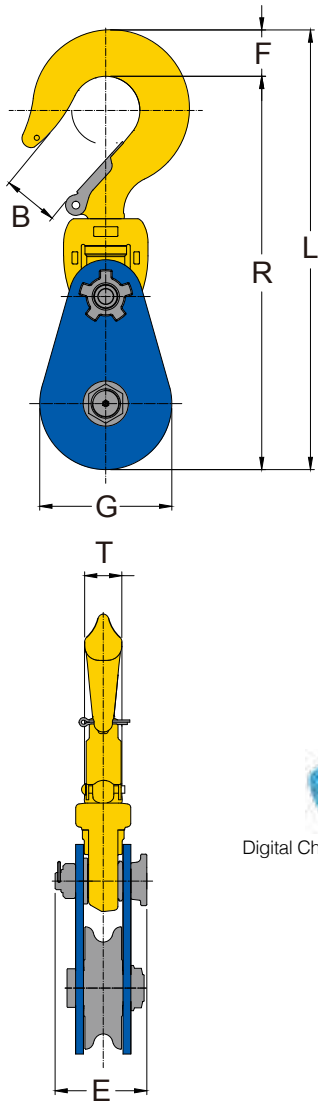

Digital Chip embedded

Digital Chip embedded with Certificate for serial Traceability

- YOKE Super Snatch Blocks are manufactured of the highest quality tensile steel.
- Available from 20 tonnes to 30 tonnes, for wire rope sizes 25mm to 32mm.
- Part number, wire rope size and working load limit are marked on each block.
- Permanent batch codes link to test certificates for easy traceability.
- Supplied with bronze bushings and pressure lube fittings.
- Meets or exceeds all requirements of ASME B30.26.
- Safety factor 4:1
- Fatigue rated

Super Snatch Block with Hook

Item No.	Sheave Dia.	Bearing Type	Wire Rope Size	Working Load Limit	Dimensions							N.W.	
					B	E	F	G	L	R	T	lbs	kg
	inch		mm	tonnes				mm					
8-552-20	8	**BB	25-29	20	90	146	76	216	719	643	61	90	41
8-552-2010	10	BB	25-29	20	90	152	76	280	826	750	61	117	53
8-552-2012-25	12	BB	25	20	90	146	76	330	881	805	61	139	63
8-552-2012-29	12	BB	29	20	90	146	76	330	881	805	61	139	63

*Minimum Ultimate Load is 4 times the Working Load Limit.

**BB: Bronze Bushing

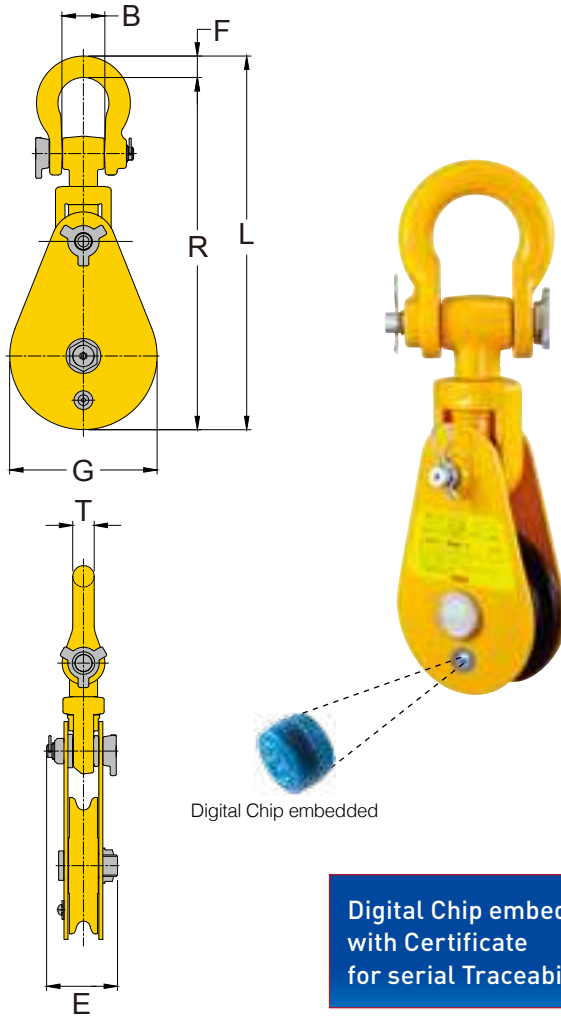

- YOKE Alloy Snatch Blocks are manufactured of the highest quality alloy steel.
- Available in 12 tonnes, for wire rope sizes 19mm to 22mm.
- Certified by ABS Type Approval.
- Part number, wire rope size and working load limit are marked on each block.
- Permanent batch codes link to test certificates for easy traceability.
- Supplied with bronze bushings and pressure lube fittings.
- Meets or exceeds all requirements of ASME B30.26.
- Safety factor 4:1
- Fatigue rated

Alloy Snatch Block with Shackle

Item No.	Sheave Dia.	Bearing Type	Wire Rope Size	Working Load Limit	Dimensions							N.W.	
					B	E	F	G	L	R	T	lbs	kg
	inch		mm	tonnes				mm					
8-561-12	6	**BB	19-22	12	64	112	32	152	483	451	32	28	13
8-561-1208	8	BB	19-22	12	64	112	32	220	554	522	32	37	17
8-561-1210	10	BB	19-22	12	64	112	32	264	598	566	32	46	21

*Minimum Ultimate Load is 4 times the Working Load Limit.

**BB: Bronze Bushing

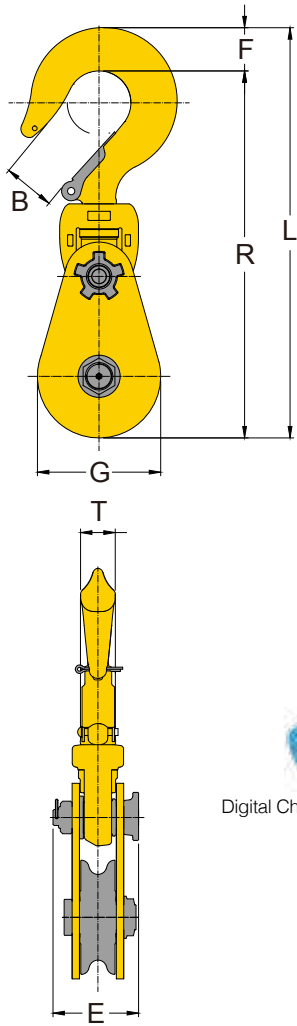

Digital Chip embedded

Digital Chip embedded with Certificate for serial Traceability

- YOKE Alloy Snatch Blocks are manufactured of the highest quality alloy steel.
- Available in 12 tonnes, for wire rope sizes 19mm to 22mm.
- Part number, wire rope size and working load limit are marked on each block.
- Permanent batch codes link to test certificates for easy traceability.
- Supplied with bronze bushings and pressure lube fittings.
- Meets or exceeds all requirements of ASME B30.26.
- Safety factor 4:1
- Fatigue rated

Alloy Snatch Block with Hook

Item No.	Sheave Dia.	Bearing Type	Wire Rope Size	Working Load Limit	Dimensions							N.W.	
					B	E	F	G	L	R	T	lbs	kg
	inch		mm	tonnes				mm					
8-562-12	6	**BB	19-22	12	48	112	61	152	488	427	40	31	14
8-562-1208	8	BB	19-22	12	48	112	61	220	559	498	40	37	17
8-562-1210	10	BB	19-22	12	48	112	61	264	604	543	40	46	21

*Minimum Ultimate Load is 4 times the Working Load Limit.

**BB: Bronze Bushing



Digital Chip embedded

Digital Chip embedded with Certificate for serial Traceability

- YOKE Hay Fork Pulley features one piece pressed steel shell and forged hook.
- Rounded edges to prevent rope damages.
- Supplied with bronze bushings and pressure lube fittings.
- Manila rope and wire line applications

Hay Fork Pulley with Swivel Hook

Item No.	Working Load Limit	Sheave Dia.	Rope Code	Wire Rope Size	N.W.	
	tonnes*			inch	mm	lbs
8-512-01MR	1	4.5	Manila Rope	32	9	4
8-512-01WL	1	4.5	Wire Line	10 - 13	9	4
8-512-02MR	2	6.0	Manila Rope	38	15	7
8-512-02WL	2	6.0	Wire Line	16	15	7

*Minimum Ultimate Load is 4 times the Working Load Limit.



Digital Chip embedded

Digital Chip embedded with Certificate for serial Traceability

- YOKE Hay Fork Pulley features one piece pressed steel shell and forged hook.
- Rounded edges to prevent rope damages.
- Supplied with bronze bushings and pressure lube fittings.
- Manila rope and wire line applications

Hay Fork Pulley with Swivel Eye

Item No.	Working Load Limit	Sheave Dia.	Rope Code	Wire Rope Size	N.W.	
	tonnes*			inch	mm	lbs
8-514-01MR	1	4.5	Manila Rope	32	7	3
8-514-01WL	1	4.5	Wire Line	10 - 13	7	3
8-514-02MR	2	6.0	Manila Rope	38	13	6
8-514-02WL	2	6.0	Wire Line	16	13	6

*Minimum Ultimate Load is 4 times the Working Load Limit.



Digital Chip embedded

Digital Chip embedded with Certificate for serial Traceability

- YOKE Hay Fork Pulley features one piece pressed steel shell and forged hook.
- Rounded edges to prevent rope damages.
- Supplied with bronze bushings and pressure lube fittings.
- Manila rope and wire line applications

Hay Fork Pulley with Swivel Eye

Item No.	Working Load Limit	Sheave Dia.	Rope Code	Wire Rope Size	N.W.	
	tonnes*			inch	mm	lbs
8-515-02WL	2	8	Wire Line	13	13	4

*Minimum Ultimate Load is 4 times the Working Load Limit.





- All parts are forged: swivel eye, side plates and sheave.
- Hot dipped galvanized finish provides corrosive resistance in salt water environment.
- Supplied with needle bearings and pressure lube fittings.
- Individually tested for maximum safety.

Trawl Block

with Swivel Eye

Item No.	Sheave Dimensions (inch)		Bearing Type	Working Load Limit	N.W.	
	inch	Rim Thickness			t*	lbs
8-521-05	6	2 3/4	Needle bearing	5	27	12

★ Minimum Ultimate Load is 4 times the Working Load Limit.



- All parts are forged: swivel eye, side plates and sheave.
- Hot dipped galvanized finish provides corrosive resistance in salt water environment.
- Supplied with tapered bearings and pressure lube fittings.
- Individually tested for maximum safety.

Trawl Block

with Swivel Eye

Item No.	Sheave Dimensions (inch)		Bearing Type	Working Load Limit	N.W.	
	inch	Rim Thickness			t*	lbs
8-523-10	8	2 7/8	Tapered bearing	10	44	20

★ Minimum Ultimate Load is 4 times the Working Load Limit.



- Forged swivel eye and sheave, pressed side plates with extra throat opening allowing nets and fittings to pass through.
- Hot dipped galvanized finish provides corrosive resistance in salt water environment.
- Supplied with bronze bushing and pressure lube fittings.
- Individually tested for maximum safety.

Trawl Block with Swivel Eye

Item No.	Sheave Dimensions (inch)		Bearing Type	Working Load Limit t*	N.W.	
	inch	Rim Thickness			lbs	kg
8-522-05	6	2 3/4	Bronze bushing	5	32	15

★ Minimum Ultimate Load is 4 times the Working Load Limit.



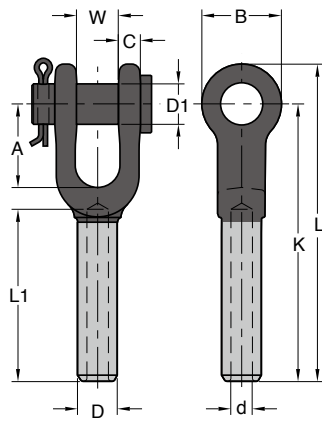

- YOKE 8-731 Opened Swage Sockets are forged from special bar quality carbon steel with very finest hardness controlled by spheroidize annealing.
- YOKE Swage Sockets properly applied have an efficiency rating of 100% based on the catalog strength of wire rope.
- YOKE Swage Sockets are recommended for use with 6x19, 6x37, and IWRC wire rope. They are approved for use with galvanized bridge rope.
- YOKE Swage Sockets are not recommended for use on fiber core or lang lay rope.
- Galvanized finish.

All slings swaged with sockets shall be proof loaded in accordance with ASME B30.9

Forged Open Swage Socket with Round Pin

Item No.		Rope Size	Before Swage Dimensions (inch)										Max. After Swage Dim.	N.W.
S.C.*	Galvanized	inch	A	B	C	D	D1	d	K	L	L1	W	inch	lbs
8-731-06	8-731-06G	1/4	1.50	1.38	0.35	0.50	0.69	0.27	4.02	4.80	2.17	0.67	0.46	0.7
8-731-08	8-731-08G	5/16	1.77	1.65	0.47	0.77	0.81	0.34	5.31	6.26	3.15	0.79	0.71	1.5
8-731-10	8-731-10G	3/8	1.77	1.65	0.47	0.77	0.81	0.41	5.31	6.26	3.15	0.79	0.71	1.3
8-731-11	8-731-11G	7/16	1.96	2.00	0.55	0.98	1.00	0.48	6.85	7.83	4.33	1.00	0.91	2.6
8-731-13	8-731-13G	1/2	1.96	2.00	0.55	0.98	1.00	0.55	6.85	7.83	4.33	1.00	0.91	2.4
8-731-14	8-731-14G	9/16	2.25	2.36	0.68	1.25	1.19	0.62	8.27	9.45	5.31	1.22	1.16	4.6
8-731-16	8-731-16G	5/8	2.25	2.36	0.68	1.25	1.19	0.67	8.27	9.45	5.31	1.22	1.16	4.6
8-731-19	8-731-19G	3/4	2.75	2.75	0.79	1.55	1.38	0.82	10.07	11.61	6.34	1.50	1.42	8.4
8-731-22	8-731-22G	7/8	3.23	3.15	0.94	1.70	1.63	0.94	11.81	13.39	7.44	1.77	1.55	11.9
8-731-26	8-731-26G	1	3.86	3.94	1.02	1.98	2.00	1.06	13.58	15.55	8.50	2.00	1.80	17.8
8-731-28	8-731-28G	1 1/8	4.26	4.06	1.19	2.25	2.20	1.19	15.08	17.40	9.37	2.25	2.05	27.5
8-731-32	8-731-32G	1 1/4	4.72	4.45	1.34	2.53	2.25	1.33	16.50	19.06	10.59	2.48	2.30	38.5
8-731-36	8-731-36G	1 3/8	5.20	5.00	1.38	2.80	2.50	1.45	18.23	21.02	11.69	2.52	2.56	46
8-731-38	8-731-38G	1 1/2	5.75	5.51	1.69	3.08	2.52	1.61	19.75	22.88	12.40	3.00	2.81	66
8-731-45	8-731-45G	1 3/4	6.75	6.70	2.11	3.39	3.50	1.86	23.00	26.53	14.88	3.50	3.06	88.7
8-731-50	8-731-50G	2	8.00	8.00	2.37	3.94	3.75	2.11	26.88	31.44	16.96	4.00	3.56	146.1

★S.C. = Self Colored.

Item No.		Rope Size	Before Swage Dimensions (mm)										Max. After Swage Dim.	N.W.
S.C.*	Galvanized	mm	A	B	C	D	D1	d	K	L	L1	W	mm	kg
8-731-06	8-731-06G	6- 7	38	35	9	13	18	7	102	122	55	17	12	0.3
8-731-08	8-731-08G	8	45	42	12	20	21	9	135	159	80	20	18	0.7
8-731-10	8-731-10G	9-10	45	42	12	20	21	10	135	159	80	20	18	0.6
8-731-11	8-731-11G	11-12	50	50	14	25	25	12	174	199	110	25	23	1.2
8-731-13	8-731-13G	13	50	50	14	25	25	14	174	199	110	25	23	1.1
8-731-14	8-731-14G	14-15	70	60	17	32	30	16	210	240	135	31	30	2.1
8-731-16	8-731-16G	16	57	60	17	32	30	17	210	240	135	31	30	2.1
8-731-19	8-731-19G	18-20	70	70	20	39	35	21	256	295	161	38	36	3.8
8-731-22	8-731-22G	22-23	82	80	24	43	41	24	300	340	189	45	40	5.4
8-731-26	8-731-26G	24-25	98	100	26	50	51	27	345	395	216	50	46	8.1
8-731-28	8-731-28G	28	108	103	30	57	57	30	383	442	238	57	52	12.5
8-731-32	8-731-32G	32	120	113	34	64	64	34	419	484	269	63	59	17.5
8-731-36	8-731-36G	35-36	132	127	35	71	64	37	463	534	297	64	65	20.9
8-731-38	8-731-38G	38	146	140	43	78	70	41	502	581	315	76	72	30.0
8-731-45	8-731-45G	44-45	171	170	54	86	89	47	584	674	378	89	78	40.3
8-731-50	8-731-50G	48-51	203	203	60	100	95	54	682	798	431	101	91	66.4

★S.C. = Self Colored.

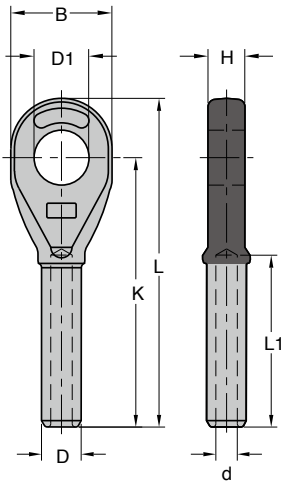

- YOKE 8-732 Closed Swage are forged from special bar quality carbon steel with very finest hardness controlled by spheroidize annealing.
- YOKE Swage properly applied have an efficiency rating of 100% based on the catalog strength of wire rope.
- YOKE Swage are recommended for use with 6x19, 6x36, and IWRC wire rope. They are approved for use with galvanized bridge rope.
- YOKE Swage sockets are not recommended for use on fiber core or lang lay rope.
- Galvanized finish.

All slings swaged with sockets shall be proof loaded in accordance with ASME B30.9

Forged Closed Swage Wire Rope Socket

Item No.		Rope Size	Before Swage Dimensions (inch)								Max. After Swage Dim.	N.W.
S.C.*	Galvanized	inch	B	D	D1	d	H	K	L	L1	inch	lbs
8-732-06	8-732-06G	1/4	1.38	0.50	0.75	0.27	0.50	3.50	4.33	2.13	0.46	0.4
8-732-08	8-732-08G	5/16	1.63	0.77	0.89	0.34	0.67	4.50	5.50	3.15	0.71	0.7
8-732-10	8-732-10G	3/8	1.63	0.77	0.89	0.41	0.67	4.50	5.50	3.15	0.71	0.7
8-732-11	8-732-11G	7/16	2.00	0.98	1.06	0.48	0.89	5.75	6.93	4.25	0.91	1.5
8-732-13	8-732-13G	1/2	2.00	0.98	1.06	0.55	0.89	5.75	6.93	4.25	0.91	1.3
8-732-14	8-732-14G	9/16	2.40	1.25	1.26	0.62	1.14	7.28	8.70	5.31	1.16	3.1
8-732-16	8-732-16G	5/8	2.40	1.25	1.26	0.67	1.14	7.28	8.70	5.31	1.16	2.9
8-732-19	8-732-19G	3/4	2.87	1.55	1.44	0.82	1.31	8.54	10.20	6.38	1.42	5.1
8-732-22	8-732-22G	7/8	3.11	1.70	1.70	0.94	1.50	10.16	11.97	7.44	1.55	6.8
8-732-26	8-732-26G	1	3.62	1.98	2.05	1.06	1.77	11.54	13.46	8.50	1.80	10.6
8-732-28	8-732-28G	1 1/8	4.02	2.25	2.32	1.19	2.00	12.72	15.04	9.57	2.05	14.7
8-732-32	8-732-32G	1 1/4	4.50	2.53	2.56	1.33	2.25	14.33	16.97	10.63	2.30	21.6
8-732-36	8-732-36G	1 3/8	5.00	2.80	2.56	1.45	2.25	15.83	18.70	11.69	2.56	28.6
8-732-38	8-732-38G	1 1/2	5.50	3.08	2.81	1.61	2.52	17.01	20.12	12.75	2.81	38.1
8-732-45	8-732-45G	1 3/4	6.26	3.39	3.54	1.86	3.00	20.00	23.54	14.88	3.06	52.8
8-732-50	8-732-50G	2	7.24	3.94	3.82	2.13	3.27	23.00	27.64	17.01	3.56	89.1

★S.C. = Self Colored.

Item No.		Rope Size	Before Swage Dimensions (mm)								Max. After Swage Dim.	N.W.
S.C.*	Galvanized	mm	B	D	D1	d	H	K	L	L1	mm	kg
8-732-06	8-732-06G	6- 7	35	13	19	7	13	89	110	54	12	0.2
8-732-08	8-732-08G	8	41	20	22	9	17	114	140	80	18	0.3
8-732-10	8-732-10G	9-10	41	20	22	11	17	114	140	80	18	0.3
8-732-11	8-732-11G	11-12	51	25	27	12	22	146	176	108	23	0.7
8-732-13	8-732-13G	13	51	25	27	14	22	146	176	108	23	0.6
8-732-14	8-732-14G	14-15	61	32	32	16	29	185	221	135	30	1.4
8-732-16	8-732-16G	16	61	32	32	17	29	185	221	135	30	1.3
8-732-19	8-732-19G	18-20	73	39	36	21	33	217	259	162	36	2.3
8-732-22	8-732-22G	22-23	79	43	43	24	38	258	304	189	39	3.1
8-732-26	8-732-26G	24-25	92	50	52	27	45	293	342	216	46	4.7
8-732-28	8-732-28G	28	102	57	59	30	51	323	382	243	52	6.7
8-732-32	8-732-32G	32	114	64	65	34	57	364	431	270	58	9.8
8-732-36	8-732-36G	35-36	127	71	65	37	57	402	475	297	65	13.0
8-732-38	8-732-38G	38	140	78	71	41	64	432	511	323	71	17.3
8-732-45	8-732-45G	44-45	159	86	90	47	76	508	598	378	78	24.0
8-732-50	8-732-50G	48-51	184	100	97	54	83	584	702	432	90	40.5

★S.C. = Self Colored.

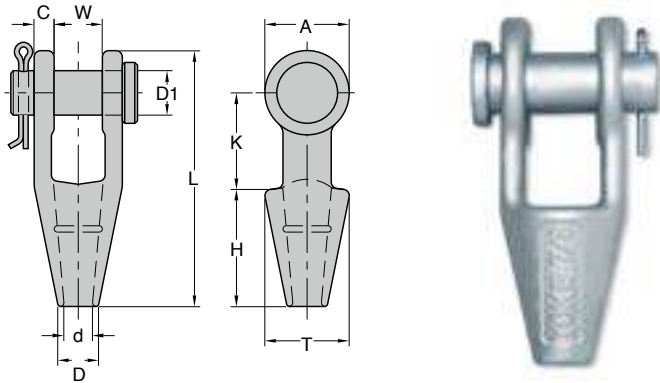

- YOKE Spelter Sockets are forged from special bar quality carbon steel with very finest hardness controlled.
- YOKE Spelter Sockets properly applied have an efficiency rating of 100% based on the catalog strength of wire rope.
- Socket size 1/4" thru 3/4" use one groove, 7/8" thru 1-1/2" use 2 grooves.
- Open Spelter sockets meet the performance requirements of Federal Specification RR-S-550E, Type A.
- Galvanized finish.

In accordance with ASME B30.9, all assembly slings with poured Spelter shall be proof loaded.

Forged Open Spelter Wire Rope Socket with Round Pin

Item No.		Rope Dia.	Structural Strand Dia.	Ultimate Load	Dimensions (inch)										N.W.
S.C.*	Galvanized	inch	inch	tonnes	A	C	D	D1	d	H	K	L	T	W	lbs
8-734-06	8-734-06G	1/4	-	8	1.31	0.35	0.71	0.67	0.43	2.25	1.56	4.65	1.54	0.91	1.1
8-734-10	8-734-10G	5/16 - 3/8	-	12	1.50	0.44	0.83	0.79	0.51	2.25	1.77	4.84	1.73	0.83	1.3
8-734-13	8-734-13G	7/16 - 1/2	-	20	1.91	0.50	0.98	0.98	0.56	2.48	2.13	5.62	1.96	1.00	2.4
8-734-16	8-734-16G	9/16 - 5/8	1/2	27	2.28	0.55	1.14	1.19	0.70	3.00	2.52	6.77	2.25	1.26	4.0
8-734-19	8-734-19G	3/4	9/16 - 5/8	43	2.64	0.62	1.26	1.38	0.81	3.62	3.00	7.96	2.64	1.50	5.7
8-734-22	8-734-22G	7/8	11/16 - 3/4	55	3.17	0.80	1.50	1.63	0.94	4.02	3.50	9.25	3.35	1.77	10.3
8-734-26	8-734-26G	1	13/16 - 7/8	76	3.78	0.91	1.75	2.00	1.14	4.48	4.02	10.55	3.75	2.05	16.3
8-734-28	8-734-28G	1 1/8	15/16 - 1	92	4.12	1.00	2.00	2.25	1.26	5.00	4.62	11.81	4.12	2.25	22.2
8-734-36	8-734-36G	1 1/4 - 1 3/8	1 1/16 - 1 1/8	136	4.75	1.14	2.25	2.50	1.50	5.51	5.00	13.20	4.72	2.52	32.8
8-734-38	8-734-38G	1 1/2	1 3/16 - 1 1/4	170	5.38	1.19	2.75	2.75	1.63	6.00	6.00	15.12	5.25	3.00	45.5

*S.C. = Self Colored.

Item No.		Rope Dia.	Structural Strand Dia.	Ultimate Load	Dimensions (mm)										N.W.
S.C.*	Galvanized	mm	mm	tonnes	A	C	D	D1	d	H	K	L	T	W	kg
8-734-06	8-734-06G	6 - 7	-	8	33	9	18	17	11	57	40	115	39	23	0.5
8-734-10	8-734-10G	8 - 10	-	12	38	11	21	20	13	57	45	123	44	21	0.6
8-734-13	8-734-13G	11 - 13	-	20	48	13	25	25	15	63	54	142	50	25	1.1
8-734-16	8-734-16G	14 - 16	13	27	58	14	29	30	18	76	64	172	57	32	1.8
8-734-19	8-734-19G	18 - 20	14 - 16	43	67	16	32	35	22	92	76	202	67	38	2.6
8-734-22	8-734-22G	22 - 23	18 - 20	55	80	20	38	41	24	102	89	235	85	45	4.7
8-734-26	8-734-26G	24 - 26	22 - 23	76	96	23	44	51	29	114	102	268	95	52	7.4
8-734-28	8-734-28G	28 - 30	24 - 25	92	105	25	51	56	32	127	117	300	105	57	10.1
8-734-36	8-734-36G	32 - 35	26 - 28	136	121	29	57	62	38	140	127	335	120	64	14.9
8-734-38	8-734-38G	36 - 39	30 - 32	170	137	30	70	70	41	152	152	384	133	76	20.7

*S.C. = Self Colored.

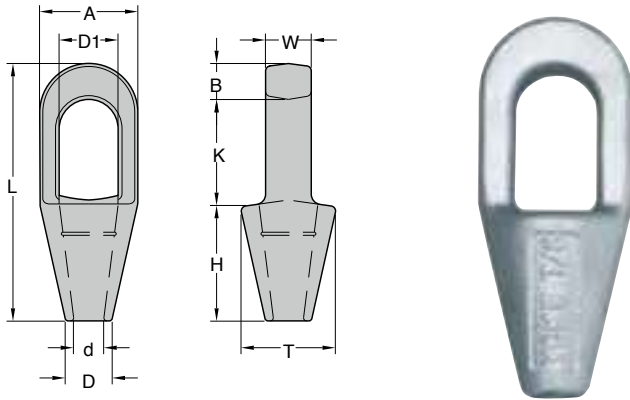

- YOKE Spelter Sockets are forged steel socket through 1-1/2", cast steel 1-5/8" up to 3-3/4".
- YOKE Spelter Sockets properly applied have an efficiency rating of 100% based on the catalog strength of wire rope.
- Socket size 1/4" thru 3/4" use one groove, 7/8" thru 1-1/2" use 2 grooves.
- Closed Spelter sockets meet the performance requirements of Federal Specification RR-S-550E ,Type B.

Forged Closed Spelter Wire Rope Socket

In accordance with ASME B30.9, all assembly slings with poured spelter shall be proof loaded.

Item No.	Rope Dia.	Structural Strand Dia.	Ultimate Load	Dimensions (inch)											N.W.
S.C.*	Galvanized	inch	inch	tonnes	A	B	D	D1	d	H	K	L	T	W	lbs
8-735-06	8-735-06G	1/4	-	8	1.50	0.50	0.71	0.88	0.43	2.25	1.73	4.50	1.50	0.50	0.7
8-735-10	8-735-10G	5/16 - 3/8	-	12	1.69	0.62	0.83	0.98	0.50	2.25	2.00	4.88	1.70	0.71	0.9
8-735-13	8-735-13G	7/16 - 1/2	-	20	2.00	0.71	0.98	1.19	0.55	2.52	2.25	5.43	1.96	0.87	1.5
8-735-16	8-735-16G	9/16 - 5/8	1/2	30.8	2.63	0.83	1.12	1.41	0.71	3.00	2.52	6.31	2.50	0.98	2.6
8-735-19	8-735-19G	3/4	9/16 - 5/8	43.5	3.00	1.06	1.26	1.61	0.81	3.50	3.00	7.58	2.75	1.26	4.4
8-735-22	8-735-22G	7/8	11/16 - 3/4	65.3	3.63	1.26	1.50	1.89	0.94	3.98	3.50	8.75	3.46	1.50	7.9
8-735-26	8-735-26G	1	13/16 - 7/8	81.6	4.13	1.38	1.77	2.28	1.14	4.50	4.02	9.88	3.78	1.77	10.8
8-735-28	8-735-28G	1 1/8	15/16 - 1	100	4.50	1.50	2.00	2.56	1.26	5.00	4.50	10.98	4.12	2.00	15.8
8-735-36	8-735-36G	1 1/4 - 1 3/8	1 1/16 - 1 1/8	136	5.31	1.63	2.25	2.80	1.50	5.50	5.00	12.31	4.75	2.25	23.1
8-735-38	8-735-38G	1 1/2	1 3/16 - 1 1/4	170	5.31	1.93	2.75	3.19	1.63	6.00	6.00	13.94	5.25	2.52	31.5

*S.C. = Self Colored.

Item No.	Rope Dia.	Structural Strand Dia.	Ultimate Load	Dimensions (mm)											N.W.
S.C.*	Galvanized	mm	mm	tonnes	A	B	D	D1	d	H	K	L	T	W	kg
8-735-06	8-735-06G	6 - 7	-	8	38	13	18	22	11	57	44	114	38	13	0.3
8-735-10	8-735-10G	8-10	-	12	43	16	21	25	13	57	51	124	43	18	0.4
8-735-13	8-735-13G	11-13	-	20	51	18	25	30	14	64	57	138	50	22	0.7
8-735-16	8-735-16G	14-16	13	30.8	67	21	28	36	18	76	64	160	63	25	1.2
8-735-19	8-735-19G	18-20	14-16	43.5	76	27	32	41	21	89	76	192	70	32	2.0
8-735-22	8-735-22G	22-23	18-20	65.3	92	32	38	48	24	101	89	222	88	38	3.6
8-735-26	8-735-26G	24-26	22-23	81.6	104	35	45	58	29	114	102	251	96	45	4.9
8-735-28	8-735-28G	28-30	24-25	100	114	38	51	65	32	127	114	279	105	50	7.2
8-735-36	8-735-36G	32-35	26-28	136	135	41	57	71	38	140	127	308	121	57	10.5
8-735-38	8-735-38G	36-39	30-32	170	135	49	70	81	41	152	152	354	133	64	14.3

*S.C. = Self Colored.



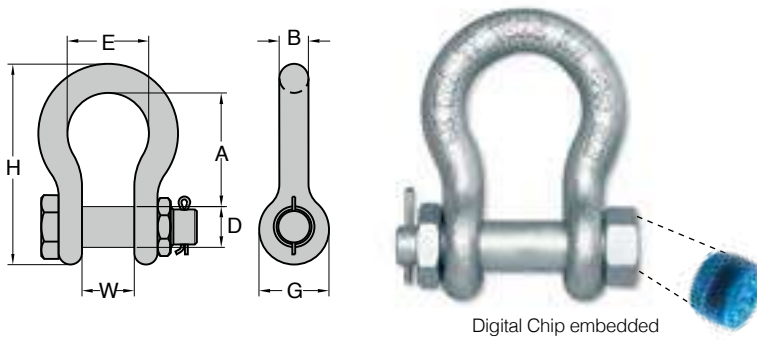

- Shackles are Type Approved by DNV & ABS.
- Shackles are forged alloy steel with alloy pin.
- Size and the Working Load Limit permanently shown on each shackle.
- All shackles with Batch Code which links to Test Certificate and quality traceability.
- 100% magnaflux crack detection during manufacturing.
- 20,000 cycle fatigue rated to 1.5 times Working Load Limit.
- Galvanized finish.
- Digital Chip embedded with Certificate.

YOKE 8-808 Bolt Type Anchor Shackles meet the performance requirements of Federal Specification RR-C-271F, Type 4A , Grade B, Class 3.

Digital Chip embedded with Certificate for serial Traceability

Forged Alloy Anchor Shackle with Bolt Pin

Item No.	Nominal Size	Working Load Limit	Dimensions (inch)							N.W.
	inch		tonnes*	A	B	D	E	G	H	
8-808-08	5/16	1.2	1.22	0.31	0.37	0.82	0.75	2.13	0.47	0.2
8-808-10	3/8	2.0	1.42	0.39	0.43	1.02	0.91	2.56	0.63	0.2
8-808-11	7/16	2.7	1.70	0.43	0.51	1.18	1.06	2.95	0.75	0.4
8-808-13	1/2	3.3	1.85	0.52	0.63	1.30	1.18	3.34	0.79	0.7
8-808-16	5/8	5.0	2.40	0.63	0.75	1.77	1.53	4.21	1.06	1.5
8-808-19	3/4	7.0	2.83	0.75	0.87	1.97	1.81	5.04	1.30	2.2
8-808-22	7/8	9.5	3.39	0.87	1.02	2.28	2.09	5.91	1.50	3.7
8-808-26	1	12.5	3.78	1.02	1.10	2.68	2.36	6.57	1.73	5.3
8-808-28	1 1/8	15.0	4.37	1.10	1.26	2.91	2.68	7.52	1.81	7.5
8-808-32	1 1/4	18.0	4.76	1.26	1.42	3.22	2.99	8.07	2.12	10.6
8-808-36	1 3/8	21.0	5.28	1.42	1.50	3.62	3.31	9.13	2.32	14.3
8-808-38	1 1/2	30.0	5.57	1.50	1.77	3.90	3.62	10.00	2.36	19.1
8-808-45	1 3/4	40.0	7.00	1.85	2.00	5.00	4.17	12.32	2.87	38.5
8-808-50	2	55.0	7.76	2.09	2.24	5.75	4.80	13.66	3.27	53.2

Item No.	Nominal Size	Working Load Limit	Dimensions (mm)							N.W.
	mm		tonnes*	A	B	D	E	G	H	
8-808-08	8	1.2	31	8	9.5	21	19	54	13	0.1
8-808-10	10	2.0	36	10	11	26	23	65	16	0.1
8-808-11	11	2.7	43	11	13	30	27	75	19	0.2
8-808-13	13	3.3	47	13	16	33	30	85	20	0.3
8-808-16	16	5.0	61	16	19	43	39	107	27	0.7
8-808-19	19	7.0	72	19	22	50	46	126	33	1.0
8-808-22	22	9.5	86	22	26	58	53	148	38	1.7
8-808-26	26	12.5	96	26	28	68	60	166	44	2.4
8-808-28	28	15.0	111	28	32	74	68	190	46	3.4
8-808-32	32	18.0	121	32	36	82	76	210	54	4.8
8-808-36	36	21.0	134	36	38	92	84	232	59	6.5
8-808-38	38	30.0	146	38	45	99	92	254	60	8.7
8-808-45	45	40.0	178	47	51	127	106	313	73	17.5
8-808-50	50	55.0	197	53	57	146	122	347	83	24.2

★Minimum Ultimate Load is 5 times the Working Load Limit.
 Maximum Proof Load is 2 times the Working Load Limit.

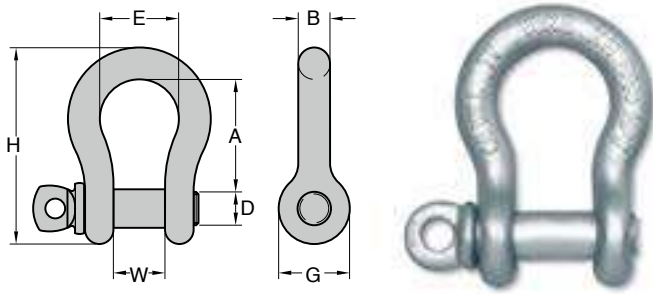

- Shackles are Type Approved by DNV & ABS.
- Shackles are forged alloy steel with alloy pin.
- Size and the Working Load Limit permanently shown on each shackle.
- All shackles with Batch Code which links to Test Certificate and quality traceability.
- 100% magnaflux crack detection during manufacturing.
- 20,000 cycle fatigue rated to 1.5 times Working Load Limit.
- Galvanized finish.

YOKE 8-807 Pin Type Anchor Shackles meet the performance requirements of Federal Specification RR-C-271F, Type 4A , Grade B, Class 3.

Forged Alloy Anchor Shackle with Screw Pin

Item No.	Nominal Size	Working Load Limit	Dimensions (inch)							N.W.
	inch		tonnes*	A	B	D	E	G	H	
8-807-08	5/16	1.2	1.22	0.31	0.37	0.83	0.75	2.13	0.47	0.2
8-807-10	3/8	2.0	1.42	0.39	0.43	1.02	0.91	2.56	0.63	0.2
8-807-11	7/16	2.7	1.70	0.43	0.51	1.18	1.06	2.95	0.75	0.4
8-807-13	1/2	3.3	1.85	0.52	0.63	1.30	1.18	3.34	0.79	0.7
8-807-16	5/8	5.0	2.40	0.63	0.75	1.77	1.53	4.21	1.06	1.3
8-807-19	3/4	7.0	2.83	0.75	0.87	1.97	1.81	4.96	1.30	2.2
8-807-22	7/8	9.5	3.39	0.87	1.02	2.28	2.09	5.82	1.50	3.3
8-807-26	1	12.5	3.78	1.02	1.10	2.68	2.36	6.53	1.73	5.1
8-807-28	1 1/8	15.0	4.37	1.10	1.26	2.91	2.68	7.48	1.81	7.0
8-807-32	1 1/4	18.0	4.76	1.26	1.42	3.22	2.99	8.26	2.12	9.7
8-807-36	1 3/8	21.0	5.28	1.42	1.50	3.62	3.31	9.13	2.32	13.2

Item No.	Nominal Size	Working Load Limit	Dimensions (mm)							N.W.
	mm		tonnes*	A	B	D	E	G	H	
8-807-08	8	1.2	31	8	9.5	21	19	54	12	0.1
8-807-10	10	2.0	36	10	11	26	23	65	16	0.1
8-807-11	11	2.7	43	11	13	30	27	75	19	0.2
8-807-13	13	3.3	47	13	16	33	30	85	20	0.3
8-807-16	16	5.0	61	16	19	43	39	107	27	0.6
8-807-19	19	7.0	72	19	22	50	46	126	33	1.0
8-807-22	22	9.5	86	22	26	58	53	148	38	1.5
8-807-26	26	12.5	96	26	28	68	60	166	44	2.3
8-807-28	28	15.0	111	28	32	74	68	190	46	3.2
8-807-32	32	18.0	121	32	36	84	76	210	54	4.4
8-807-36	36	21.0	134	36	38	92	84	232	59	6.0

★Minimum Ultimate Load is 5 times the Working Load Limit.
Maximun Proof Load is 2 times the Working Load Limit.

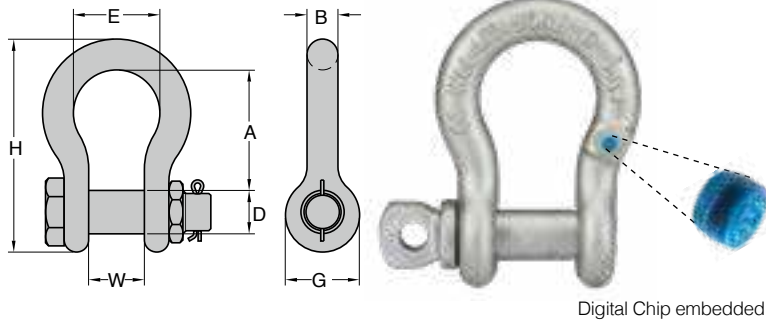

- Shackles are Type Approved by CE & UKCA.
- Shackles are forged carbon steel with alloy pin.
- Size and the Working Load Limit permanently shown on each shackle.
- All shackles with Batch Code which links to Test Certificate and quality traceability.
- 100% magnaflux crack detection during manufacturing.
- 20,000 cycle fatigue rated to 1.5 times Working Load Limit.
- Galvanized finish.

YOKE 8-837 Carbon Bolt Type Anchor Shackles meet the performance requirements of US Federal Specification RR-C-271, Type 4A, Grade A, Class 2.

Digital Chip embedded with Certificate for serial Traceability

Forged Anchor Shackle
with Bolt Pin. Carbon Steel

Item No.	Nominal Size	Working Load Limit	Dimensions (inch)							N.W.
	inch		tonnes*	A	B	D	E	G	H	W
8-838-08	5/16	0.75	1.22	0.31	0.37	0.82	0.75	2.13	0.47	0.2
8-838-10	3/8	1.00	1.42	0.39	0.43	1.02	0.91	2.56	0.63	0.2
8-838-11	7/16	1.50	1.70	0.43	0.51	1.18	1.06	2.95	0.75	0.4
8-838-13	1/2	2.00	1.85	0.52	0.63	1.30	1.18	3.34	0.79	0.9
8-838-16	5/8	3.25	2.40	0.63	0.75	1.70	1.50	4.17	1.06	1.5
8-838-19	3/4	4.75	2.83	0.75	0.87	1.97	1.81	5.04	1.30	2.2
8-838-22	7/8	6.50	3.39	0.87	1.02	2.28	2.09	5.91	1.50	3.7
8-838-26	1	8.50	3.78	1.02	1.10	2.68	2.40	6.57	1.73	5.3
8-838-28	1 1/8	9.50	4.37	1.10	1.26	2.91	2.68	7.52	1.81	7.5
8-838-32	1 1/4	12.00	4.76	1.26	1.42	3.30	2.99	8.07	2.12	10.6
8-838-36	1 3/8	13.50	5.28	1.42	1.50	3.62	3.31	9.13	2.32	14.3
8-838-38	1 1/2	17.00	5.57	1.50	1.77	3.90	3.62	10.00	2.36	19.4
8-838-45	1 3/4	25.00	7.00	1.85	2.00	5.00	4.17	12.32	2.87	38.5
8-838-50	2	35.00	7.76	2.09	2.24	5.75	4.80	13.66	3.27	53.2

Item No.	Nominal Size	Working Load Limit	Dimensions (mm)							N.W.
	mm		tonnes*	A	B	D	E	G	H	W
8-838-08	8	0.75	31	8	9.5	21	19	54	12	0.1
8-838-10	10	1	36	10	11	26	23	65	16	0.1
8-838-11	11	1.5	43	11	13	30	27	75	19	0.2
8-838-13	13	2	47	13	16	33	30	85	20	0.4
8-838-16	16	3.25	61	16	19	43	38	106	27	0.7
8-838-19	19	4.75	72	19	22	50	46	126	33	1.0
8-838-22	22	6.5	86	22	26	58	53	148	38	1.7
8-838-26	26	8.5	96	26	28	68	61	166	44	2.4
8-838-28	28	9.5	111	28	32	74	68	190	46	3.4
8-838-32	32	12	121	32	36	84	76	210	54	4.8
8-838-36	36	13.5	134	36	38	92	84	232	59	6.5
8-838-38	38	17	146	38	45	99	92	254	60	8.8
8-838-45	45	25	178	47	51	127	106	313	73	17.5
8-838-50	50	35	197	53	57	146	122	347	83	24.2

★Minimum Ultimate Load is 6 times the Working Load Limit.
Maximun Proof Load is 2 times the Working Load Limit.

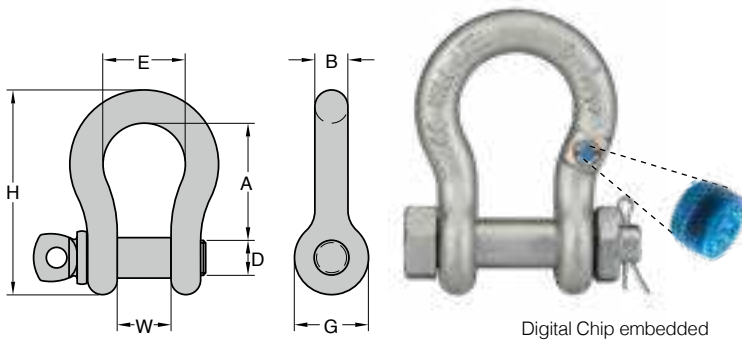

Digital Chip embedded

YOKE 8-838 Carbon Bolt Type Anchor Shackles meet the performance requirements of US Federal Specification RR-C-271, Type 4A, Grade A, Class 3.

- Shackles are Type Approved by CE & UKCA & DNV.
- Shackles are forged carbon steel with alloy pin.
- Size and the Working Load Limit permanently shown on each shackle.
- All shackles with Batch Code which links to Test Certificate and quality traceability.
- 100% magnaflux crack detection during manufacturing.
- 20,000 cycle fatigue rated to 1.5 times Working Load Limit.
- Galvanized finish.
- Digital Chip embedded with Certificate.

Forged Anchor Shackle with Screw Pin. Carbon Steel

Item No.	Nominal Size	Working Load Limit tonnes*	Dimensions (inch)							N.W. lbs
	inch		A	B	D	E	G	H	W	
8-837-05	3/16	0.30	0.87	0.2	0.25	0.69	0.57	1.48	0.38	0.05
8-837-06	1/4	0.50	1.10	0.26	0.32	0.80	0.63	1.85	0.47	0.1
8-837-08	5/16	0.75	1.22	0.31	0.37	0.82	0.75	2.13	0.47	0.2
8-837-10	3/8	1.00	1.42	0.39	0.43	1.02	0.91	2.56	0.63	0.2
8-837-11	7/16	1.50	1.70	0.43	0.51	1.18	1.06	2.95	0.75	0.4
8-837-13	1/2	2.00	1.85	0.52	0.63	1.30	1.18	3.34	0.79	0.7
8-837-16	5/8	3.25	2.40	0.63	0.75	1.70	1.50	4.17	1.06	1.3
8-837-19	3/4	4.75	2.83	0.75	0.87	1.96	1.81	5.04	1.30	2.2
8-837-22	7/8	6.50	3.39	0.87	1.02	2.28	2.08	5.91	1.50	3.3
8-837-26	1	8.50	3.78	1.02	1.10	2.68	2.67	6.57	1.73	5.1
8-837-28	1 1/8	9.50	4.37	1.10	1.26	2.91	2.68	7.52	1.81	7.0
8-837-32	1 1/4	12.00	4.76	1.26	1.42	3.30	2.99	8.07	2.12	9.9
8-837-36	1 3/8	13.50	5.28	1.42	1.50	3.62	3.30	9.13	2.32	13.9
8-837-38	1 1/2	17.00	5.75	1.50	1.77	3.90	3.62	10.00	2.36	17.8
8-837-45	1 3/4	25.00	7.00	1.85	2.00	5.00	4.17	12.32	2.87	35.9
8-837-50	2	35.00	7.76	2.09	2.24	5.75	4.80	13.66	3.27	51.0

Item No.	Nominal Size	Working Load Limit tonnes*	Dimensions (mm)							N.W. kg
	mm		A	B	D	E	G	H	W	
8-837-05	5	0.30	22	5	6.0	17	15	38	10	0.021
8-837-06	6	0.50	28	6.5	8.0	20	16	47	12	0.05
8-837-08	8	0.75	31	8	9.5	21	19	54	12	0.1
8-837-10	10	1.00	36	10	11.0	26	23	65	16	0.1
8-837-11	11	1.50	43	11	13.0	30	27	75	19	0.2
8-837-13	13	2.00	47	13	16.0	33	30	85	20	0.3
8-837-16	16	3.25	61	16	19.0	43	38	106	27	0.6
8-837-19	19	4.75	72	19	22.0	50	46	126	33	1.0
8-837-22	22	6.50	86	22	26.0	58	53	148	38	1.5
8-837-26	26	8.50	96	26	28.0	69	61	166	44	2.3
8-837-28	28	9.50	111	28	32.0	74	68	190	46	3.2
8-837-32	32	12.00	121	32	36.0	84	76	210	54	4.5
8-837-36	36	13.50	134	36	38.0	92	84	232	59	6.3
8-837-38	38	17.00	146	38	45.0	99	92	254	60	8.1
8-837-45	45	25.00	178	47	51.0	127	106	313	73	16.3
8-837-50	50	35.00	197	53	57.0	146	122	347	83	23.2

★ Minimum Ultimate Load is 6 times the Working Load Limit.
Maximum Proof Load is 2 times the Working Load Limit.

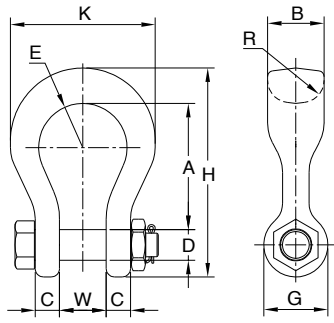

Fig. 1

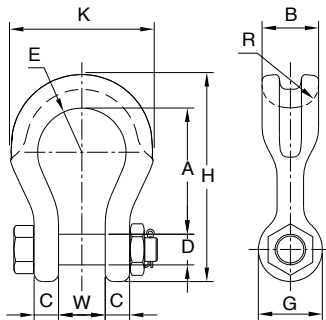

Fig. 2



- Shackles are forged alloy steel with alloy pin.
- Size and the Working Load Limit permanently shown on each shackle.
- All shackles with Batch Code which links to Test Certificate and quality traceability.
- 100% magnaflux crack detection during manufacturing.
- 20,000 cycle fatigue rated to 1.5 times Working Load Limit.
- Galvanized finish.
- Digital Chip embedded with Certificate.

Digital Chip embedded with Certificate for serial Traceability

Forged Alloy Wide Body Shackle with Bolt Pin

Item No.	Nominal Size	Working Load Limit	Dimensions (inch)										N.W.
	inch		tonnes*	A	B	C	D	E	G	H	K	R	
8-809-19	3/4	7	3.58	1.61	0.70	0.87	1.26	1.81	5.90	4.09	1.26	1.30	3.7
8-809-26	1	12.5	4.64	2.12	0.91	1.14	1.61	2.40	7.64	5.51	1.38	1.73	8.4
8-809-32	1 1/4	18	5.83	2.52	1.18	1.42	2.00	2.68	9.37	6.77	1.50	2.13	14.7
8-809-38	1 1/2	30	6.93	3.15	1.38	1.77	2.50	3.50	11.38	8.50	1.77	2.36	27.5

★Minimum Ultimate Load is 5 times the Working Load Limit.
 Maximun Proof Load is 2 times the Working Load Limit.

★8-809-19/-26 See Figure 1
 ★8-809-32/-38 See Figure 2

Item No.	Nominal Size	Working Load Limit	Dimensions (mm)										N.W.
	mm		tonnes*	A	B	C	D	E	G	H	K	R	
8-809-19	19	7	91	41	18	22	32	46	150	104	32	33	1.7
8-809-26	26	12.5	118	54	23	29	41	61	194	140	35	44	3.8
8-809-32	32	18	148	64	30	36	51	68	238	172	38	54	6.7
8-809-38	38	30	176	80	35	45	64	89	289	216	45	60	12.5

★Minimum Ultimate Load is 5 times the Working Load Limit.
 Maximun Proof Load is 2 times the Working Load Limit.



Wire Rope Clip

- Galvanized finish.
- Forged base for full range of sizes.
- According to the breaking load of the wire rope, YOKE wire rope clips have an efficiency rating of 80% for 1/8" - 7/8" sizes, and 90% for sizes 1" up to 3".
- Manufactured with or exceeds all requirements of ASME B30.26 and EN13411 -2003.

Yoke Wire Rope Clip in accordance with FF-C-450 TYPE 1 CLASS 1 and EN13411-2003.

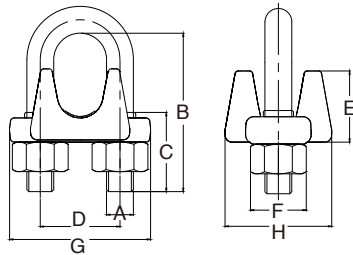

Wire Rope Clip

Item No.	Size		Dimensions (mm)								N.W kg
	mm	inch	A	B	C	D	E	F	G	H	
8-762-03	3-4	1/8	5	25	12	12	10	9	12	26	0.03
8-762-05	5	3/16	5	30	14	15	13	13	15	31	0.04
8-762-06	6-7	1/4	7	33	15	19	17	14	19	37	0.09
8-762-08	8	5/16	8	35	19	22	19	17	23	43	0.14
8-762-10	9-10	3/8	9	38	19	25	24	19	30	51	0.23
8-762-11	11	7/16	11	48	25	30	29	22	37	59	0.37
8-762-13	12-13	1/2	11	48	25	30	29	22	37	58	0.37
8-762-14	14-15	9/16	13	61	32	33	31	24	41	64	0.48
8-762-16	16	5/8	13	61	32	33	35	24	41	64	0.48
8-762-19	18-20	3/4	14	70	37	38	35	27	57	72	0.68
8-762-22	22	7/8	17	79	41	45	38	32	53	81	1.00
8-762-26	24-26	1	17	89	46	48	43	32	60	89	1.21
8-762-28	28-30	1 1/8	17	99	51	51	50	32	64	92	1.36
8-762-32	32-34	1 1/4	20	108	54	59	55	37	74	105	2.08
8-762-36	36	1 3/8	20	108	54	59	58	37	78	106	2.23
8-762-38	38	1 1/2	20	125	61	67	61	37	85	113	2.48
8-762-42	41-42	1 5/8	22	135	67	70	68	41	90	122	3.28
8-762-45	44-46	1 3/4	24	146	70	78	76	46	97	134	4.28
8-762-50	48-52	2	32	164	76	86	78	51	110	150	6.25
8-762-57	56-58	2 1/4	32	179	93	99	82	51	114	166	7.10
8-762-64	62-65	2 1/2	32	193	95	105	93	51	128	170	7.88
8-762-70	68-72	2 3/4	32	208	97	111	105	51	137	178	9.56
8-762-75	75-78	3	38	232	104	120	115	61	150	194	14.80



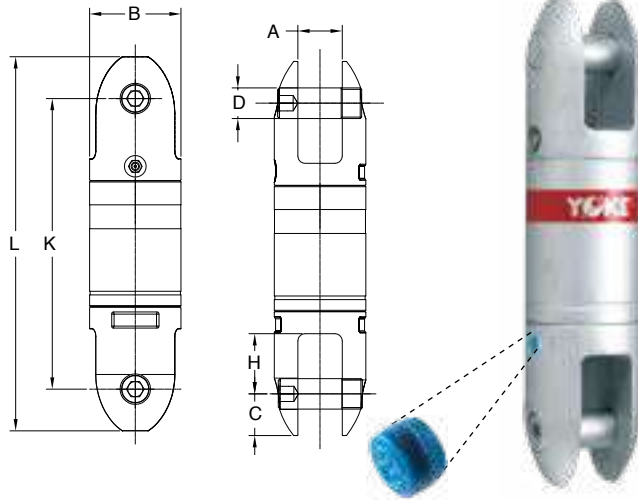

Digital Chip embedded

- YOKE Swivels are manufactured using the highest grade of material available.
- YOKE Swivels are designed with a safety factor of 5:1.
- YOKE Swivels are available in sizes from 3/4 Tons to 35 Tons.
- YOKE Swivels are available for wire lines 1/4" to 1-1/2".
- YOKE Swivels are zinc plated for corrosion resistance and longer life.
- YOKE Swivels are manufactured with grease fittings for superior performance.
- YOKE Swivels are designed for low starting torque and high rotation speed.
- All Swivels parts are 100% magnaflux crack detected.
- 20,000 cycle fatigue rate to 1.5 times working load limit.
- All parts with batch number for quality certified and traceability.
- Digital Chip embedded with Certificate.

Digital Chip embedded with Certificate for serial Traceability

Angular Contact Bearing Swivels - Bullet Style

Item No.	Wire Line Size	Working Load Limit	Dimensions (inch)							N.W.
	inch		tonnes*	B	K	L	C	A	D	
8-301-0075	1/4	0.75	1.30	4.00	5.00	0.50	0.60	0.40	0.90	1.1
8-301-015	3/8	1.50	1.60	4.40	5.70	0.60	0.70	0.50	1.00	1.7
8-301-03	1/2	3.00	2.00	6.30	8.00	0.90	0.90	0.60	1.20	4.4
8-301-05	5/8	5.00	2.50	8.00	10.30	1.20	1.30	0.90	1.50	8.7
8-301-085	3/4	8.50	3.00	9.50	12.30	1.40	1.50	1.00	2.00	14.8
8-301-10	7/8	10.00	4.00	12.50	16.00	1.80	1.70	1.50	2.10	40.0
8-301-15	1	15.00	4.30	12.50	16.00	1.80	2.00	1.50	2.20	46.2
8-301-25	1 1/4	25.00	5.20	14.70	19.50	2.40	2.50	2.00	2.70	80.5

★Minimum Ultimate Load is 5 times the Working Load Limit.
 Maximun Proof Load is 2 times the Working Load Limit.

Item No.	Wire Line Size	Working Load Limit	Dimensions (mm)							N.W.
	mm		Tons*	B	K	L	C	A	D	
8-301-0075	6	0.75	32	103	126	12	15	10	22	0.5
8-301-015	10	1.50	40	112	144	16	18	11	26	0.8
8-301-03	13	3.00	51	159	203	23	23	16	31	2.0
8-301-05	16	5.00	64	200	262	31	32	22	37	4.0
8-301-085	19	8.50	76	242	312	35	37	25	50	6.7
8-301-10	22	10.00	102	317	408	46	42	38	53	18.2
8-301-15	25	15.00	108	317	408	46	48	38	56	21.0
8-301-25	32	25.00	132	374	495	61	62	51	69	36.5

★Minimum Ultimate Load is 5 times the Working Load Limit.
 Maximun Proof Load is 2 times the Working Load Limit.

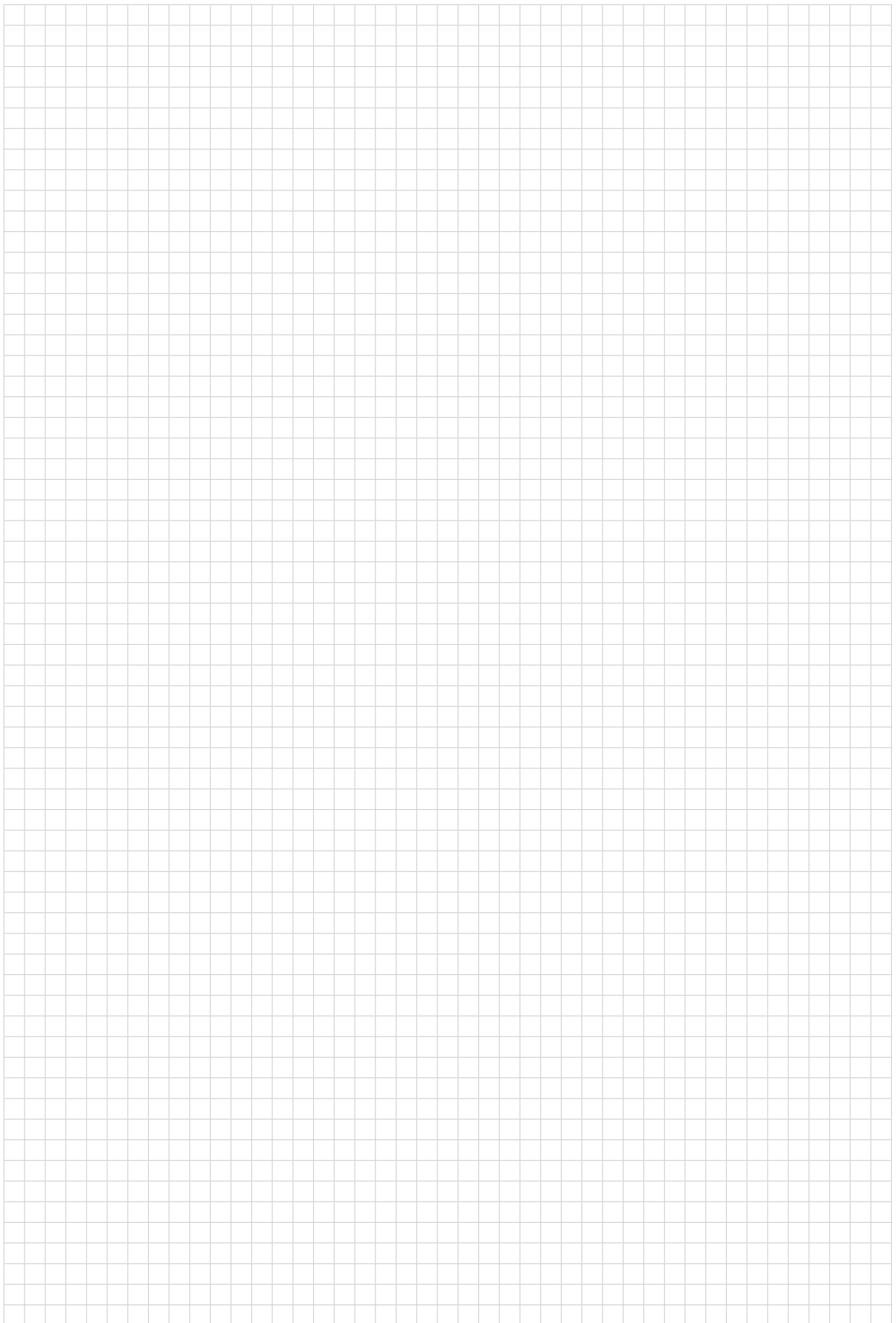

INDEX

By Item. Number					
Item No.	Page	Item No.	Page	Item No.	Page
13234	84	8-251	48	DA-027N	175
13243	80	8-252	52	DA-271	54
13271	81	8-271	40	DA-271	166
13273	81	8-272	42	DA-272	56
13281	83	8-273	44	DA-272	168
13285	82	8-274	46	DA-808	173
13287	83	8-281	64	DA-838	172
13288	82	8-285	65	X-001	95
8-003	146	8-291K	28	X-002	97
8-003F	146	8-291KL	32	X-002W	98
8-015	147	8-292K	30	X-003	103
8-018	148	8-292KL	34	X-004	104
8-023	159	8-301	217	X-006	99
8-024	152	8-501	190	X-006L	100
8-025	149	8-502	191	X-007	96
8-026	149	8-512	198	X-0080	101
8-027	148	8-514	199	X-0081	102
8-027N	148	8-515	200	X-009	105
8-041	153	8-521	202	X-015	110
8-042	153	8-522	203	X-016	138
8-043/S	151	8-523	202	X-019	117
8-044/S	150	8-541	192	X-025	113
8-047	150	8-542	193	X-026	114
8-048	150	8-551	194	X-027	115
8-049N	152	8-552	195	X-027N	116
8-054	159	8-561	196	X-041	128
8-057	73	8-562	197	X-0411	129
8-0573	72	8-591	187	X-042	130
8-0575	74	8-731	205	X-0421	131
8-0576	75	8-732	206	X-043/S	119
8-058	66	8-734	207	X-044/S	118
8-059	147	8-735	208	X-046	127
8-061	153	8-762	215	X-047	126
8-064	152	8-807	211	X-059	139
8-066	151	8-808	210	X-061	132
8-067	154	8-809	214	X-066	140
8-078	154	8-837	213	X-069	133
8-081	71	8-838	212	X-079	106
8-082	76	8-911	181	X-173	123
8-083	70	8-921	182	X-175	124
8-088N	159	8-931	183	X-175N	125
8-097	151	8-941	177	X-950	135
8-123	158	8-941FT	178	X-951	136
8-124	157	8-951	179	X-952N	137
8-173	120	8-951DH	180	X-A04	107
8-175	121	8-M015	147	X-A05	108
8-175N	122	8-P025	142	X-A06	109
8-203	58	8-P025T	142	X-M015	111
8-204	60	8-P044	141	X-P015	141
8-211	16	8-S291	36	X-P026	141
8-211L	20	8-S292	38	X-P950	141
8-212	18	DA-001	170		
8-231	22	DA-007	171		
8-231L	26	DA-018	174		
8-232	24	DA-025	176		



Safety is our first priority™

An ISO 9001 Registered Company

Headquarter

YOKE Industrial Corp.
TEL: +886-4-2350-8088
Email : info@mail.yoke.net

NORTH AMERICA

United States

YOKE Inc.
Tel: +1-206-678-8878
Email: alvin_tanzil@mail.yoke.net

EUROPE

Germany

OSTALBKETTEN GmbH & Co. KG
Tel: +49 (0) 73 61 / 92 45-0
Email: info@ostalbketten.de
www.ostalbketten.de

ASIA

Singapore

Genesis Solutions Pte Ltd
Tel: +65 6261 0626
Email: supply@genesis.work
www.genesis.work

Indonesia

PT YOKE Industrial Indonesia
Tel: +62813-1818-6849
Email: angelina_jeo@mail.yoke.net

China

YOKE LIFTING EQUIPMENT (SHANGHAI)CO.,LTD.
TEL: +86-400-7722-456
Email : info@cnmail.yoke.net

Thailand

YOKE LEE CO., LTD.
Tel: 093-269-3944
Email: amorndej.yokelee@gmail.com
yokelee.com/en

Korea

YOKE Korea Corp.
Tel: +82-55-713-3799
Email: sales@yokekorea.com
www.yokekorea.com

Vietnam

YOKE Vietnam Co., Ltd
Tel: +84-904349877
Email: phuongdong_nguyen@mail.yoke.net

Industrial Membership



Specialized
Carriers
& Rigging
Association